

NICOLAI
D I A M A N T

Tools for Workshop Catalogue 2021 v6.2

Tools for CNC Machines

cut and drill

pag. A2	Fingerbits
pag. A5	Coredrills
pag. A6	Drilling
pag. A7	CNC Blades

profiling

pag. A8	Raccomended Use of Nicolai Wheels
pag. A10	Standard Profiles
pag. A12	J & DJ Series Profile
pag. A13	Corner Breaker
pag. A14	Mitre System
pag. A15	Oversize Profiles
pag. A18	Monumental Tooling
pag. A19	Dm60 Series
pag. A29	Dm60 Series (Electroplated)
pag. A33	Dm40 Series
pag. A36	Dm20 Series
pag. A39	Dm10 Series
pag. A41	Bevelling
pag. A42	Under-Up Mounted

kitchen top

pag. A43	Premium Straight Edge
pag. A44	Flush Fit
pag. A46	Luxury Flush Fit
pag. A48	Square Sinks
pag. A50	Drainboard Processing
pag. A51	Stubbing Wheels
pag. A54	Drainboard
pag. A56	Drainboard Groove

engraving

pag. A60	Widia, PCD Conic Mills
pag. A60	Flat & Round Head Mills
pag. A61	Cylindrical Mills
pag. A61	No Coring Drill Bits

sculpture

pag. A62	Conic Mills
pag. A63	Electroplated Conic Mills
pag. A64	Heavy Metal Conic Mills

special works

pag. A66	Electroplated Fingerbits
pag. A67	Replaceable Electroplated Fingerbits
pag. A68	Ball Head Mills
pag. A69	Incremental Cutting
pag. A70	Crown Mills
pag. A71	Step Cutters
pag. A72	Stubbing Wheels
pag. A74	Horizontal Blades
pag. A75	Kit for Polishing (Not for Flat Surface)

sinks

pag. A76	Tools for Sinks
pag. A77	Granite Sinks
pag. A78	Marble Sinks
pag. A80	Replaceable Head Mills
pag. A81	Extension for Replaceable Head Mills

cones

pag. A82	Cones
pag. A85	Pull Studs
pag. A85	Berg Pinses
pag. A85	Telescopic Cones & Adapter

fixed, telescopic adapt.& polishing tools

A85-B	Fixed & Telescopic Plates
A85-D	Polishing Discs
A85-E	Polishing Frankfurts
A85-F	Tools for Single Head Machines

extensions and adapters

pag. A86	Flange Extensions and Adapters
pag. A88	1/2 Gas Extensions and Adapters
pag. A91	M36 Extensions and Adapters
pag. A93	Adapters

left thread tools

pag. A94	Left Thread Mills
pag. A96	Left Thread CORE BITS



5 axis & Robots

pag. A98	Basic setup guide
----------	-------------------

Edge Working Tools

<i>pag. B2</i>	Edge Polishing Tooling
<i>pag. B3</i>	Tools for Montresor
<i>pag. B4</i>	Tools for SassoMeccanica
<i>pag. B5</i>	Tools for Comandulli
<i>pag. B6</i>	Tools for GMM
<i>pag. B7</i>	Tools for MarmoMeccanica
<i>pag. B8</i>	Tools for OMGM
<i>pag. B9</i>	Tools for Cavani
<i>pag. B10</i>	Tools for CMPI
<i>pag. B11</i>	Tools for CMG
<i>pag. B12</i>	Tools for Breton
<i>pag. B13</i>	Frontal Wheels
<i>pag. B14</i>	Abracadabra Supreme
<i>pag. B16</i>	Abracadabra Edge
<i>pag. B18</i>	ProGlo

Manual Machine Tooling

<i>pag. C2</i>	MARMO/GHINES Wheels
<i>pag. C3</i>	Electroplated MARMO/GHINES Wheels
<i>pag. C4</i>	OMA Wheels
<i>pag. C5</i>	FLEX Wheels
<i>pag. C6</i>	Polishing Discs
<i>pag. C8</i>	Cup & Slot Wheels
<i>pag. C9</i>	Coredrills
<i>pag. C10</i>	Drill Bits for Granite
<i>pag. C11</i>	Anchoring System
<i>pag. C12</i>	Turbo Blades
<i>pag. C13</i>	Electroplated Blades

Blades for Wet Cutting

<i>pag. D2</i>	Zebra & HMB28 blades
<i>pag. D3</i>	Blades for Marble
<i>pag. D4</i>	Blades for Dekton, Neolith & Lapitec

Flat & Profiling Wheels

<i>pag. E2</i>	Grooving Wheels
<i>pag. E4</i>	Lathe Blades
<i>pag. E5</i>	Kit for Polishing Columns
<i>pag. E6</i>	Segmented Profiling Wheels
<i>pag. E8</i>	Electroplated Profiling Wheels

Frames & Skirting Boards

<i>pag. F2</i>	Frames Profiles
<i>pag. F3</i>	Skirting Boards Profiles
<i>pag. F4</i>	Electroplated Wheels
<i>pag. F5</i>	Bamboo Wheels

GR Tools for GRANITE

ES Tools for ENGINEERED STONE

MR Tools for MARBLE

CR Tools for CERAMIC

GL Tools for GLASS

SEG SEGMENTED Tools

FCC CONTINUOUS RIM Tools

ELE ELECTROPLATED Tools

JoyLite™ POLISHING Tools



Tools ADVISED by Nicolai Diamant



LEFT THREAD Tools



Tools to use WITHOUT WATER *



Tools to use WITH WATER *

* **WHEREVER NOT INDICATED THE USE OF WATER IS MANDATORY**



CNC tooling

CUTTING FINGER BITS

cut and drill



WHITE TWIN FINGERBIT

Segmented - F=1/2Gas



CODE	SIZE	RPM	FEED
AFS94010	Ø23 x 30 mm - Z6	4500-5200	250-500 mm/min
AFS94019 ☺	Ø23 x 40 mm - Z6		



YELLOW Z5 FINGERBIT

Segmented - F=1/2Gas



CODE	SIZE	RPM	FEED
AFS91005	Ø23 x 30 mm - Z5	4500-5200	250-500 mm/min
AFS91015 ☺	Ø23 x 40 mm - Z5		
AFS91025	Ø23 x 50 mm - Z5		



BLUE TWIN FINGERBIT

Segmented - F=1/2Gas



CODE	SIZE	RPM	FEED
AFS94011	Ø23 x 30 mm - Z6	4500-5200	250-500 mm/min
AFS90268	Ø23 x 40 mm - Z6		
AFS91074	Ø23 x 50 mm - Z6		



BLUE Z5 FINGERBIT

Segmented - F=1/2Gas



CODE	SIZE	RPM	FEED
AFS90005	Ø23 x 30 mm - Z5	4500-5200	250-500 mm/min
AFS90015	Ø23 x 40 mm - Z5		
AFS90025	Ø23 x 50 mm - Z5		



YELLOW METAL TWIN FINGERBIT

Segmented - F=1/2Gas



CODE	SIZE	RPM	FEED
AFS90284	Ø20x 40 mm - Z6 FB3X NEW	4500-5200	250-500 mm/min

FB3X



YELLOW TWIN FINGERBIT

Segmented - F=1/2Gas



CODE	SIZE	RPM	FEED
AFS94012	Ø23 x 30 mm - Z6	4500-5200	250-500 mm/min
AFS91070 ☺	Ø23 x 40 mm - Z6		
AFS91075	Ø23 x 50 mm - Z6		



8th WONDER FINGERBIT

Segmented - F=1/2Gas



CODE	SIZE	RPM	FEED
AFS90076	Ø23 x 40 mm - Z8	4500-5200	250-500 mm/min
AFS90077	Ø23 x 40 mm - Z8		



☺ = ADVISED

CUTTING FINGER BITS

cut and drill



SMALL DIAMETER FINGERBIT

Segmented - F=1/2Gas

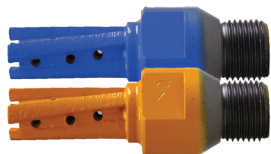

CODE	SIZE	RPM	FEED
DFS31112	Ø18 x 40 mm - Z4	5000-5500	300-500 mm/min
DFS31115 ☺	Ø18 x 40 mm - Z4		



XXX BLACK FINGERBIT

Segmented - F=1/2Gas



CODE	SIZE	RPM	FEED
AFS94X05	Ø24 x 35 mm - Z3	4500-5200	250-500 mm/min



XXX GREEN FINGERBIT

Segmented - F=1/2Gas



CODE	SIZE	RPM	FEED
AFS90X05 ☺	Ø24 x 35 mm - Z3	4500-5200	250-500 mm/min
AFS90X25	Ø24 x 45 mm - Z3		



XXX RED FINGERBIT

Segmented - F=1/2Gas



CODE	SIZE	RPM	FEED
AFS91X05	Ø24 x 35 mm - Z3	4500-5200	250-500 mm/min
AFS91X26	Ø24 x 55 mm - Z3		



	White Twin	Yellow Z5	Blue Twin	Blue Z5	Yellow & Met. Yellow Twin	8th Wonder	Small Diam	XXX Black	XXX Green	XXX Red	Ele Finger	Lilac Z4	Jaguar Z4 FB2	Lilac FB23
Soft GR			✓	✓	✓				✓					
Mid GR		✓	✓	✓	✓	✓			✓	✓			✓	
Hard GR		✓			✓	✓				✓		✓	✓	✓
ES	✓		✓		✓		✓	✓	✓					
Marble											✓			
Ceramic							✓					✓		✓

↑ also advised for Dekton, Lapitec and Neolith

☺ = ADVISED

CUTTING FINGER BITS

cut and drill



ELECTROPLATED FINGERBIT

Electroplated - F=1/2Gas



CODE	SIZE	RPM	FEED
AFE80005	Ø16 x 30 mm		
AFE80010 ☺	Ø16 x 40 mm	4800-5500	250-500 mm/min
AFE80015	Ø16 x 50 mm		



JAGUAR Z4 FB2 FINGERBIT

Segmented - F=1/2Gas



CODE	SIZE	RPM	FEED
AFS90014	Ø23 x 40 mm	4500-5200	350-500 mm/min
AFS90024	Ø23 x 50 mm		



other sizes could be available on request

for CERAMIC MATERIALS
(see also Crown Mills at page A45/A70)

LILAC FB23 FINGERBIT

Segmented - F=1/2Gas

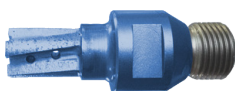

DEKTON Lapitec® NEOLITH
Prestigious Italian Surface EXTRAORDINARY SURFACE

CODE	SIZE	RPM	FEED
AFS90091 ☺	Ø16 x 20 mm - Z4	4500-5200	250-500 mm/min
AFS90128	Ø20 x 25 mm - Z5		
AFS90141 new	Ø20 x 25 mm - Z8	4500-5500	350-500 mm/min
AFS90126	Ø20 x 40 mm - Z5		
AFS90279	Ø23 x 25 mm - Z6 TWIN	4500-5200	250-500 mm/min
AFS9001H ☺	Ø23 x 40 mm - Z5	4500-5200	350-550 mm/min
AFS90272	Ø23 x 40 mm - Z6 TWIN	4500-5200	350-600 mm/min
AFS90143 new	Ø23 x 40 mm - Z8	4500-5200	350-600 mm/min



other sizes could be available on request

	White Twin	Yellow Z5	Blue Twin	Blue Z5	Yellow & Met. Yellow Twin	8th Wonder	Small Diam	XXX Black	XXX Green	XXX Red	Ele Finger	Lilac Z4	Jaguar Z4 FB2	Lilac FB23
Soft GR			✓	✓	✓				✓					
Mid GR		✓	✓	✓	✓	✓			✓	✓			✓	
Hard GR		✓			✓	✓				✓		✓	✓	✓
ES	✓		✓		✓		✓	✓						
Marble											✓			
Ceramic							✓					✓		✓

↑ also advised for **DEKTON Lapitec® NEOLITH**
Prestigious Italian Surface EXTRAORDINARY SURFACE

☺ = ADVISED

COREDRILLS

cut and drill



COREDRILL
Thin Wall
F=1/2Gas



CODE	SIZE	RPM	FEED
APF11010	Ø10 (13/32") x 55/95 mm	2500-3000	50-100 mm/min
APF11020	Ø20 (25/32") x 55/95 mm		
APF11025	Ø25 (1") x 55/95 mm	2600	
APF11030	Ø30 (1-3/16") x 55/95 mm	2400	
APF11035 ☺	Ø35 (1-3/8") x 55/95 mm	2200	40-50 mm/min
APF11040	Ø40 (1-37/64") x 55/95 mm		
APF11050	Ø50 (2") x 55/95 mm	2000	40 mm/min
APF11060	Ø60 (1-3/4") x 55/95 mm		

ALL DIAMETERS available! - BRASS or STAINLESS STEEL CORE upon request



COREDRILL
Segmented
F=1/2Gas

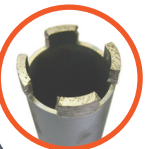

CODE	SIZE	RPM	FEED
APS1B025	Ø25 (1") x 70 mm	2800-3500	
APS1B030	Ø30 (1-3/16") x 70 mm	2500-3000	60-120 mm/min
APS1B035 ☺	Ø35 (1-3/8") x 70 mm		
APS1B050	Ø50 (2") x 70 mm	2000-2500	
APS1B060	Ø60 (1-3/4") x 70 mm	1800-2000	50-100 mm/min
APS1B090	Ø90 (3-35/64") x 70 mm		
APS1B100	Ø100 (4") x 70 mm	1500-1700	30-60 mm/min
APS1B120	Ø120 (4-23/32") x 70 mm		

ALL DIAMETERS available!



COREDRILL for GLASS
Thin Wall
F=1/2Gas



CODE	Ø x Lu/LT	RPM	FEED
APFV7010	Ø10 (13/32") x 30/75 mm	2500-3000	50-100 mm/min
APFV7020	Ø20 (25/32") x 30/75 mm		
APFV7025	Ø25 (1") x 30/75 mm	2600	
APFV7030	Ø30 (1-3/16") x 30/75 mm	2400	
APFV7035 ☺	Ø35 (1-3/8") x 30/75 mm	2200	40-50 mm/min
APFV7040	Ø40 (1-37/64") x 30/75 mm		
APFV7050	Ø50 (2") x 30/75 mm	2000	

ALL DIAMETERS available! - BRASS CORE upon request



COREBITS for CERAMICS
Thin Wall
F=1/2Gas



CODE	Ø x Lu/LT	RPM	FEED
APF11011CER	Ø11 (7/16") x 55/95 mm	2500-3000	50-100 mm/min
APF11015CER	Ø15 (19/32") x 55/95 mm		
APF11016CER	Ø16 (5/8") x 55/95 mm	2600	
APF11022CER	Ø22 (55/64") x 55/95 mm	2200	40-50 mm/min
APF11035CER	Ø35 (1-3/8") x 55/95 mm	2200	40-50 mm/min

ALL DIAMETERS available!



other sizes could be available on request

☺ = ADVISED

DRILLING

cut and drill



COREDRILLS

Electroplated

F=1/2Gas



CODE	SIZE	RPM	FEED
APE12025	Ø25 (1") x 100 mm	2800-3500	60-120 mm/min
APE12030	Ø30 (1-3/16") x 100 mm	2500-3000	
APE12032	Ø32 (1-1/4") x 100 mm		
APE12035	Ø35 (1-3/8") x 100 mm		
APE12038	Ø38 (1-1/2") x 100 mm		
APE12040	Ø40 (1-37/64") x 100 mm		1800-2000
APE12050	Ø50 (2") x 100 mm		
APE12060	Ø60 (1-3/4") x 100 mm		
APE12070	Ø70 (2-49/64") x 100 mm		
APE12080	Ø80 (3-5/32") x 100 mm		
APE12090	Ø90 (3-35/64") x 100 mm		



NO CORING DRILL BITS - 10mm Shank

Segmented - USE ONLY TO DRILL !

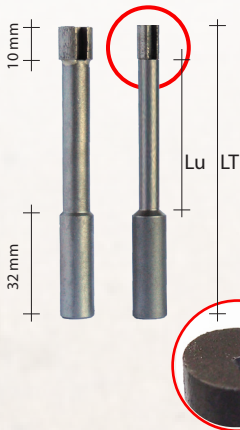

CODE	SIZE	RPM	FEED
ATS0210A	Ø4 LT65 Lu25	6200	25-30 mm/min
ATS0410A	Ø5 LT65 Lu25	6000	30-35 mm/min
ATS0511B	Ø6 LT85 Lu45		
ATS0612C	Ø6.5 LT85 Lu45		
ATS0712B	Ø7 LT85 Lu45		
ATS0814C	Ø8 LT85 Lu45		
ATS1014C	Ø10 LT85 Lu45	5800	25-30 mm/min
ATS1215C	Ø12 LT85 Lu45	5600	
ATS1515C	Ø15 LT85 Lu45	5500	20-25 mm/min



other shanks available upon request !
for No Coring Drill Bits with 1/2 GAS fitting see page C10

NO-CORING BITS HOLDER

Can also be used for T31



CODE	FITTING
AZT0572B	1/2 Gas > Bore 10 *
AZT0572A	1/2 Gas > Bore 12 *
AZT0614A	ADAPTER D12 ** > Bore 8
AZT0614B	ADAPTER D12 ** > Bore 6
AZT0614C	ADAPTER D12 ** > Bore 5
AZT0591A	M14 FEM > Bore 10
AZT0591B	M14 FEM > Bore 12



other sizes could be available on request

☺ = ADVISED

CNC BLADES

cut and drill



CNC SAW BLADES
Segmented

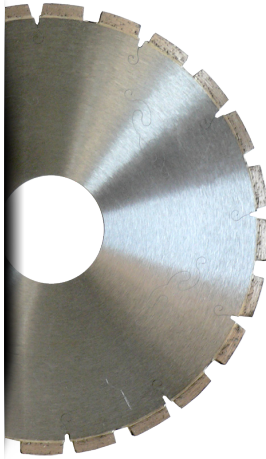

CODE	MAT.	SIZE - Bore	CORE	MACHINE	RPM	FEED
ADS00043	MR	Ø200 - B30+3	Normal	Breton		
D200NEY130640B	GR	Ø200 - B22.2	Normal	Bavelloni		
ADS01011	MR	Ø210 - B50	Silent		2700-3200	
ADS00015	GR	Ø210 - B50	Silent	CMS, Speed, Maxima, Compact		
ADS00017	GR	Ø210 - B50+6H	Silent			
D250LMV301044O	GR	Ø250 - B50	Silent		2400-2700	
D500LF16007556	MR	Ø500 - B50+8HØ7/121	Silent	CMS Maxima	1700	
D500LMV6010506	GR	Ø500 - B50+8HØ7/121	Silent		1400	1200-1500 mm/min
ADS00028	GR	Ø210 - B30+4HØ7/60	Silent		2400-2800	
ADS00030	GR	Ø200 - B30+4HØ7/60	Silent	Breton	2400-2800	
D250LMV301044R	GR	Ø250 - B50+6HØ7/95	Silent		2400-2700	
D250NMV301044i	GR	Ø250 - B30+4HØ9/60	Normal	Intermac	2200-2500	
ADS00002	GR	Ø200 - B50+6H	Normal	Denver	2400-2800	
EDS00014	GR	Ø305 - B60	Normal	Prussiani	2200-2600	
ADS00024	MR	Ø210 - B60	Silent			
ADS00006	GR	Ø200 - B28+3H	Silent	Ravelli	2700-3200	
D300LEY210636R	GR	Ø300 - B35+3H	Silent			
D500NF2360760A	MR	Ø500 - B60+GMM	Normal			
D500NKT301055A	GR	Ø500 - B60+GMM	Normal	Horizontal Cut for GMM		
D500NF2360760V	MR	Ø500 - B120+GMM	Normal	Normal Core 4mm		
D500NKT301055V	GR	Ø500 - B120+GMM	Normal			
CDF520LK2 ^{new}	CR	Ø200 - B50	Normal	for Ceramics		

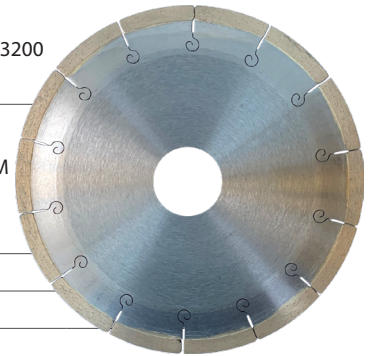

CDF520LK2

* also available with Breton and Intermac hole pattern

CNC CONCAVE SAW BLADES

Concave for Curvilinear Cut



CODE	SIZE	DEG	MACHINE	FEED
CDS51501	Ø150 - B22.2		Bavelloni	
ADS10011	Ø160 - B50+4HØ6/63	30°		
ADS10010	Ø180 - B50+4HØ6/63	30°	CMS 30° Gear Box	
ADS10013	Ø180 - B50+4HØ6/63 Reinforced	30°		
ADS10015	Ø180 - B32+BT	30°	Breton 30° Gear Box	2500-2800 mm/min
ADS10012	Ø180 - B30+4HØ8,5/60	15°		
ADS10011	Ø160 - B50+4HØ6/63	30°	Prussiani 30° Gear Box	
ADS10010	Ø180 - B50+4HØ6/63	30°		
DDS3412S	Ø200 - B30+4HØ8,5/60	15°	INTERMAC	



CNC CONCAVE SAW BLADE + Adapter for various machines

Concave for Curvilinear Cut



DSS46136

CODE	DESCRIPTION
AZT4176B	ADAPTER FOR SPRINT (and others, see below) SX L1117 / D50+4F M6/25
AZT6273B	ADAPTER FOR GIXA A60 L97 / D50+6F M6/63
DSS46136	Concave Blade Ø180-60° - bore 50+6/63



(rear view)

for other blades see on section D

AZT4176B (Sprint, Venkon, Kosmos, Formax, Impact)
AZT6273B (Gixa)

☺ = ADVISED



COREBITS for CERAMICS

Thin Wall
F=1/2Gas



CODE	Ø x Lu/LT	RPM	FEED
APF11011CER	Ø11 (7/16") x 55/95 mm		
APF11015CER	Ø15 (19/32") x 55/95 mm	2500-3000	50-100 mm/min
APF11016CER	Ø16 (5/8") x 55/95 mm		
APF11022CER	Ø22 (55/64") x 55/95 mm	2600	
APF11035CER	Ø35 (1-3/8") x 55/95 mm	2200	40-50 mm/min

ALL DIAMETERS available !



LILAC FB23 FINGERBIT

Segmented - F=1/2Gas

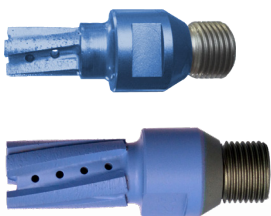

CODE	SIZE	RPM	FEED
AFS90091 ☺	Ø16 x 20 mm - Z4	4500-5200	250-500 mm/min
AFS90128	Ø20 x 25 mm - Z5	4500-5500	350-500 mm/min
AFS90126	Ø20 x 40 mm - Z5		
AFS90279	Ø23 x 25 mm - Z6 TWIN	4500-5200	250-500 mm/min
AFS9001H ☺	Ø23 x 40 mm - Z5	4500-5200	350-550 mm/min
AFS90272	Ø23 x 40 mm - Z6 TWIN	4500-5200	350-600 mm/min



Ø20 CROWN MILLS

SEGMENTED for Incremental Cutting and Flush Fit minimum radius 10 mm

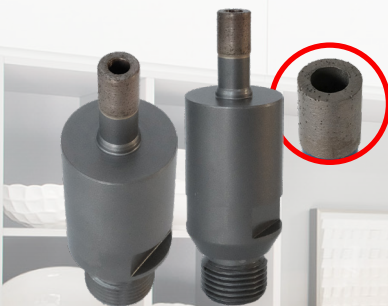

CODE	SIZE	FITTING	MATERIAL	RPM	FEED
CFS40031CER	Ø10 x 10 mm	1/2 GAS	CERAMICS		
CFS40032CER	Ø12 x 10 mm	1/2 GAS	CERAMICS	4800-5500	400 - 100 mm/min 18 - 40 inches/min
CFS4C078	Ø20 x 10 mm	M12	CERAMICS		x 3mm deep
CFS40073CER	Ø20 x 12 mm	1/2 GAS	CERAMICS		



STUBBING WHEELS

Segmented



CODE	SIZE	FITTING	RPM	FEED
AMS00163	Ø50 x 20 mm	B10 - 2+2B	4500-5000	250-500 mm/min. 10-20 inches/min.
AMS00173	Ø50 x 20 mm	B14 - 3+3B		
AMS00159	Ø88 x 20 mm	B50 - 3+3B	4300-4500	400-600 mm/min 16-24 inches/min



TOOLS for CERAMICS

cut, drill & profile



NO CORING DRILL BITS - 10mm Shank
Segmented - USE ONLY TO DRILL !

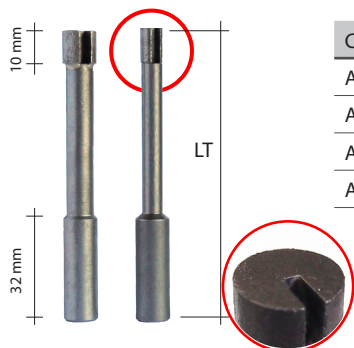

CODE	SIZE	LT	RPM	FEED
ATS0511D	Ø6	85	6000	30-35 mm/min.
ATS08134	Ø8	85	5800	25-30 mm/min.
ATS10144	Ø10	85		
ATS1215D	Ø12	85	5600	20-25 mm/min.

other shanks available upon request

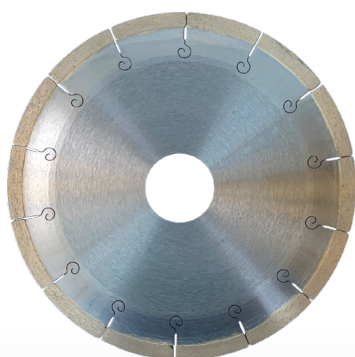

CDF520LK2

Ø 200 DEKTON BLADE for Ceramics
Normal core

CODE	MAT.	SIZE	CORE	MACHINE	RPM	FEED
CDF520LK2 *	CR	Ø200 - B50	Normal			
CDF520LK3	CR	Ø200 - B30+4B	Normal	Intermac		

* also available with Breton

Note:
CDF520LK2 bore 50mm
CDF520LK3 bore 30mm + 4 bores



CODE	Ø mm	Z	CORE	BORE*	BOND	RPM	FEED
D300Si1210830P	Ø300 - 12"	21	SDW	B60	DEK67 G	2000-2200	
D300Ni1210830P ☺	Ø300 - 12"	21	NOR	B60	DEK67 G		
D350Si1250830P	Ø350 - 14"	25	SDW	B60	DEK67 G	1800-1900	300-400 mm/min.
D350Ni1250830P ☺	Ø350 - 14"	25	NOR	B60	DEK67 G		
D400Si1280832P	Ø400 - 16"	28	SDW	B60	DEK67 G	1500-1600	
D400Ni1280832P ☺	Ø400 - 16"	28	NOR	B60	DEK67 G		

* Also available with Bore=50mm - Others Bores available upon request
FOR BIGGER BLADES & OTHER TYPES PLEASE SEE PAGE D4



☺ = ADVISED

Wheels for CERAMICS

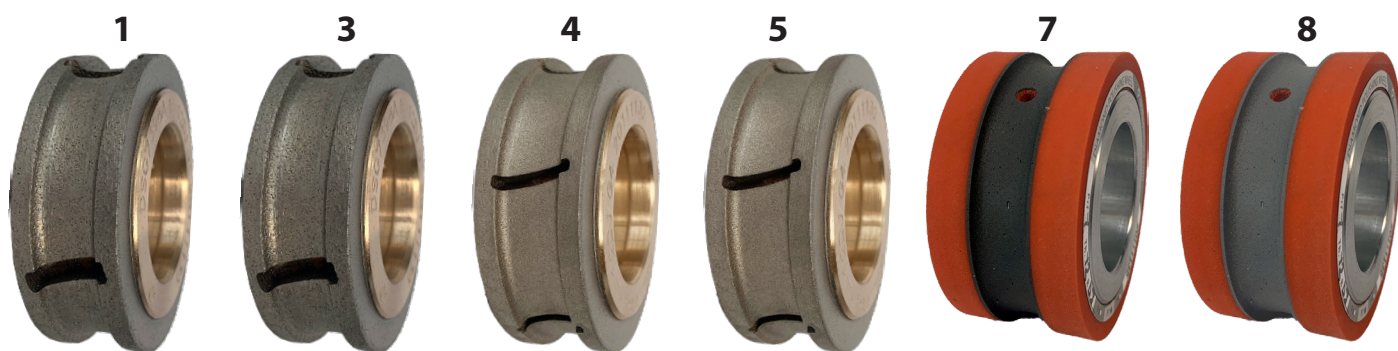

Dm20 & Dm60 Wheels
available for profiles:



PROFILE	Thickness	Metallic Sequence	Polishing Sequence
A / 1 / ZS / 4 / T	4 - 6 - 8 - 10 - 12 - 20 mm	1 - 3 - 5	7 - 8
V	10 - 12 - 20	1 - 3 - 4 - 5	7 - 8

other profiles available upon request

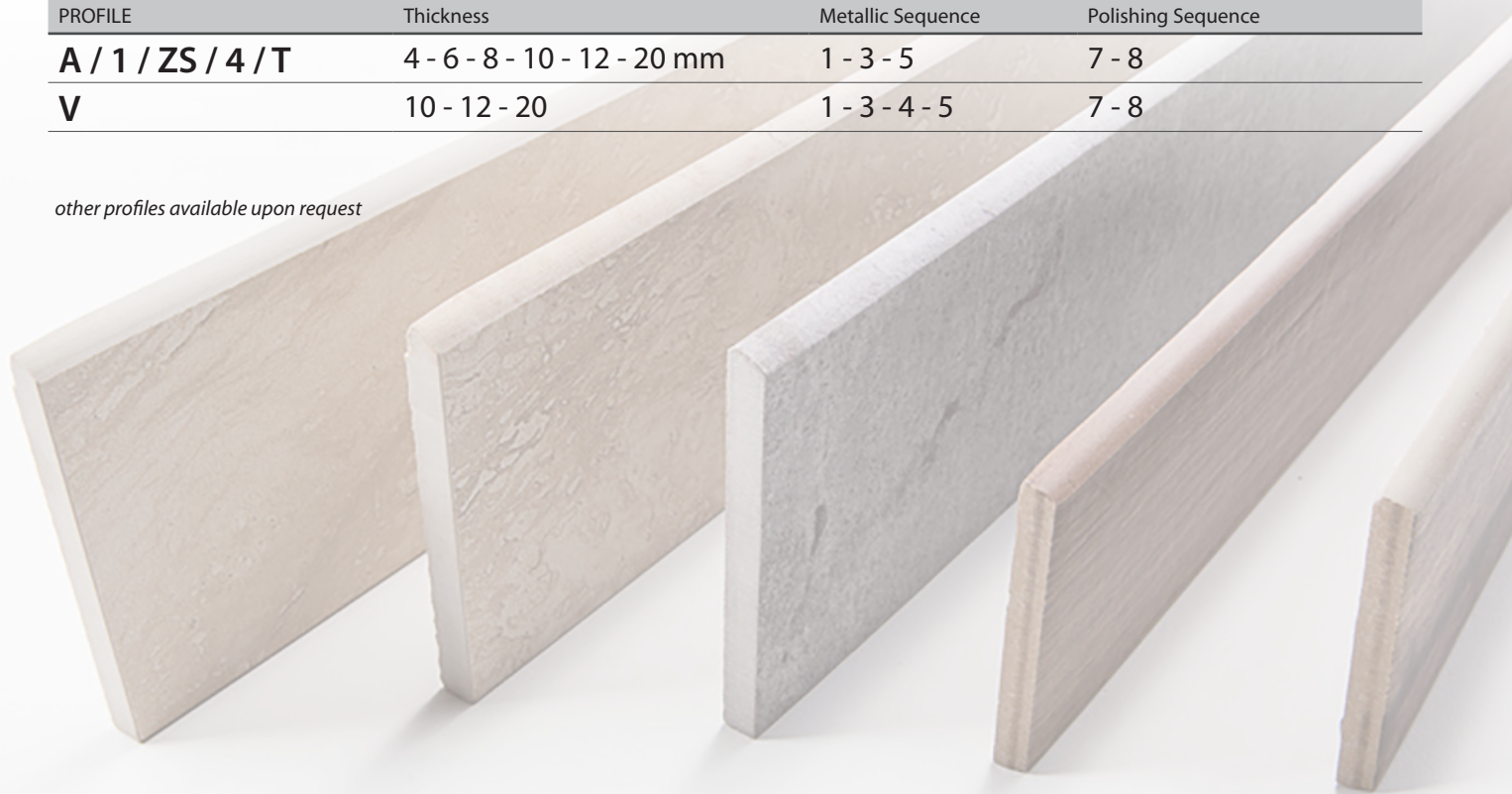



CNC Wheels

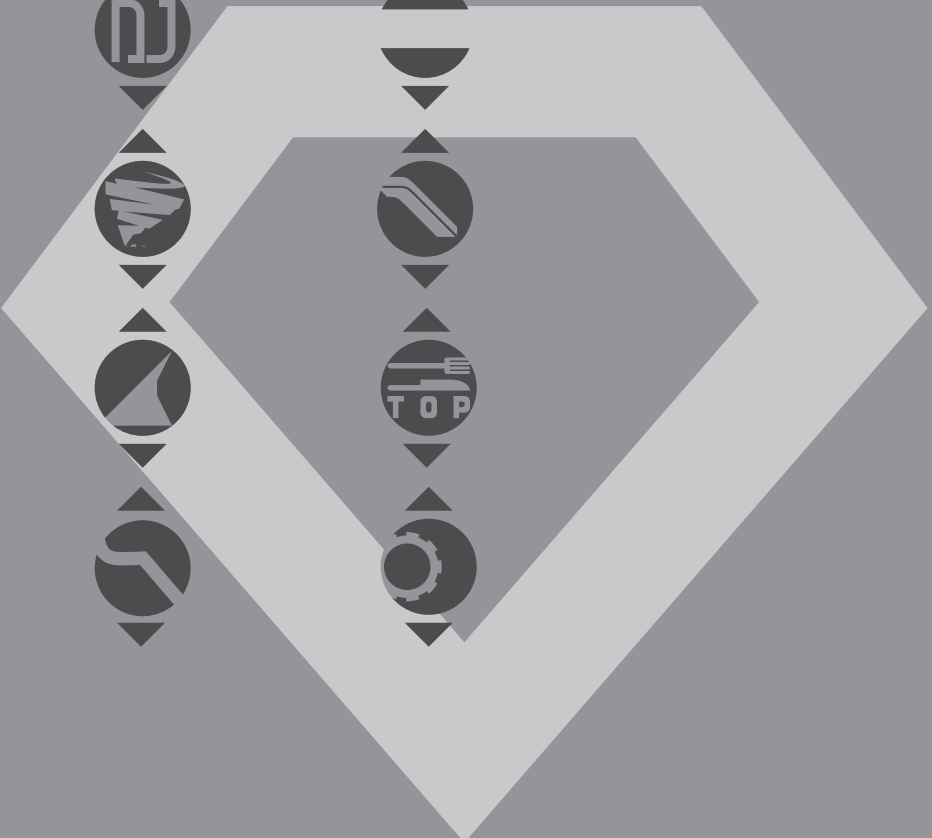



High quality tools for the best value

- 5 sizes Available (XL, L, M, S, XS)
- Standard set of tools configured with seven steps (also available with 5 or 6 steps)
- EVO™ SUPERFAST high speed technology
- JoyLite™ Polishing technology
- The widest selection of Shapes available on the market - Always updated with custom profiles

SERIES	DIMENSIONS	RADIUS	STANDARD FITTING	ON REQUEST FITTING
60 SERIES	60 mm SD (small diameter)	30 mm	35 mm	45 mm, 22 mm
40 SERIES	40 mm SD (small diameter)	20 mm	20 mm	22 mm
20 SERIES	20 mm SD (small diameter)	10 mm	1/2 gas male thread	
10 SERIES	10 mm SD (small diameter)	5 mm	1/2 gas male thread	

Redressing Service: All metal wheels are made with 4,5mm thick of bond and are suitable to be redressed 2 or 3 times for extended life

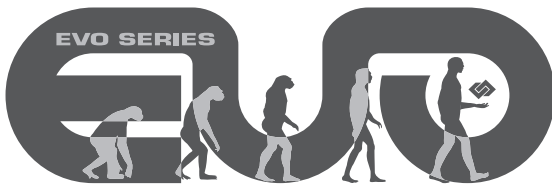

EVO™ Evolutionary bond for high speed & longer life
 Nicolai High Speed Bond for higher feed rate, 3 - 4 times faster than standard metal wheels Nicolai tools generate lower decibels than other high speed tools



Segmented type
 The best solution for profile shaping. Fast and precise.



Continuous with slots
 EDM machined water channels for coolant and waste removal.



Continuous
 Designed for a very smooth finish without water channels
 Water holes for coolant delivery are directly on the diamond surface.



JoyLite™
 JoyLite resin wheels have received worldwide recognition for creating the highest gloss possible
 Rectified resin bond on rectified rubber body with aluminium center. Reinforced thickness for a extra long life.





HOW TO MEASURE OPEN PROFILES

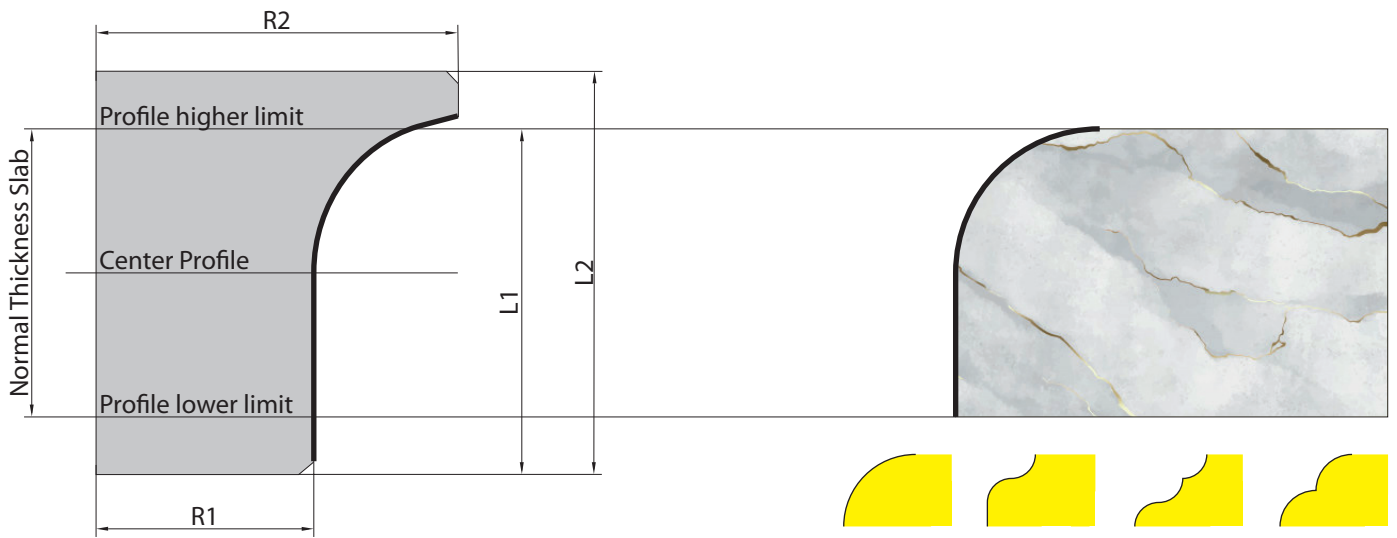

HOW TO MEASURE CLOSED PROFILES

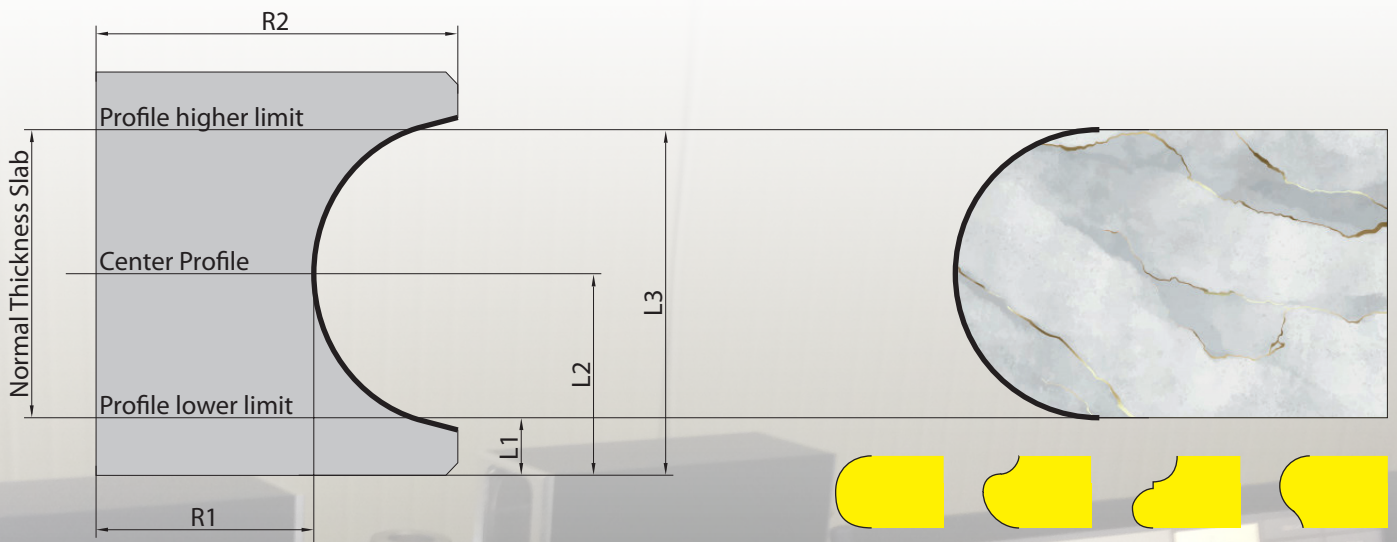



Set 5 + 2 (recommended) 5 metal + 2 rubber polishing wheels

Best Set !

5

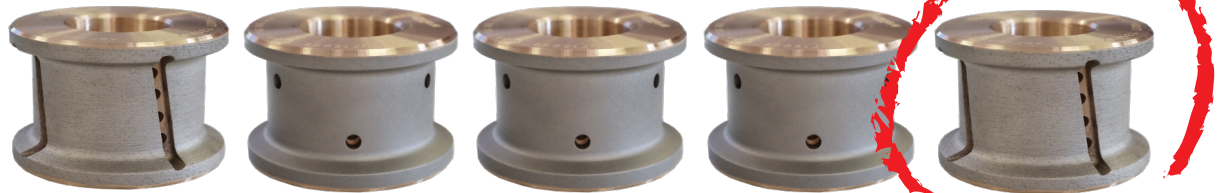

G1f G3 G4 G5 G6f

RPM	5500	5500	5500	5000	5000
REMOVAL (mm)	0.35	0.25	0.15	0.1 max	0.00-0.05 max
FEED (mm/min.)	3000	3500	2500	1200	800-1000
LIFE (before retrue)	1200-1500	1200-1500	1200-1500	1200-1500	2000
LIFE (m)	3600	4500	4500	4500	4500

LONGER LIFE TO THE WHOLE SET WITH G6F WHEEL !

+

2



G7 G8

RPM	3000	3000
REMOVAL (mm)	0.05	0.05
FEED (mm/min.)	1200	1200
LIFE (before retrue)	-	-
LIFE (m)	500	500

Available for all the shapes but specially recommended for

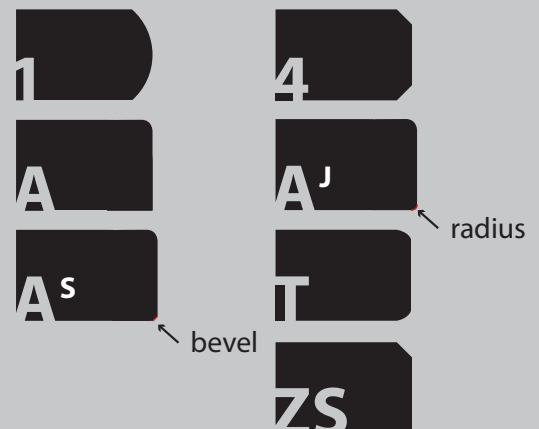

Please Notice:

1. All the REMOVAL parameters have to be taken as a guide line and not as a goal: the less removal you have with getting all your shape and previous diamond line, the better will be for your tool life.
2. Depending on Shop overmaterial left from the saw the Super Z can go faster (i.e.: 2-2.1mm)
3. You can use the Nicolai wheels even with "special" materials like quartzite, dektion, lapitek... but the RPM should be dropped in the 3500-4500 zone and FEED should be dropped in the 30-50% zone.



Set 4 + 3 (classical)

4 metal + 3 rubber polishing wheels

4



G1s

G3

G4

G5

RPM	5500	5500	5500	5000
REMOVAL (mm)	-	0.25	0.15	0.1 max
FEED (mm/min.)	3000	3500	2500	1200
LIFE (before retrue)	1200-1500	1200-1500	1200-1500	1200-1500
LIFE (m)	3600	4500	4500	4500

+

3



G6

G7

G8

RPM	3000	3000	3000
REMOVAL (mm)	0.05	0.05	0.05
FEED (mm/min.)	1200	1200	1200
LIFE (before retrue)	-	-	-
LIFE (m)	500	500	500

Please Notice:

1. All the REMOVAL parameters have to be taken as a guide line and not as a goal: the less removal you have with getting all your shape and previous diamond line, the better will be for your tool life.
2. Depending on Shop overmaterial left from the saw the Super Z can go faster (i.e.: 2-2.1mm)
3. You can use the Nicolai wheels even with "special" materials like quarzite, dektion, lapitek... but the RPM should be dropped in the 3500-4500 zone and FEED should be dropped in the 30-50% zone.



Dressing of the tooling

What sticks for which positions?

GR220 (G3, G4)
GR320 (G3, G4, G5, G6)
GR600 (G5, G6, G7, G8)

Keep dressing sticks in a bucket of water next to the machine, when dressing set the machine spindle to 1000 rpms and dress lightly until full shape and all diamond surfaces are smooth (or as close as you can get it).

DM60-80 tools should be dressed every 500 linear feet or 1-2 times a week if run everyday (1 shift).

DM20 sink tools should be dressed 2-3 times a week if on one shift. Double if run during 2-3 shifts and or, after being used on extremely hard material.

EDM of tooling

DM60-80 tools should be sent in for EDM every 5,000-7,000 linear feet (for optimum life).

DM20 tools can be EDM'd but some customers push them till they are consumed dressing regularly along the way.

Every tool set will be different, the tooling ran more frequently will tend to burn out faster. It all depends on a few things; tooling is there to profile, not hog off a ton of material, so set up is key. The lighter the better. It is or should be the responsibility of the CNC operator to keep an eye on the tooling and watch out for heavy lines that they cannot dress out with the dressing sticks, that means it's time to EDM the tools.

Note: Not every shop is the same, some shops run all quartz or various types of granite, extra hard, hard, soft, medium or some shops run everything engineered stone, granite, quartzite. Quartzite eats and usually consumes the tooling, although these materials are completely manageable if the time is taken to step cut with the segmented G1.

RPM and Federate

High speeds in the CNC industry are desired by some fabricators depending on their business model and capabilities. Nicolai tools are proven to work very efficiently at high speeds and produce quality polish. Certain factors need to be considered though when preparing for this direction. The amount of water outflow from the machine, increased maintenance of tools (dressing, EDM), and ware/depreciation of spindle and machine.

The trend in the market and what is most common is normal feeds and speeds. Not rushing and pushing the machines to their highest capabilities comes with its redundancies. It is more tailored towards quality control and consistency instead of production throughput.



Recommended Parameters

Breakers and or Super Z:

Breakers: 4500 to 6000 rpm @ 50 to 60 IPM

Super Z: 5000 to 6000 @ 60 to 80 IPM

Calibration wheel: 5000 to 6000 rpm @ 30 to 50 IPM

Removal rates DM20-DM120 (inches)

G1: .010 - .012" (to profile)

G3: .006 - .008"

G4: .002 - .004"

G5-G8: 0 - .000"



METAL & RESIN (120mm diameter)

Wheels

TYPE	RPM	FEED (mm/min.)	FEED (inch/min.)
Seg. G1	4500 - 5500	900 - 1600	35-65
Cont. G3	5000 - 5500	2000 - 3700	80-150
Cont. G4	5000 - 5500	2000 - 3700	80-150
Cont. G5	5000 - 5500	1200	50
Cont. G6F	4200	750 - 1000	30-40
Resin G6	3000	1000	40
Resin G7	3000	1000	40
Resin G8	3000	1000	40



METAL & RESIN (80-60mm diameter)

Wheels

TYPE	RPM	FEED (mm/min.)	FEED (inch/min.)
Seg. G1	5000 - 5500	1000 - 2000	40-80
Cont. G3	5000 - 6000	2000 - 3700	80-150
Cont. G4	5000 - 6000	2000 - 3700	80-150
Cont. G5	5000 - 5500	1200 - 1500	50-60
Cont. G6F	4200	750 - 900	30-35
Resin G6	2800	1000	40-60
Resin G7	2800	1000	40-60
Resin G8	2800	1000	40-60



METAL & RESIN (40mm diameter)

Wheels

TYPE	RPM	FEED (mm/min.)	FEED (inch/min.)
Seg. G1	5000 - 6000	1000 - 1500	40-60
Cont. G3	5000 - 6000	1250 - 2500	50-100
Cont. G4	5000 - 6000	1250 - 2500	50-100
Cont. G5	5000 - 5500	1250 - 1500	50-60
Cont. G6F	4200	750 - 900	30-35
Resin G6	2800	1000	50
Resin G7	2800	1000	50
Resin G8	2800	1000	50



METAL & RESIN (20mm diameter)

Wheels

TYPE	RPM	FEED (mm/min.)	FEED (inch/min.)
Seg. G1	6000 - 6500	750-900	30-35
Cont. G3	6000 - 6500	750-900	30-35
Cont. G4	6000 - 6500	750-900	30-35
Cont. G5	6000 - 6500	650-900	25-35
Cont. G6F	6000 - 6500	650-900	25-35
Resin G6	2500	650-900	20-30
Resin G7	2500	650-900	20-30
Resin G8	2500	650-900	20-30

Please Notice:

1. All the REMOVAL parameters have to be taken as a guide line and not as a goal: the less removal you have with getting all your shape and previous diamond line, the better will be for your tool life.
2. You can use the Nicolai wheels even with "special" materials like quartzite, dektion, lapitek... but the RPM should be dropped in the 3500-4500 zone and FEED should be dropped in the 30-50% zone.

Hi-Speed Parameters

It's not a bad idea to run the tools for 100meters (330 linear feet) first to get them worn in for the high speeds. If using super z at these speeds you can expect .5mm of wear per 400-500 linear meters. This should be accounted for when programming and progressing through tool life.

Super Z: 120" per min / removal to shape

G1: 355" per min / .008" removal rate

G3: 510" per min / .006"

G4: 510" per min / .004"

G5: 100" per min / .002"

G6 (metal): 60" per min / .001"

G7: 70" per min / 0

G8: 70" per min / 0

RPM

5500 for all metals except last metal

Last metal 5000 rpm

2700 for polisher

Material REMOVAL RATES OF #G1, #G3, #G4, #G5, #G6F

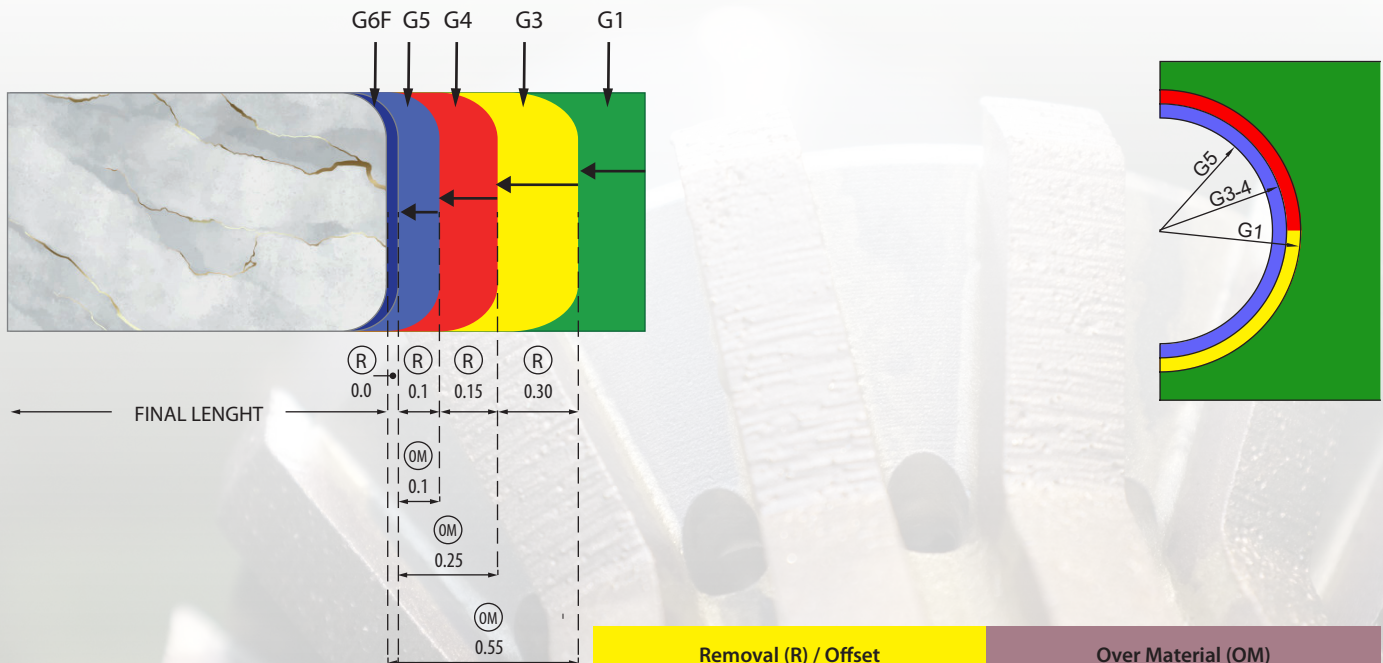
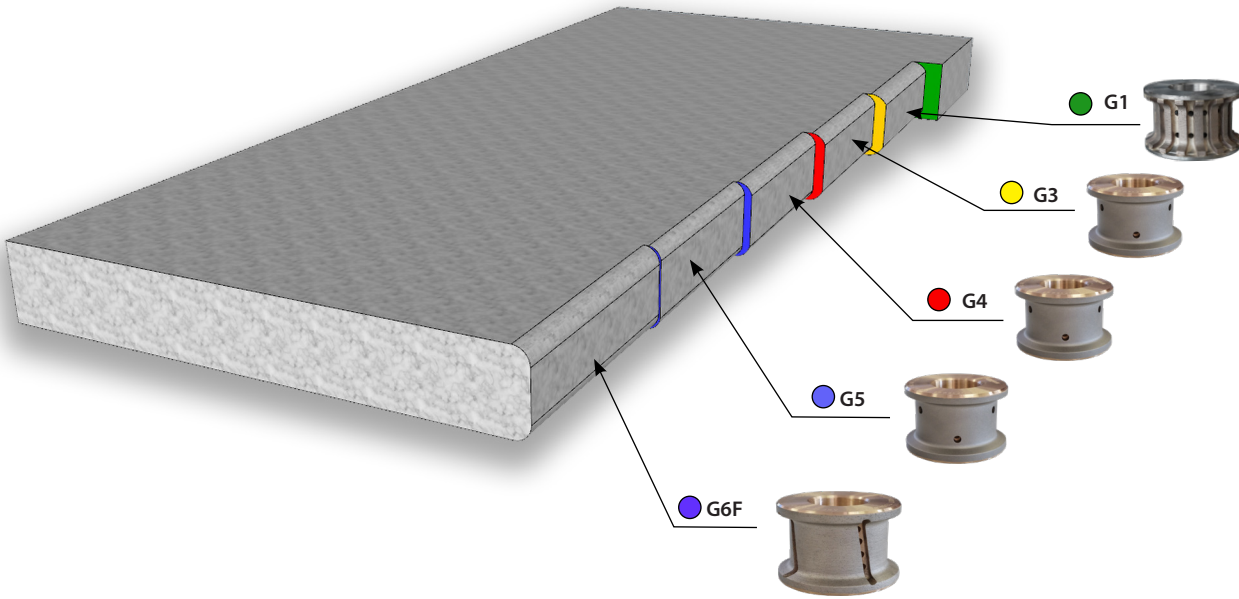

Offsets & Pressures of #G6, #G7, #G8

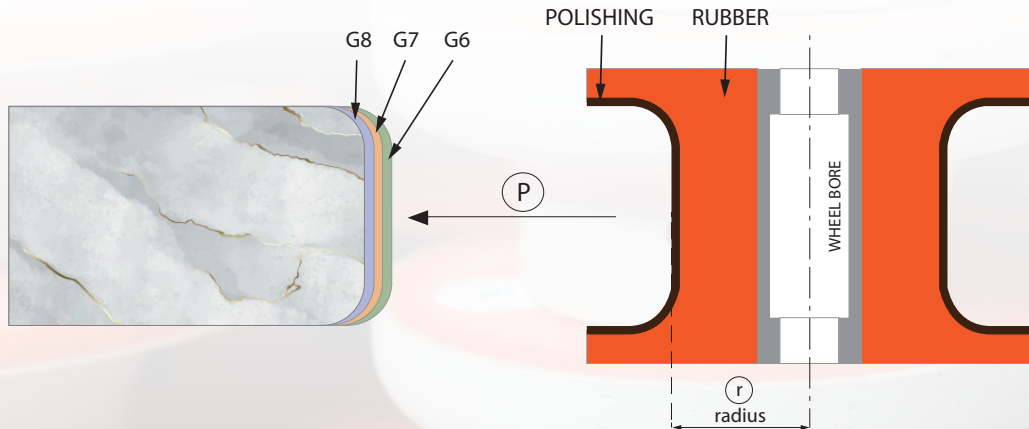
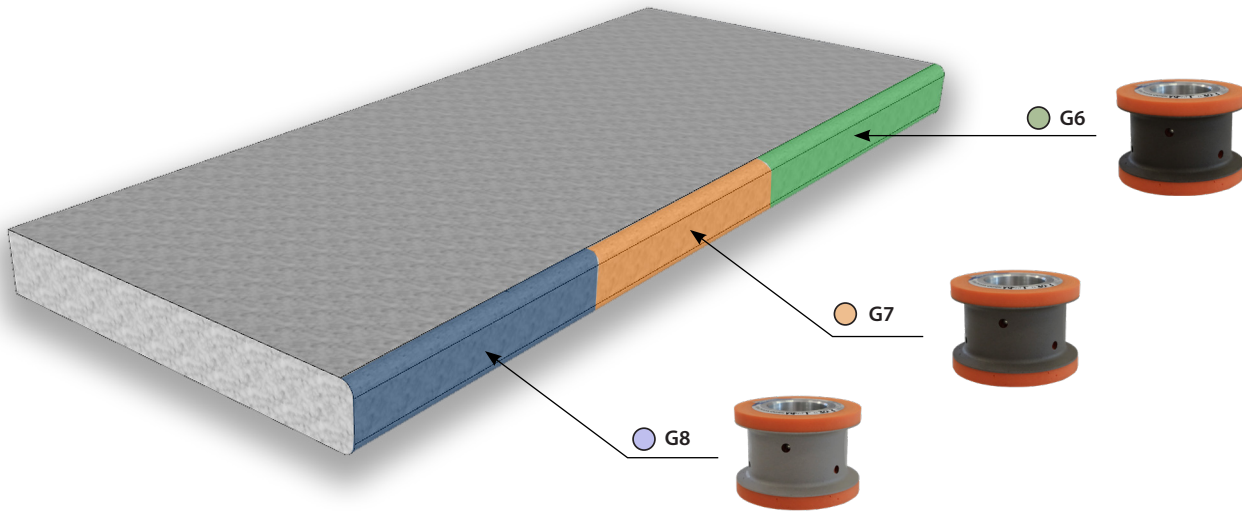

$$P = r - R \text{ (Removal/offset)}$$

Pressure = radius of the wheel - Removal (see table below)

STEP	TYPE	GRIT	Removal (R) / Offset		Over Material (OM)	
			from - to (mm)	from - to (inches)	from - to (mm)	from - to (inches)
Step 5	Joylite	G6	0.000 - 0.000	0.000" - 0.000"	0.000 - 0.000	0.000" - 0.000"
Step 6	Joylite	G7	0.000 - 0.000	0.000" - 0.000"	0.000 - 0.000	0.000" - 0.000"
Step 7	Joylite	G8	0.000 - 0.000	0.000" - 0.000"	0.000 - 0.000	0.000" - 0.000"



A20 R = 10
A30 R = 15
A40 R = 20

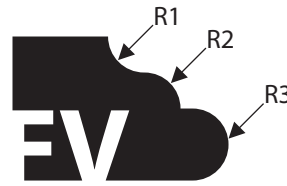

FV30 R1=7.5 R1=7.5 R1=7.5
FV40 R1=9.65 R1=7.97 R1=9.65
FV50 R1=15 R1=15 R1=11



B20 R = 20
B30 R = 30
B40 R = 40



FZ30 R = 10 L = 10
FZ40 R = 10 L = 20



D20 R = 5.2 $\alpha = 30^\circ$
D30 R = 7.5 $\alpha = 30^\circ$
D40 R = 11.4 $\alpha = 33^\circ$
ask for more options

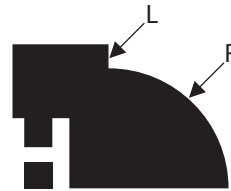

H20 R = 15 L = 5
H30 R = 25 L = 5
H40 R = 30 L = 10

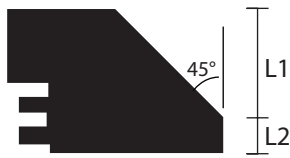

E20 L1 = 15 L2 = 5
E30 L1 = 20 L2 = 10
E40 L1 = 20 L2 = 20
ask for more options

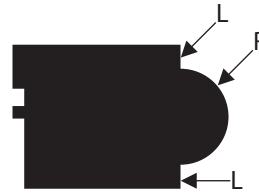

i20 R = 5 L = 6
i30 R = 5 L = 12

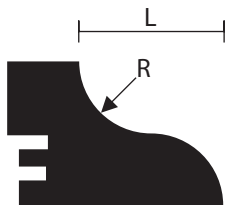

F20 R = 10 L = 20
F30 R = 15 L = 30
F40 R = 20 L = 40

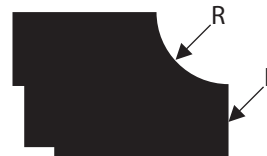

L20 R = 10 L = 10
L30 R = 15 L = 15

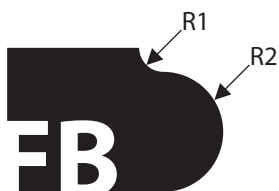

FB30 R = 8 L = 12
FB40 R = 12 L = 16

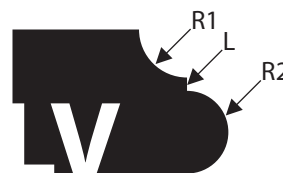

LV30 R1 = 18 R2 = 10 L = 2.5
LV40 R1 = 24 R2 = 12 L = 6



FG30 R1 = 7.5 R2 = 15
FG40 R1 = 9.5 R2 = 19



M20 R1 = 14 R2 = 6
M30 R1 = 18 R2 = 11
M40 R1 = 25 R2 = 12

STANDARD PROFILES

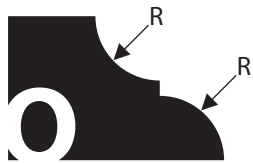

O20 R = 8 L = 4
O30 R = 12.5 L = 5
O40 R = 17 L = 6



ZS20 7x7 L1 = 2→5 L2 = 20 - L1
ZS30 7x7 L1 = 2→5 L2 = 30 - L1
ZS40 7x7 L1 = 2→5 L2 = 40 - L1
ZS30 10x10 L1 = 10 L2 = 20
ZS40 10x10 L1 = 10 L2 = 30



O20 R1 = 20 R2 = 6
O30 R1 = 30 R2 = 9



1-30 R = 23
1-40 R = 25

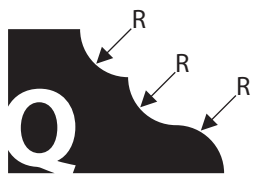

Q20 R = 6.5
Q30 R = 10
Q40 R = 13

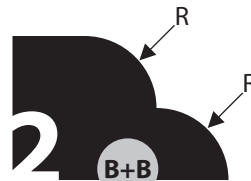

2-30 R = 15



T20 R = 3
T30 R = 3 or 5
T40 R = 5
ask for more options

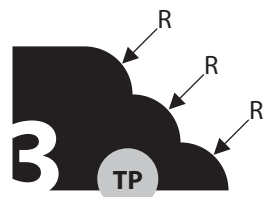

3-20 R = 6.5
3-30 R = 10
3-40 R = 12.5



V20 R = 10
V30 R = 15
V40 R = 20

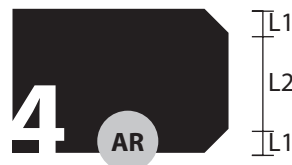

4-20 L1 = 2.5 L2 = 15
4-30 L1 = 2.5 L2 = 25
4-40 L1 = 2.5 L2 = 35
ask for more options



Z20 R = 20
Z30 R = 30
Z40 R = 40

other profiles could be available on request



ZR20 R = 5
ZR30 R = 5
ZR40 R = 6

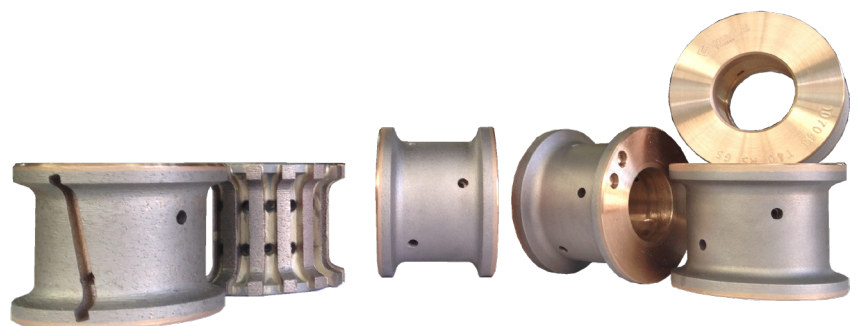

J SERIES PROFILES

profiling



Single 2mm chamfer

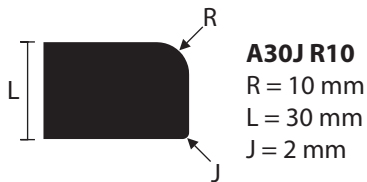
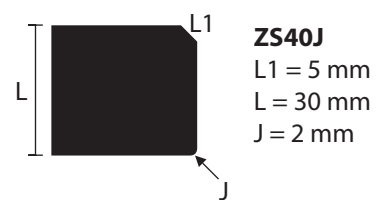
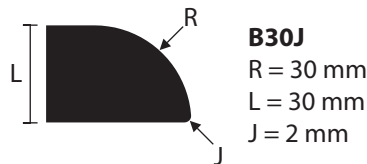
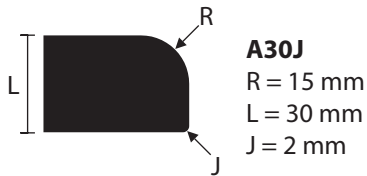
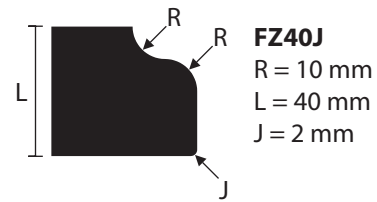
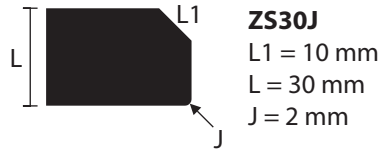
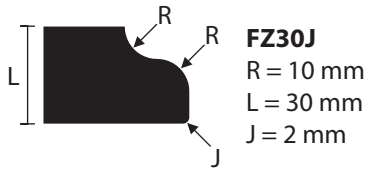

See tools on page A28-a

DJ SERIES PROFILES

profiling



Double 2mm chamfer, up and bottom

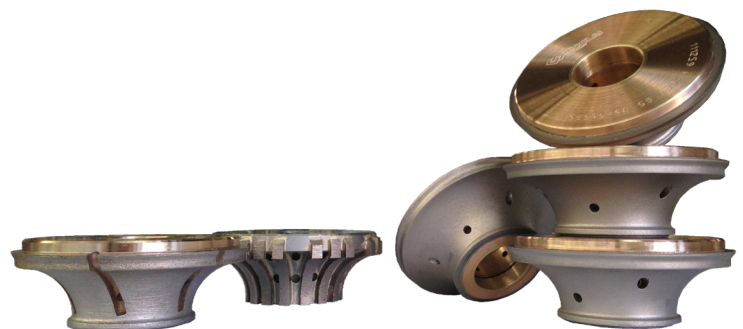
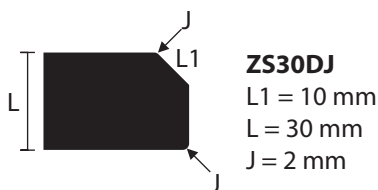
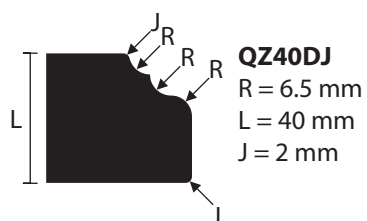
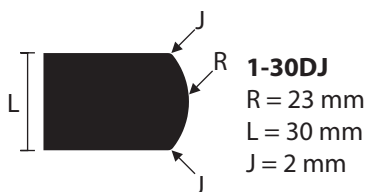
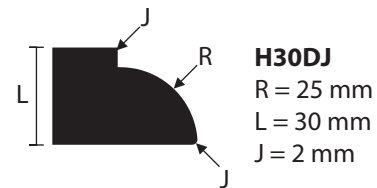
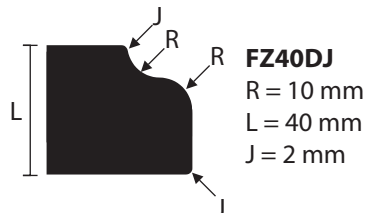
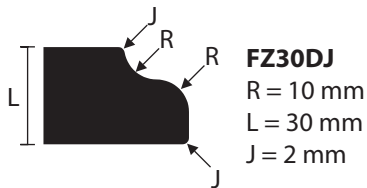

See tools on page A28-b

PRE-SHAPING WHEELS - TORNADO

profiling

TORNADO CORNER BREAKER - PROFILE Y
 Segmented - Ultra High Speed Stock Removal

CODE	DESCRIPTION	TYPE / POSITION	RPM	FEED
DSS0940S	Y30 - MB7	Segmented / P0	4800 - 5000	1200 - 2000 mm/min
DSS0940C	Y30 - MB5	Segmented / P0		
DSS2711Y	Y40 - MB8	Segmented / P0		

Min Ø 65 mm / Max Ø 126 mm

TORNADO CORNER BREAKER - PROFILE X
 Segmented - Ultra High Speed Stock Removal

CODE	DESCRIPTION	TYPE / POSITION	RPM	FEED
DSS1937S	X40 - MB9	Segmented / G1	4800 - 5000	1200 - 2000 mm/min
on request	X30 - MB7	Segmented / G1		

Min Ø 65 mm / Max Ø 92 mm



PRE-SHAPING WHEELS

profiling

PRE-SHAPING WHEEL - PROFILE Y
 Segmented - Ultra High Speed Stock Removal

CODE	DESCRIPTION	TYPE / POSITION	RPM	FEED
ASS00045	Y40	Segmented / P0	4500	500 - 700 mm/min
ASS00040	Y30	Segmented / P0		

Min Ø 60 mm / Max Ø 146 mm



PRE-SHAPING WHEEL - PROFILE x
 Segmented - Ultra High Speed Stock Removal

CODE	DESCRIPTION	TYPE / POSITION	RPM	FEED
ASS00015	X40	Segmented / P0	4500	500 - 700 mm/min
ASS00010	X30	Segmented / P0		

Min Ø 60 mm / Max Ø 90 mm

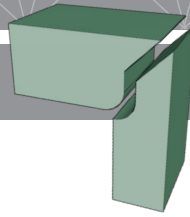

MITRE SYSTEM



profiling



MITRE - MALE WHEEL

Max Ø 120 mm

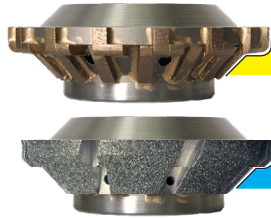

STEP	CODE	TYPE	SLAB	RPM	FEED
1	DSS3897S	Segmented G1	20 mm	4300 - 4800	600 - 1000 mm/min
2	DSE3897C	Electroplated D1	20 mm		
1	DSS4227S	Segmented G1	30 mm	4300 - 4800	600 - 1000 mm/min
2	DSE4227C	Electroplated D1	30 mm		

For MARBLE you can use only the Electroplated wheel



MITRE - FEMALE WHEEL

Max Ø 120 mm



STEP	CODE	TYPE	SLAB	RPM	FEED
1	DSS3898S	Segmented G1	20 mm	4300 - 4800	600 - 1000 mm/min
2	DSE3898C	Electroplated D1	20 mm		
1	DSS4228S	Segmented G1	30 mm	4300 - 4800	600 - 1000 mm/min
2	DSE4228C	Electroplated D1	30 mm		

For MARBLE you can use only the Electroplated wheel

45° MITRE SYSTEM

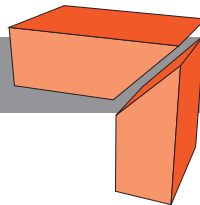

profiling



PRE-SHAPING WHEEL - TORNADO

Segmented - Min Ø60 / Max Ø 146 mm



STEP	CODE	TYPE	SLAB	RPM	FEED
0	DSS0940C	Multiblade	30 mm	4800- 5000	1200-2000 mm/min

Advisable the use of a Tornado before the cornerbreaker step 1 - 2



PRE-SHAPING WHEEL

Segmented - Min Ø60 / Max Ø 146 mm



STEP	CODE	TYPE	SLAB	RPM	FEED
2	ASS00040	Segmented G1	30 mm	4500	500 - 700 mm/min

For MARBLE you can use the Electroplated wheel D1 (DSE0940C)

PRE-SHAPING WHEEL

Electroplated - Min Ø60 / Max Ø 146 mm

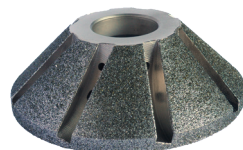

STEP	CODE	TYPE	SLAB	RPM	FEED
3	DSE0940H	Electroplated D2	30 mm	4500	800-1000 mm/min

For MARBLE you can use also the coarser grit DSE0940C

OVERSIZE WHEELS



100/120mm OD*
Extra large diameter, 120 mm Outside Diameter

Features:

- 120 mm OD*
- 35 mm bore (22 mm & 45 mm upon request)
- EVO High Speed Technology
- To be used with JoyLite JoyLite resin 60mm diamond polishing Wheel

*OD = outside diameter

METAL BOND
Metal Body Wheels

		STANDARD Parameters				
		TYPE	RPM	FEED (mm/min.)	FEED (inch/min.)	DISTANCE
Step 1		Segmented G1	4500 - 5500	900 - 1600	35-65	to profile
Step 2		Continuous G3	5000 - 5500	2000 - 3700	80-150	0.30 mm 0.012"
Step 3		Continuous G4	5000 - 5500	2000 - 3700	80-150	0.15 mm 0.006"
Step 4		Continuous G5	5000 - 5500	1200	50	0.10 mm 0.004"
Opt. 5		Continuous G6F	4200	750 - 1000	30-40	0.00 mm



* Advisable the use of a cornerbreaker before the profiling set of wheels

RESIN BOND diameter 60mm
Rubber Body Wheels

		JoyLite Parameters				
		TYPE	RPM	FEED (mm/min)	FEED (inch/min)	DISTANCE
Step 5		Resin G6	3000	1000	40	0 - 0.00 mm 0 - 0.00"
Step 6		Resin G7	3000	1000	40	0 - 0.00 mm 0 - 0.00"
Step 7		Resin G8	3000	1000	40	0 - 0.00 mm 0 - 0.00"

Note:
EVO Wheels can be used at standard operating parameters to yield longer tool life.

EVO parameters should only be used with machine capable of such settings. Using these settings with lower grade machinery can result in major damage to your machine and to the tools themselves.



STEP	TYPE	CODE A30 r15
1	Segmented G1	ASS60105
2	Continuous G3	ASF60120
3	Continuous G4	ASF60125
4	Continuous G5	ASF60130
5	JoyLite™ G6	CSLA3099935606
6	JoyLite™ G7	CSLA3099935607
7	JoyLite™ G8	CSLA3099935608

Min Ø 80 mm / Max Ø 120 mm / JoyLite™ wheels are Ø60



STEP	TYPE	CODE B30 r30
1	Segmented G1	
2	Continuous G3	
3	Continuous G4	
4	Continuous G5	
5	JoyLite™ G6	CSLB3099935606
6	JoyLite™ G7	CSLB3099935607
7	JoyLite™ G8	CSLB3099935608

Min Ø 80 mm / Max Ø 125 mm / JoyLite™ wheels are Ø60



STEP	TYPE	CODE FZ40
1	Segmented G1	ASS60005
2	Continuous G3	ASF60020
3	Continuous G4	ASF60025
4	Continuous G5	ASF60030
5	JoyLite™ G6	CSLF2020935606
6	JoyLite™ G7	CSLF2020935607
7	JoyLite™ G8	CSLF2020935608

Min Ø 80 mm / Max Ø 120 mm / JoyLite™ wheels are Ø60

OVERSIZE WHEELS

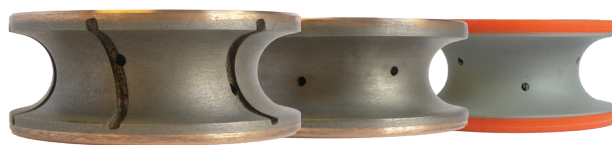
profiling **XL**

STEP	TYPE	CODE V30 r15
1	Segmented G1	ASS63105
2	Continuous G3	ASF63120
3	Continuous G4	ASF63125
4	Continuous G5	ASF63130
5	JoyLite™ G6	CSLV3099935606
6	JoyLite™ G7	CSLV3099935607
7	JoyLite™ G8	CSLV3099935608

Min Ø 80 mm / Max Ø 120 mm / JoyLite™ wheels are Ø60

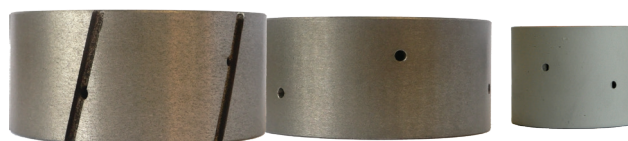

STEP	TYPE	CODE Z h35 Ø80	CODE Z h35 Ø100	BEST SET
1	Segmented G1	ASSK4505	ASSQ4505	
1F	Continuous G1F*	ASFK4513	ASFQ4513	✓
2	Continuous G3	ASFK4520	ASFQ4520	✓
3	Continuous G4	ASFK4525	ASFQ4525	
4	Continuous G5	ASFK4530	ASFQ4530	✓
4F	Continuous G6F*	ASFK4535	ASFQ4535	✓
5	JoyLite™ G6	CSLZ3599935606	CSLZ3599935606	
6	JoyLite™ G7	CSLZ3599935607	CSLZ3599935607	✓
7	JoyLite™ G8	CSLZ3599935608	CSLZ3599935608	✓

*To be use in alternative of the Segmented G1 / JoyLite™ wheels

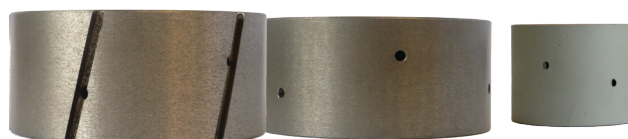

STEP	TYPE	CODE Z h45 Ø80	CODE Z h45 Ø100	BEST SET
1	Segmented G1	ASSK4605	ASSQ4605	
1F	Continuous G1F*	ASFK4613	ASFQ4613	✓
2	Continuous G3	ASFK4620	ASFQ4620	✓
3	Continuous G4	ASFK4625	ASFQ4625	
4	Continuous G5	ASFK4630	ASFQ4630	✓
4F	Continuous G6F*	ASFK4635	ASFQ4635	✓
5	JoyLite™ G6	CSLZ4599935606	CSLZ4599935606	
6	JoyLite™ G7	CSLZ4599935607	CSLZ4599935607	✓
7	JoyLite™ G8	CSLZ4599935608	CSLZ4599935608	✓

*To be use in alternative of the Segmented G1 / JoyLite™ wheels



SEGMENTED PACKED WHEEL
From h 85 mm To h 200 mm

COARSE



SEGMENTED WHEEL
From h 25 mm To h 110 mm

COARSE



CONTINUOUS PACKED WHEEL
From h 85 mm To h 200 mm

MEDIUM / FINE



CONTINUOUS WHEEL
From h 25 mm To h 110 mm

MEDIUM / FINE



ELECTROPLATED WHEEL
From h 25 mm To h 200 mm

COARSE / MEDIUM / FINE

*available diameters
Ø 60 / 80 / 100 mm*



JoyLite WHEEL
From h 25 mm To h 160 mm

POLISHING



ORIGAMI WHEEL
From h 65 mm To h 200 mm

POLISHING

bore on request



60mm SD*

Large diameter, the external dimensions change according to the profile while smaller diameter remains always the same, SD* 60 mm (radius 30mm)





Features

- 60 mm SD*
- 35 mm bore (22 mm & 45 mm upon request)
- EVO Technology
- Matching with JoyLite JoyLite resin diamond polishing wheels with rubber body

*SD = smaller diameter

METAL BOND

Metal Body Wheels

STANDARD Parameters					
	TYPE	RPM	FEED (mm/min.)	FEED (inch/min.)	DISTANCE
Step 1 ▶	 Segmented G1	5000 - 5500	1000 - 2000	40-80	to profile
Step 2 ▶	 Continuous G3	5000 - 6000	2000 - 3700	80-150	0.30 mm 0.012"
Step 3 ▶	 Continuous G4	5000 - 6000	2000 - 3700	80-150	0.15 mm 0.006"
Step 4 ▶	 Continuous G5	5000 - 5500	1200 - 1500	50-60	0.10 mm 0.004"
Opt. 5 ▶	 Continuous G6F	4200	750 - 900	30-35	0.00 mm



* Advisable the use of a cornerbreaker before the profiling set of wheels

RESIN BOND diameter 60mm

Rubber Body Wheels

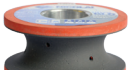
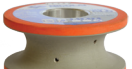
JoyLite Parameters					
	TYPE	RPM	FEED (mm/min)	FEED (inch/min)	DISTANCE
Step 5 ▶	 Resin G6	2800	1000	40-60	0 - 0.00 mm 0 - 0.00"
Step 6 ▶	 Resin G7	2800	1000	40-60	0 - 0.00 mm 0 - 0.00"
Step 7 ▶	 Resin G8	2800	1000	40-60	0 - 0.00 mm 0 - 0.00"

Note:

EVO Wheels can be used at standard operating parameters to yield longer tool life.

EVO parameters should only be used with machine capable of such settings. Using these settings with lower grade machinery can result in major damage to your machine and to the tools themselves.



STEP	TYPE	CODE A20	CODE A30	CODE A40
1	Segmented G1	ASS10005	ASS10105	ASS10205
2	Continuous G3	ASF10020	ASF10120	ASF10220
3	Continuous G4	ASF10025	ASF10125	ASF10225
4	Continuous G5	ASF10030	ASF10130	ASF10230
5	JoyLite™ G6	CSLA2099935606	CSLA3099935606	CSLA4099935606
6	JoyLite™ G7	CSLA2099935607	CSLA3099935607	CSLA4099935607
7	JoyLite™ G8	CSLA2099935608	CSLA3099935608	CSLA4099935608

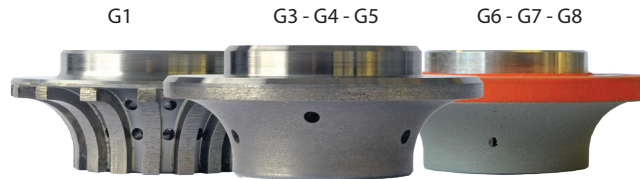

STEP	TYPE	CODE B20	CODE B30	CODE B40
1	Segmented G1	ASS10305	ASS10405	ASS10505
2	Continuous G3	ASF10320	ASF10420	ASF10520
3	Continuous G4	ASF10325	ASF10425	ASF10525
4	Continuous G5	ASF10330	ASF10430	ASF10530
5	JoyLite™ G6	CSLB2099935606	CSLB3099935606	CSLB4099935606
6	JoyLite™ G7	CSLB2099935607	CSLB3099935607	CSLB4099935607
7	JoyLite™ G8	CSLB2099935608	CSLB3099935608	CSLB4099935608



STEP	TYPE	CODE D20	CODE D30	CODE D40
1	Segmented G1	ASS10605	ASS10705	ASS10805
2	Continuous G3	ASF10620	ASF10720	ASF10820
3	Continuous G4	ASF10625	ASF10725	ASF10825
4	Continuous G5	ASF10630	ASF10730	ASF10830
5	JoyLite™ G6	CSLD2099935606	CSLD3099935606	CSLD4099935606
6	JoyLite™ G7	CSLD2099935607	CSLD3099935607	CSLD4099935607
7	JoyLite™ G8	CSLD2099935608	CSLD3099935608	CSLD4099935608

DM60 WHEELS

profiling **60**

G1

G3 - G4 - G5

G6 - G7 - G8

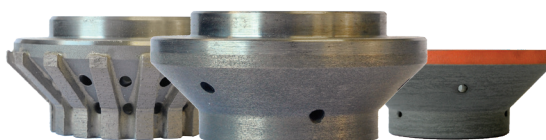

STEP	TYPE	CODE E20	CODE E30	CODE E40
1	Segmented G1	ASS10905	ASS11005	ASS11105
2	Continuous G3	ASF10920	ASF11020	ASF11120
3	Continuous G4	ASF10925	ASF11025	ASF11125
4	Continuous G5	ASF10930	ASF11030	ASF11130
5	JoyLite™ G6	CSLE2099935606	CSLE3099935606	CSLE4099935606
6	JoyLite™ G7	CSLE2099935607	CSLE3099935607	CSLE4099935607
7	JoyLite™ G8	CSLE2099935608	CSLE3099935608	CSLE4099935608



G1

G3 - G4 - G5

G6 - G7 - G8

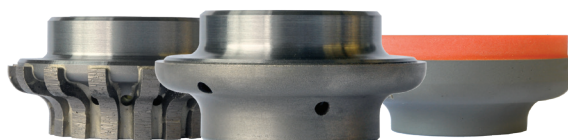

STEP	TYPE	CODE F20	CODE F30	CODE F40
1	Segmented G1	ASS11205	ASS11305	ASS11405
2	Continuous G3	ASF11220	ASF11320	ASF11420
3	Continuous G4	ASF11225	ASF11325	ASF11425
4	Continuous G5	ASF11230	ASF11330	ASF11430
5	JoyLite™ G6	CSLF2099935606	CSLF3099935606	CSLF4099935606
6	JoyLite™ G7	CSLF2099935607	CSLF3099935607	CSLF4099935607
7	JoyLite™ G8	CSLF2099935608	CSLF3099935608	CSLF4099935608



G1

G3 - G4 - G5

G6 - G7 - G8

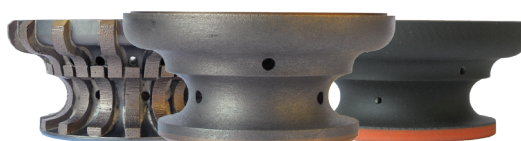

STEP	TYPE	CODE FV30	CODE FV40	CODE FV50
1	Segmented G1	DSS19485	DSS19545	DSS21155
2	Continuous G3	DSG19483	DSG19543	DSG21153
3	Continuous G4	DSG19484	DSG19544	DSG21154
4	Continuous G5	DSG19485	DSG19545	DSG21155
5	JoyLite™ G6	CSLF15V1535606	CSLF20V2035606	
6	JoyLite™ G7	CSLF15V1535607	CSLF20V2035607	
7	JoyLite™ G8	CSLF15V1535608	CSLF20V2035608	

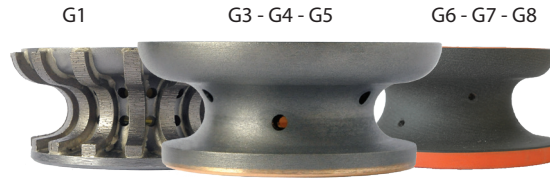

STEP	TYPE	CODE FB30	CODE FB40
1	Segmented G1	DSS3906S	DSS2465S
2	Continuous G3	DSG39063	DSG24653
3	Continuous G4	DSG39064	DSG24654
4	Continuous G5	DSG39065	DSG24655
5	JoyLite™ G6	CSL530S4935606	CSL540S4935606
6	JoyLite™ G7	CSL530S4935607	CSL540S4935607
7	JoyLite™ G8	CSL530S4935608	CSL540S4935608

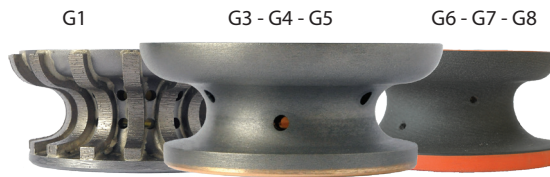

STEP	TYPE	CODE FG30	CODE FG40
1	Segmented G1	DSS3831S	DSS2236S
2	Continuous G3	DSG38313	DSG22363
3	Continuous G4	DSG38314	DSG22364
4	Continuous G5	DSG38315	DSG22365
5	JoyLite™ G6	CSLFG309935606	CSLFG409935606
6	JoyLite™ G7	CSLFG309935607	CSLFG409935607
7	JoyLite™ G8	CSLFG309935608	CSLFG409935608

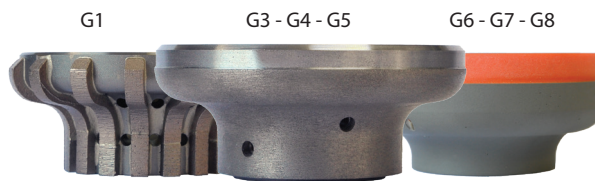

STEP	TYPE	CODE FZ30	CODE FZ40
1	Segmented G1	DSS0507S	ASS1870S
2	Continuous G3	DSG05073	ASF18720
3	Continuous G4	DSG05074	ASF18725
4	Continuous G5	DSG05075	ASF18730
5	JoyLite™ G6	CSLF2010935606	CSLF2020935606
6	JoyLite™ G7	CSLF2010935607	CSLF2020935607
7	JoyLite™ G8	CSLF2010935608	CSLF2020935608

DM60 WHEELS

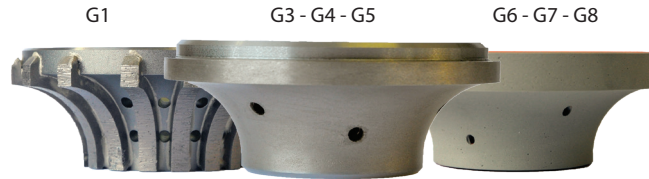
profiling **60**

STEP	TYPE	CODE H20	CODE H30	CODE H40
1	Segmented G1	ASS11505	ASS11605	ASS11705
2	Continuous G3	ASF11520	ASF11620	ASF11720
3	Continuous G4	ASF11525	ASF11625	ASF11725
4	Continuous G5	ASF11530	ASF11630	ASF11730
5	JoyLite™ G6	CSLH2099935606	CSLH3099935606	CSLH4099935606
6	JoyLite™ G7	CSLH2099935607	CSLH3099935607	CSLH4099935607
7	JoyLite™ G8	CSLH2099935608	CSLH3099935608	CSLH4099935608

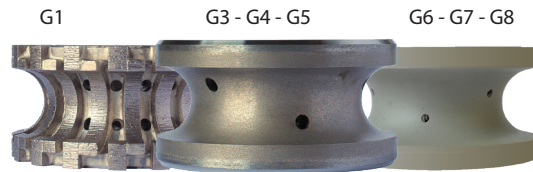

STEP	TYPE	CODE i20	CODE i30
1	Segmented G1	ASS14805	ASS14905
2	Continuous G3	ASF14820	ASF14920
3	Continuous G4	ASF14825	ASF14925
4	Continuous G5	ASF14830	ASF14930
5	JoyLite™ G6		
6	JoyLite™ G7		
7	JoyLite™ G8		

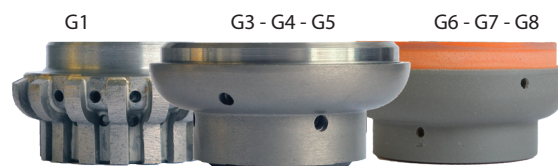

STEP	TYPE	CODE L2 0	CODE L30	CODE L40
1	Segmented G1	ASS11805	ASS11905	ASS12005
2	Continuous G3	ASF11820	ASF11920	ASF12020
3	Continuous G4	ASF11825	ASF11925	ASF12025
4	Continuous G5	ASF11830	ASF11930	ASF12030
5	JoyLite™ G6	CSLL2099935606	CSLL3099935606	
6	JoyLite™ G7	CSLL2099935607	CSLL3099935607	
7	JoyLite™ G8	CSLL2099935608	CSLL3099935608	

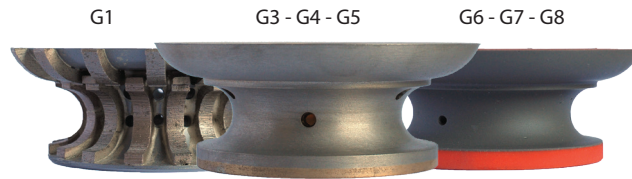

STEP	TYPE	CODE LV30	CODE LV40
1	Segmented G1	DSS10865	DSS30225
2	Continuous G3	DSG10863	DSG30223
3	Continuous G4	DSG10864	DSG30224
4	Continuous G5	DSG10865	DSG30225
5	JoyLite™ G6	CSLL15V1535606	CSLL20V2035606
6	JoyLite™ G7	CSLL15V1535607	CSLL20V2035607
7	JoyLite™ G8	CSLL15V1535608	CSLL20V2035608

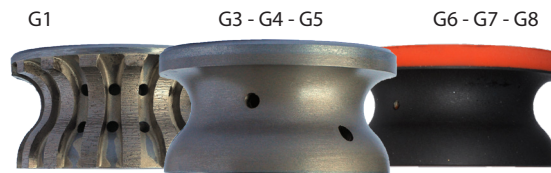

STEP	TYPE	CODE M20	CODE M30	CODE M40
1	Segmented G1	ASS12105	ASS12205	ASS12305
2	Continuous G3	ASF12120	ASF12220	ASF12320
3	Continuous G4	ASF12125	ASF12225	ASF12325
4	Continuous G5	ASF12130	ASF12230	ASF12330
5	JoyLite™ G6		CSLM3099935606	CSLM4099935606
6	JoyLite™ G7		CSLM3099935607	CSLM4099935607
7	JoyLite™ G8		CSLM3099935608	CSLM4099935608

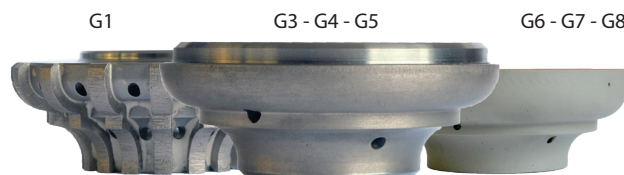

STEP	TYPE	CODE O20	CODE O30	CODE O40
1	Segmented G1	ASS12405	ASS12505	ASS12605
2	Continuous G3	ASF12420	ASF12520	ASF12620
3	Continuous G4	ASF12425	ASF12525	ASF12625
4	Continuous G5	ASF12430	ASF12530	ASF12630
5	JoyLite™ G6	CSLO2099935606	CSLO3099935606	CSLO4099935606
6	JoyLite™ G7	CSLO2099935607	CSLO3099935607	CSLO4099935607
7	JoyLite™ G8	CSLO2099935608	CSLO3099935608	CSLO4099935608

DM60 WHEELS

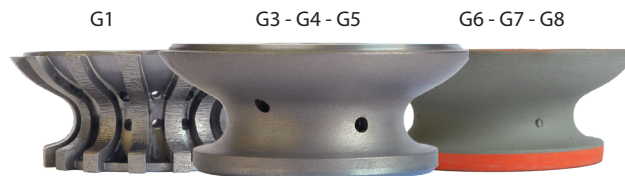
profiling **60****OG**

STEP	TYPE	CODE OG20	CODE OG30
1	Segmented G1	DSS3352S	DSS3272S
2	Continuous G3	DSG33523	DSG32723
3	Continuous G4	DSG33524	DSG32724
4	Continuous G5	DSG33525	DSG32725
5	JoyLite™ G6	CSLOG209935606	CSLOG309935606
6	JoyLite™ G7	CSLOG209935607	CSLOG309935607
7	JoyLite™ G8	CSLOG209935608	CSLOG309935608

Q

STEP	TYPE	CODE Q20	CODE Q30	CODE Q40
1	Segmented G1	ASS16005	ASS16105	ASS16205
2	Continuous G3	ASF16020	ASF16120	ASF16220
3	Continuous G4	ASF16025	ASF16125	ASF16225
4	Continuous G5	ASF16030	ASF16130	ASF16230
5	JoyLite™ G6	CSLQ2099935606	CSLQ3099935606	CSLQ4099935606
6	JoyLite™ G7	CSLQ2099935607	CSLQ3099935607	CSLQ4099935607
7	JoyLite™ G8	CSLQ2099935608	CSLQ3099935608	CSLQ4099935608

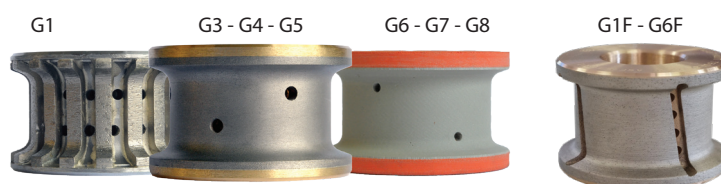
T

STEP	TYPE	CODE T20 r3	CODE T30 r3 (new)	CODE T30 r5	CODE T40 r5	BEST SET
1	Segmented G1	ASS12705		ASS12805	ASS12905	
1F	Continuous G1F *	ASF12713	ASF18313	ASF12813	ASF12913	✓
2	Continuous G3	ASF12720	ASF18320	ASF12820	ASF12920	✓
3	Continuous G4	ASF12725	ASF18325	ASF12825	ASF12925	
4	Continuous G5	ASF12730	ASF18330	ASF12830	ASF12930	✓
4F	Continuous G6F	ASF12735	ASF18335	ASF12835	ASF12935	✓
5	JoyLite™ G6	CSLT20R3935606	CSLT30R3935606	CSLT30R5935606	CSLT40R5935606	
6	JoyLite™ G7	CSLT20R3935607	CSLT30R3935607	CSLT30R5935607	CSLT40R5935607	✓
7	JoyLite™ G8	CSLT20R3935608	CSLT30R3935608	CSLT30R5935608	CSLT40R5935608	✓

*To be use in alternative of the Segmented G1 / JoyLite™ wheels

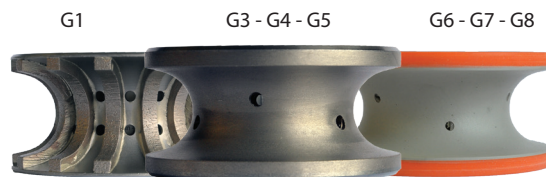

STEP	TYPE	CODE V20	CODE V30	CODE V40
1	Segmented G1	ASS13005	ASS13105	ASS13205
2	Continuous G3	ASF13020	ASF13120	ASF13220
3	Continuous G4	ASF13025	ASF13125	ASF13225
4	Continuous G5	ASF13030	ASF13130	ASF13230
5	JoyLite™ G6	CSLV2099935606	CSLV3099935606	CSLV4099935606
6	JoyLite™ G7	CSLV2099935607	CSLV3099935607	CSLV4099935607
7	JoyLite™ G8	CSLV2099935608	CSLV3099935608	CSLV4099935608

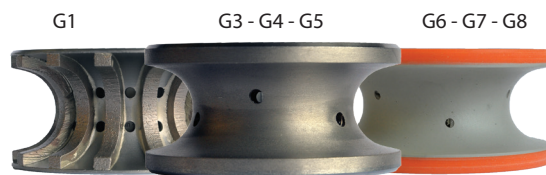

STEP	TYPE	CODE V50	CODE V60	CODE V80
0	Segmented G0		ASS00025	DSS26380
1	Segmented G1	ASS13305	ASS13405	DSS26385
2	Continuous G3	ASF13320	ASF13420	DSS26383 <i>SEG</i>
3	Continuous G4	ASF13325	ASF13425	DSS26384 <i>SEG</i>
4	Continuous G5	ASF13330	ASF13430	DSS26385 <i>SEG</i>
5	JoyLite™ G6	CSLV5099935606	CSLV6099935606	
6	JoyLite™ G7	CSLV5099935607	CSLV6099935607	
7	JoyLite™ G8	CSLV5099935608	CSLV6099935608	

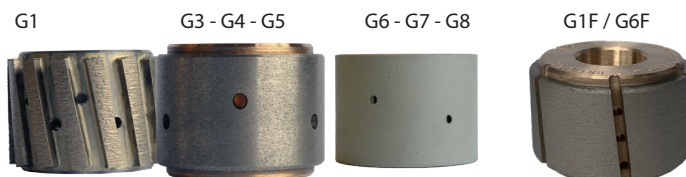

STEP	TYPE	CODE Z35	CODE Z45	CODE Z55	BEST SET
1	Segmented G1	ASS14505	ASS14605	ASS14705	
1F	Continuous G1F *	ASF14513	ASF14613	ASF14713	✓
2	Continuous G3	ASF14520	ASF14620	ASF14720	✓
3	Continuous G4	ASF14525	ASF14625	ASF14725	
4	Continuous G5	ASF14530	ASF14630	ASF14730	✓
4F	Continuous G6F *	ASF14535	ASF14635	ASF14735	✓
5	JoyLite™ G6	CSLZ3599935606	CSLZ4599935606	CSLZ5599935606	
6	JoyLite™ G7	CSLZ3599935607	CSLZ4599935607	CSLZ5599935607	✓
7	JoyLite™ G8	CSLZ3599935608	CSLZ4599935608	CSLZ5599935608	✓

*To be use in alternative of the Segmented G1 / JoyLite™ wheels

DM60 WHEELS

profiling **60****ZR**

STEP	TYPE	CODE ZR20 r5	CODE ZR30 r5	CODE ZR40 r6
1	Segmented G1	ASS19405	ASS17005	ASS17805
2	Continuous G3	ASF19420	ASF17020	ASF17820
3	Continuous G4	ASF19425	ASF17025	ASF17825
4	Continuous G5	ASF19430	ASF17030	ASF17830
5	JoyLite™ G6		CSLA30R5935606	CSLA40R6935606
6	JoyLite™ G7		CSLA30R5935607	CSLA40R6935607
7	JoyLite™ G8		CSLA30R5935608	CSLA40R6935608

ZS

STEP	TYPE	CODE ZS20 (21x7)	CODE ZS30 (31x7)	CODE ZS40 (41x7)	BEST SET
1	Segmented G1	DSS51595	DSS14255	DSS47405	
1F	Continuous G1F *		DSG1425A	DSG4740A	✓
2	Continuous G3	DSG51593	DSG14253	DSG47403	✓
3	Continuous G4	DSG51594	DSG14254	DSG47404	
4	Continuous G5	DSG51595	DSG14255	DSG47405	✓
4F	Continuous G6F *		DSG14256	DSG47406	✓
5	JoyLite™ G6		CSLZS300735606	CSLZS400735606	
6	JoyLite™ G7		CSLZS300735607	CSLZS400735607	✓
7	JoyLite™ G8		CSLZS300735608	CSLZS400735608	✓

*To be use in alternative of the Segmented G1 / JoyLite™ wheels

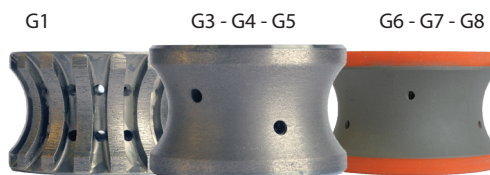
1

STEP	TYPE	CODE 1-30	CODE 1-40
1	Segmented G1	ASS16405	ASS16505
2	Continuous G3	ASF16420	ASF16520
3	Continuous G4	ASF16425	ASF16525
4	Continuous G5	ASF16430	ASF16530
5	JoyLite™ G6	CSL13099935606	CSL14099935606
6	JoyLite™ G7	CSL13099935607	CSL14099935607
7	JoyLite™ G8	CSL13099935608	CSL14099935608



STEP	TYPE	CODE 3-20	CODE 3-30	CODE 3-40
1	Segmented G1	ASS13905	ASS14005	ASS14105
2	Continuous G3	ASF13920	ASF14020	ASF14120
3	Continuous G4	ASF13925	ASF14025	ASF14125
4	Continuous G5	ASF13930	ASF14030	ASF14130
5	JoyLite™ G6	CSL32099935606	CSL33099935606	CSL34099935606
6	JoyLite™ G7	CSL32099935607	CSL33099935607	CSL34099935607
7	JoyLite™ G8	CSL32099935608	CSL33099935608	CSL34099935608



STEP	TYPE	CODE 4-20	CODE 4-30	CODE 4-40	BEST SET
1	Segmented G1	ASS14205	ASS14305	ASS14405	
1F	Continuous G1F *	ASF14213	ASF14313	ASF14413	✓
2	Continuous G3	ASF14220	ASF14320	ASF14420	✓
3	Continuous G4	ASF14225	ASF14325	ASF14425	
4	Continuous G5	ASF14230	ASF14330	ASF14430	✓
6F	Continuous G6F *	ASF14235	ASF14335	ASF14435	✓
5	JoyLite™ G6	CSL42099935606	CSL43099935606	CSL44099935606	
6	JoyLite™ G7	CSL42099935607	CSL43099935607	CSL44099935607	✓
7	JoyLite™ G8	CSL42099935608	CSL43099935608	CSL44099935608	✓

*To be use in alternative of the Segmented G1 / JoyLite™ wheels

custom profiles could be available on request



Single 2mm chamfer

A30J

STEP	TYPE	CODE A30J (R3)	CODE A30J (R5)	CODE A30J (R10)	CODE A30J (R15)
1	Segmented G1	DSS2712S	ASS17005	ASS10B05	ASS10105
2	Continuous G3	DSG66783	DSG69523	DSG47763	DSG47723
3	Continuous G4	DSG66784	DSG69524	DSG47764	DSG47724
4	Continuous G5	DSG66785	DSG69525	DSG47765	DSG47725
5	JoyLite™ G6	CSLA30J3935606 (note*)	CSLA30J1035606 (note*)	CSLA30J1035606 (note*)	CSLA30J9935606 (note*)
6	JoyLite™ G7	CSLA30J3935607 (note*)	CSLA30J1035607 (note*)	CSLA30J1035607 (note*)	CSLA30J9935607 (note*)
7	JoyLite™ G8	CSLA30J3935608 (note*)	CSLA30J1035608 (note*)	CSLA30J1035608 (note*)	CSLA30J9935608 (note*)

B20J

STEP	TYPE	CODE B20J
1	Segmented G1	ASS10305
2	Continuous G3	DSG69043
3	Continuous G4	DSG69044
4	Continuous G5	DSG69045
5	JoyLite™ G6	CSLB20J9935606 (note*)
6	JoyLite™ G7	CSLB20J9935607 (note*)
7	JoyLite™ G8	CSLB20J9935608 (note*)

B30J

STEP	TYPE	CODE B30J
1	Segmented G1	ASS10405
2	Continuous G3	DSG55853
3	Continuous G4	DSG55854
4	Continuous G5	DSG55855
5	JoyLite™ G6	CSLB30J9935606 (note*)
6	JoyLite™ G7	CSLB30J9935607 (note*)
7	JoyLite™ G8	CSLB30J9935608 (note*)

FZ30J

STEP	TYPE	CODE FZ30J
1	Segmented G1	DSS0507S
2	Continuous G3	DSG46663
3	Continuous G4	DSG46664
4	Continuous G5	DSG46665
5	JoyLite™ G6	CSLFZ30J935606 (note*)
6	JoyLite™ G7	CSLFZ30J935607 (note*)
7	JoyLite™ G8	CSLFZ30J935608 (note*)

FZ40J

STEP	TYPE	CODE FZ40J
1	Segmented G1	ASS18705
2	Continuous G3	DSG47823
3	Continuous G4	DSG47824
4	Continuous G5	DSG47825
5	JoyLite™ G6	CSLFZ40J935606 (note*)
6	JoyLite™ G7	CSLFZ40J935607 (note*)
7	JoyLite™ G8	CSLFZ40J935608 (note*)

ZS30J

STEP	TYPE	CODE ZS30J
1	Segmented G1	DSS1496S
2	Continuous G3	DSG54543
3	Continuous G4	DSG54544
4	Continuous G5	DSG54545
5	JoyLite™ G6	CSLZS30J935606 (note*)
6	JoyLite™ G7	CSLZS30J935607 (note*)
7	JoyLite™ G8	CSLZS30J935608 (note*)

ZS40J

STEP	TYPE	CODE ZS40J
1	Segmented G1	DSS4740S
2	Continuous G3	DSG47833
3	Continuous G4	DSG47834
4	Continuous G5	DSG47835
5	JoyLite™ G6	CSLZS40J735606 (note*)
6	JoyLite™ G7	CSLZS40J735607 (note*)
7	JoyLite™ G8	CSLZS40J735608 (note*)

NOTE*: 3pcs minimum order (G6+G7+G8 Joylite wheels) could be requested



Double 2mm chamfer, up and bottom



STEP	TYPE	CODE FZ30DJ
1	Segmented G1	DSS05075
2	Continuous G3	DSG57973
3	Continuous G4	DSG57974
4	Continuous G5	DSG57975
5	JoyLite™ G6	CSLFZ30DJ35606 (note*)
6	JoyLite™ G7	CSLFZ30DJ35607 (note*)
7	JoyLite™ G8	CSLFZ30DJ35608 (note*)



STEP	TYPE	CODE FZ40DJ
1	Segmented G1	DSS5831S
2	Continuous G3	DSG58313
3	Continuous G4	DSG58314
4	Continuous G5	DSG58315
5	JoyLite™ G6	CSLFZ40DJ35606 (note*)
6	JoyLite™ G7	CSLFZ40DJ35607 (note*)
7	JoyLite™ G8	CSLFZ40DJ35608 (note*)



STEP	TYPE	CODE H30DJ
1	Segmented G1	ASS11605
2	Continuous G3	DSG59533
3	Continuous G4	DSG59534
4	Continuous G5	DSG59535
5	JoyLite™ G6	CSLH30DJ935606 (note*)
6	JoyLite™ G7	CSLH30DJ935607 (note*)
7	JoyLite™ G8	CSLH30DJ935608 (note*)



STEP	TYPE	CODE QZ40DJ
1	Segmented G1	DSS5499S
2	Continuous G3	DSG54993
3	Continuous G4	DSG54994
4	Continuous G5	DSG54995
5	LUX Abrasive G6	DSR54992
6	LUX Abrasive G7	DSR54994
7	LUX Abrasive G8	DSR54991



STEP	TYPE	CODE ZS30DJ
1	Segmented G1	DSS1425S
2	Continuous G3	DSG59583
3	Continuous G4	DSG59584
4	Continuous G5	DSG59585
5	JoyLite™ G6	CSLZS30DJ35606 (note*)
6	JoyLite™ G7	CSLZS30DJ35607 (note*)
7	JoyLite™ G8	CSLZS30DJ35608 (note*)



STEP	TYPE	CODE 1-30DJ
1	Segmented G1	ASS1640S
2	Continuous G3	DSG60373
3	Continuous G4	DSG60374
4	Continuous G5	DSG60375
5	JoyLite™ G6	CSL130DJ935606 (note*)
6	JoyLite™ G7	CSL130DJ935607 (note*)
7	JoyLite™ G8	CSL130DJ935608 (note*)

NOTE*: 3pcs minimum order (G6+G7+G8 Joylite wheels) could be requested

ELECTROPLATED DM60 WHEELS FOR MARBLE

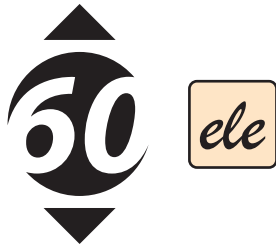

60mm SD Diameter Electroplated for marble & Limestone
 Large diameter, the external dimensions change according to the profile while smaller diameter remains always the same, SD 60 mm (radius 30mm)

Features

- 60 mm SD
- 35 mm bore (22 mm & 45 mm upon request)
- Galvanized diamond plating
- To be used with abrasive polish wheels with plastic core

*SD = smaller diameter

ELECTROPLATED
 Metal Body Wheels

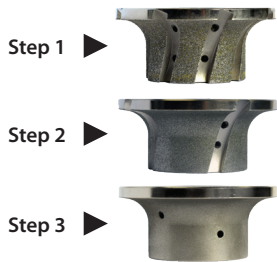

		STANDARD Parameters		
TYPE	RPM	FEED	DISTANCE	
Electrop. D1	4500-5000	1000-1500 mm/min	To Profile	
Electrop. D2	4500-5000	800-1200 mm/min	0.30 mm 0.012"	
Electrop. D3	4500-5000	800-1200 mm/min	0.30 mm 0.012"	



Other grits available:

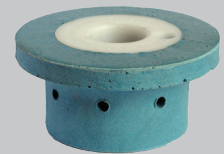

Abrasive 220



Abrasive 600



Abrasive LUX

ABRASIVES
 Plastic Core

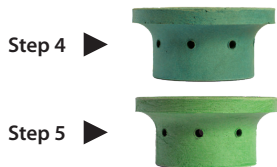

		JoyLite Parameters		
TYPE	RPM	FEED	DISTANCE	
Abrasive 400	1000	600-800 mm/min	0.015 mm 0.0006"	
Abrasive 1000	1000	600-800 mm/min	0.015 mm 0.0006"	



or you can use JoyLite™ like in Granite and ES

Best Performance Kit
 Electropated, Cont. Rim & Joylite



Ele D1



Ele D2



FCC G5
 see page A20-A27
 depending on shape



JoyLite G7
 see page A20-A27
 depending on shape



JoyLite G8
 see page A20-A27
 depending on shape



STEP	TYPE	CODE A20	CODE A30	CODE A40
1	Electroplated G1	ASE10040	ASE10140	ASE10240
2	Electroplated G2	ASE10050	ASE10150	ASE10250
3	Electroplated G3	ASE10060	ASE10158	ASE10260
4	Abrasive G400	ASR50075	ASE10160	ASR50275
5	Abrasive G1000	ASR50080	ASR50175	ASR50280



STEP	TYPE	CODE B20	CODE B30	CODE B40
1	Electroplated G1	ASE10340	ASE10440	ASE10540
2	Electroplated G2	ASE10350	ASE10450	ASE10550
3	Electroplated G3	ASE10360	ASE10460	ASE10560
4	Abrasive G400	ASR50375	ASR50475	ASR50575
5	Abrasive G1000	ASR50380	ASR50480	ASR50580



STEP	TYPE	CODE D20	CODE D30	CODE D40
1	Electroplated G1	ASE10640	ASE10740	ASE10840
2	Electroplated G2	ASE10650	ASE10750	ASE10850
3	Electroplated G3	ASE10660	ASE10760	ASE10860
4	Abrasive G400	ASR50675	ASR50775	ASR50875
5	Abrasive G1000	ASR50680	ASR50780	ASR50880



STEP	TYPE	CODE E20	CODE E30	CODE E40
1	Electroplated G1	ASE10940	ASE11040	ASE11140
2	Electroplated G2	ASE10950	ASE11050	ASE11150
3	Electroplated G3	ASE10960	ASE11060	ASE11160
4	Abrasive G400	ASR50975	ASR51075	ASR51175
5	Abrasive G1000	ASR50980	ASR51080	ASR51180



STEP	TYPE	CODE F20	CODE F30	CODE F40
1	Electroplated G1	ASE11240	ASE11340	ASE11440
2	Electroplated G2	ASE11250	ASE11350	ASE11450
3	Electroplated G3	ASE11260	ASE11360	ASE11460
4	Abrasive G400	ASR51275	ASR51375	ASR51475
5	Abrasive G1000	ASR51280	ASR51380	ASR51480



STEP	TYPE	CODE H20	CODE H30	CODE H40
1	Electroplated G1	ASE11540	ASE11640	ASE11740
2	Electroplated G2	ASE11550	ASE11650	ASE11750
3	Electroplated G3	ASE11560	ASE11660	ASE11760
4	Abrasive G400	ASR51575	ASR51675	ASR51775
5	Abrasive G1000	ASR51578	ASR51680	ASR51780

ELECTROPLATED DM60 WHEELS FOR MARBLE

profiling **60**

STEP	TYPE	CODE I20	CODE I30	CODE I40
1	Electroplated G1	ASE14840	ASE14940	
2	Electroplated G2	ASE14850	ASE14950	ASE15050
3	Electroplated G3	ASE14860	ASE14960	ASE15060
4	Abrasive G400	ASR54875	ASR54975	ASR55075
5	Abrasive G1000	ASR54880	ASR54980	ASR55080



STEP	TYPE	CODE L20	CODE L30	CODE L40
1	Electroplated G1	ASE11840	ASE11940	ASE12040
2	Electroplated G2	ASE11850	ASE11950	ASE12050
3	Electroplated G3	ASE11860	ASE11960	ASE12060
4	Abrasive G400	ASR51875	ASR51975	ASR52075
5	Abrasive G1000	ASR51880	ASR51980	ASR52080



STEP	TYPE	CODE M20	CODE M30	CODE M40
1	Electroplated G1	ASE12140	ASE12240	ASE12340
2	Electroplated G2	ASE12150	ASE12250	ASE12350
3	Electroplated G3	ASE12160	ASE12260	ASE12360
4	Abrasive G400	ASR52175	ASR52275	ASR52375
5	Abrasive G1000	ASR52180	ASR52280	ASR52380



STEP	TYPE	CODE O20	CODE O30	CODE O40
1	Electroplated G1	ASE12440	ASE12540	ASE12640
2	Electroplated G2	ASE12450	ASE12550	ASE12650
3	Electroplated G3	ASE12460	ASE12560	ASE12660
4	Abrasive G400	ASR52475	ASR52575	ASR52675
5	Abrasive G1000	ASR52480	ASR52580	ASR52680



STEP	TYPE	CODE Q20	CODE Q30	CODE Q40
1	Electroplated G1	ASE16040	ASE16140	ASE16240
2	Electroplated G2	ASE16050	ASE16150	ASE16250
3	Electroplated G3	ASE16060	ASE16160	ASE16260
4	Abrasive G400	ASR56075	ASR56175	ASR56275
5	Abrasive G1000	ASR56080	ASR56180	ASR56280



STEP	TYPE	CODE T20	CODE T30	CODE T40
1	Electroplated G1	ASE12740	ASE12840	ASE12940
2	Electroplated G2	ASE12750	ASE12850	ASE12950
3	Electroplated G3	ASE12760	ASE12860	ASE12960
4	Abrasive G400	ASR52775	ASR52875	ASR52975
5	Abrasive G1000	ASR52780	ASR52880	ASR52980



STEP	TYPE	CODE V20	CODE V30	CODE V40
1	Electroplated G1	ASE13040	ASE13140	ASE13240
2	Electroplated G2	ASE13050	ASE13150	ASE13250
3	Electroplated G3	ASE13060	ASE13160	ASE13260
4	Abrasive G400	ASR53075	ASR53175	ASR53275
5	Abrasive G1000	ASR53080	ASR53180	ASR53280



STEP	TYPE	CODE Z h35	CODE Z h45	CODE Z h55
1	Electroplated G1	ASE14540	ASE14640	ASE14740
2	Electroplated G2	ASE14550	ASE14650	ASE14750
3	Electroplated G3	ASE14560	ASE14660	ASE14760
4	Abrasive G400	ASR54575	ASR54675	ASR54775
5	Abrasive G1000	ASR54580	ASR54680	ASR54780



STEP	TYPE	CODE 3-20	CODE 3-30	CODE 3-40
1	Electroplated G1	ASE13940	ASE14040	ASE14140
2	Electroplated G2	ASE13950	ASE14050	ASE14150
3	Electroplated G3	ASE13960	ASE14060	ASE14160
4	Abrasive G400	ASR53975	ASR54075	ASR54175
5	Abrasive G1000	ASR53980	ASR54080	ASR54180



STEP	TYPE	CODE 4-20	CODE 4-30	CODE 4-40
1	Electroplated G1	ASE14240	ASE14340	ASE14440
2	Electroplated G2	ASE14250	ASE14350	ASE14450
3	Electroplated G3	ASE14260	ASE14360	ASE14460
4	Abrasive G400	ASR54275	ASR54375	ASR54475
5	Abrasive G1000	ASR54280	ASR54380	ASR54480

custom profiles could be available on request

DM40 WHEELS

profiling **40**



40mm SD*
Medium size diameter, the external dimensions change according to the profile while smaller diameter remains always the same, SD* 40 mm (radius 20mm)

- Features**
- 40 mm SD*
 - 20 mm bore (22 mm upon request)
 - JoyLite JoyLite 40mm resin diamond polishing wheels with rubber body



Ø20 L38 AZT0559A
Ø20 L48 AZT0731A

*SD = smaller diameter

METAL BOND
Metal Body Wheels

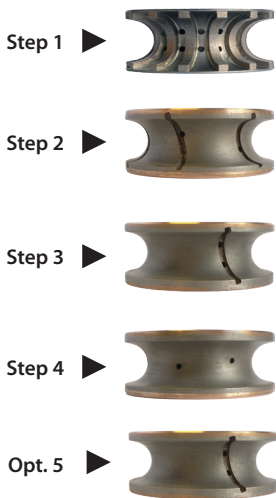

STANDARD Parameters					
TYPE	RPM	FEED (mm/min.)	FEED (inch/min.)	DISTANCE	
Step 1 ▶ Segmented G1	5000 - 6000	1000 - 1500	40-60	to profile	
Step 2 ▶ Continuous G3	5000 - 6000	1250 - 2500	50-100	0.30 mm 0.012"	
Step 3 ▶ Continuous G4	5000 - 6000	1250 - 2500	50-100	0.15 mm 0.006"	
Step 4 ▶ Continuous G5	5000 - 5500	1250 - 1500	50-60	0.10 mm 0.004"	
Opt. 5 ▶ Continuous G6F	4200	750 - 900	30-35	0.00 mm	



* Advisable the use of a cornerbreaker before the profiling set of wheels

RESIN BOND
Rubber Body Wheels

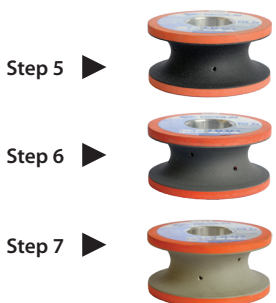

JoyLite Parameters				
TYPE	RPM	FEED (mm/min)	FEED (inch/min)	DISTANCE
Step 5 ▶ Resin G6	2800	1000	50	0 - 0.00 mm 0 - 0.00"
Step 6 ▶ Resin G7	2800	1000	50	0 - 0.00 mm 0 - 0.00"
Step 7 ▶ Resin G8	2800	1000	50	0 - 0.00 mm 0 - 0.00"

Note:
EVO Wheels can be used at standard operating parameters to yield longer tool life.

EVO parameters should only be used with machine capable of such settings. Using these settings with lower grade machinery can result in major damage to your machine and to the tools themselves.

DM40 WHEELS

profiling **40**



STEP	TYPE	A20 R5	A30 R5	A30 R15	A40 R20	
1	Segmented G1	ASS29405	ASS27005	ASS20105	ASS20205	✓
2	Continuous G3	ASF29420	ASF27020	ASF20120	ASF20220	✓
3	Continuous G4	ASF29425	ASF27025	ASF20125	ASF20225	
4	Continuous G5	ASF29430	ASF27030	ASF20130	ASF20230	✓
6F opt	Cont. w/slots G6F	ASF29435	ASF27035	ASF20135	ASF20235	✓
5	JoyLite™ G6	CSLA20R5920406 (note*)	CSLA30R5920406 (note*)	CSLA3099920406 (note*)	CSLA4099920406 (note*)	
6	JoyLite™ G7	CSLA20R5920407 (note*)	CSLA30R5920407 (note*)	CSLA3099920407 (note*)	CSLA4099920407 (note*)	✓
7	JoyLite™ G8	CSLA20R5920408 (note*)	CSLA30R5920408 (note*)	CSLA3099920408 (note*)	CSLA4099920408 (note*)	✓



STEP	TYPE	T20	T30	T30 R3	T40	
1	Segmented G1	ASS22705	ASS22805	ASS28305	ASS22905	✓
2	Continuous G3	ASF22720	ASF22820	ASF28320	ASF22920	✓
3	Continuous G4	ASF22725	ASF22825	ASF28325	ASF22925	
4	Continuous G5	ASF22730	ASF22830	ASF28330	ASF22930	✓
6F opt	Cont. w/slots G6F	ASF22735	ASF22835	ASF28335	ASF22935	✓
5	JoyLite™ G6	CSLT20R3920406 (note*)	CSLT30R5920406 (note*)	CSLT30R3920406 (note*)	CSLT4099920356 (note*)	
6	JoyLite™ G7	CSLT20R3920407 (note*)	CSLT30R5920407 (note*)	CSLT30R3920407 (note*)	CSLT4099920357 (note*)	✓
7	JoyLite™ G8	CSLT20R3920408 (note*)	CSLT30R5920408 (note*)	CSLT30R3920408 (note*)	CSLT4099920358 (note*)	✓



STEP	TYPE	Z25	Z35	Z45	
1	Segmented G1	ASS25605	ASS24505	ASS24605	✓
2	Continuous G3	ASF25620	ASF24520	ASF24620	✓
3	Continuous G4	ASF25625	ASF24525	ASF24625	
4	Continuous G5	ASF25630	ASF24530	ASF24630	✓
6F opt	Cont. w/slots G6F	ASF25635	ASF24535	ASF24635	✓
5	JoyLite™ G6	CSLZ3599920406	CSLZ3599920406	CSLZ4599920406	
6	JoyLite™ G7	CSLZ3599920407	CSLZ3599920407	CSLZ4599920407	✓
7	JoyLite™ G8	CSLZ3599920408	CSLZ3599920408	CSLZ4599920408	✓

NOTE*: 3pcs minimum order (G6+G7+G8 Joylite wheels) could be requested

✓ = NEW ADVISED SEQUENCE WITH 4 METAL and 2 JOYLITE WHEELS

DM40 WHEELS



STEP	TYPE	4-20	4-30	4-40	
1	Segmented G1	ASS24205	ASS24305	ASS24405	✓
2	Continuous G3	ASF24220	ASF24320	ASF24420	✓
3	Continuous G4	ASF24225	ASF24325	ASF24425	
4	Continuous G5	ASF24230	ASF24330	ASF24430	✓
6F opt	Cont. w/slots G6F	ASF24235	ASF24335	ASF24435	✓
5	JoyLite™ G6	CSL42099920406 (note*)	CSL43099920406 (note*)	CSL44099920356 (note*)	
6	JoyLite™ G7	CSL42099920407 (note*)	CSL43099920407 (note*)	CSL44099920357 (note*)	✓
7	JoyLite™ G8	CSL42099920408 (note*)	CSL43099920408 (note*)	CSL44099920358 (note*)	✓

NOTE*: 3pcs minimum order (G6+G7+G8 Joylite wheels) could be requested

✓ = NEW ADVISED SEQUENCE WITH 4 METAL and 2 JOYLITE WHEELS



custom profiles could be available on request



20mm SD*

Smaller size diameter Wheel, the external dimensions change according to the profile while smaller diameter remains always the same, SD* 20 mm (radius 10mm)

Features

- 20 mm SD*
- 1/2" GAS male connection
- JoyLite JoyLite resin diamond polishing Wheel



*SD = smaller diameter

New bond for longer life and better quality

All DM20 tools now comes **with measurements & geometry report** to ensure perfect shape of the tool

METAL BOND

Metal Body Wheels

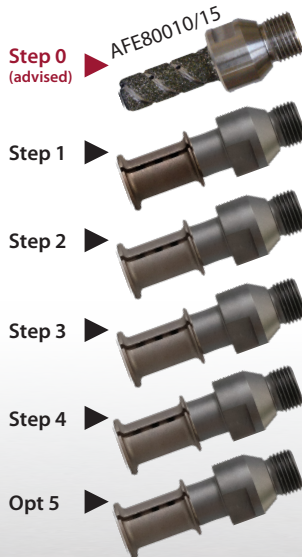

STANDARD Parameters					
TYPE	RPM	FEED (mm/min)	FEED (inch/min)	DISTANCE	
Electropl. D1*	4800-5500	250-500	-	To Profile	
Segmented G1(opt.)	6000 - 6500	750-900	30-35	To Profile	
Continuous G3	6000 - 6500	750-900	30-35	0.25 mm	
Continuous G4	6000 - 6500	750-900	30-35	0.20 mm	
Continuous G5	6000 - 6500	650-900	25-35	0.10 mm	
Continuous G6F	6000 - 6500	650-900	25-35	0.00 mm	

AVAILABLE PROFILES



* Advisable the use of AFE80010 Ø16 x 40 or AFE80015 Ø16 x 50 ELECTROPLATED FINGERBIT before the profiling set of wheels

RESIN BOND

Rubber Body Wheels

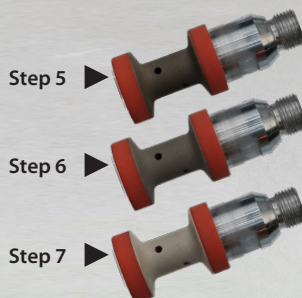

JoyLite Parameters				
TYPE	RPM	FEED (mm/min)	FEED (inch/min)	DISTANCE
Resin G6	2500	650-900	20-30	0 - 0.00 mm 0 - 0.00"
Resin G7	2500	650-900	20-30	0 - 0.00 mm 0 - 0.00"
Resin G8	2500	650-900	20-30	0 - 0.00 mm 0 - 0.00"

MINIMUM RADIUS 12 mm

DM20 WHEELS



4-30 3 cm



TYPE	CODE 3cm	
D1	AFE80010	
G1	DFG36011 (opt.)	✓
G3	DFG36013	✓
G4	DFG36014	
G5	DFG36015	✓
G6F	DFG360156 w/slots	✓
JLT G6	CSL4309991G206	
JLT G7	CSL4309991G207	✓
JLT G8	CSL4309991G208	✓

Z 4 cm



TYPE	CODE 4cm	
D1	AFE80015	
G1	DFG34051 (opt.)	✓
G3	DFG34053	✓
G4	DFG34054	
G5	DFG34055	✓
G6F	DFG34056 w/slots	✓
JLT G6	CSLZ459991G206	
JLT G7	CSLZ459991G207	✓
JLT G8	CSLZ459991G208	✓

T20 r3 2 cm



TYPE	CODE 2cm	
D1	AFE80010	
G1F	DFG3688A (opt.)	✓
G3	DFG36883	✓
G4	DFG36884	
G5	DFG36885	✓
G6F	DFG36886 w/slots	✓
JLT G6	CSLT20R391G206	
JLT G7	CSLT20R391G207	✓
JLT G8	CSLT20R391G208	✓

T30 r3 3 cm



TYPE	CODE 3cm	
D1	AFE80010	
G1F	DFG3422A (opt.)	✓
G3	DFG34223	✓
G4	DFG34224	
G5	DFG34225	✓
G6F	DFG34226 w/slots	✓
JLT G6	CSLT30R391G206	
JLT G7	CSLT30R391G207	✓
JLT G8	CSLT30R391G208	✓

T40 r3 4 cm



TYPE	CODE 4cm	
D1	AFE80015	
G1	DFG60081 (opt.)	✓
G3	DFG60083	✓
G4	DFG60084	
G5	DFG60085	✓
G6F	DFG60086 w/slots	✓
JLT G6	CSLT40R391G206	
JLT G7	CSLT40R391G207	✓
JLT G8	CSLT40R391G208	✓

Face DOWN

ZS30 4x4 DOWN 3 cm



TYPE	CODE 3cm	
D1	AFE80010	
G1	DFG42181 (opt.)	✓
G3	DFG42183	✓
G4	DFG42184	
G5	DFG42185	✓
G6F	DFG42186 w/slots	✓
JLT G6	CSLZS307T1G206	
JLT G7	CSLZS307T1G207	✓
JLT G8	CSLZS307T1G208	✓

Face DOWN

ZS40 4x4 DOWN 4 cm



TYPE	CODE 4cm	
D1	AFE80015	
G1	DFG44081 (opt.)	✓
G3	DFG44083	✓
G4	DFG44084	
G5	DFG44085	✓
G6F	DFG44086 w/slots	✓
JLT G6	CSLZS407T1G206	
JLT G7	CSLZS407T1G207	✓
JLT G8	CSLZS407T1G208	✓

Face UP

ZS30 4x4 UP 3 cm



TYPE	CODE 3cm	
D1	AFE80010	
G1	DFG41821 (opt.)	✓
G3	DFG41823	✓
G4	DFG41824	
G5	DFG41825	✓
G6F	DFG41826 w/slots	✓
JLT G6	CSLZS30071G206	
JLT G7	CSLZS30071G207	✓
JLT G8	CSLZS30071G208	✓

Face UP

ZS40 4x4 UP 4 cm



TYPE	CODE 4cm	
D1	AFE80015	
G1	DFG48791 (opt.)	✓
G3	DFG48793	✓
G4	DFG48794	
G5	DFG48795	✓
G6F	DFG48796 w/slots	✓
JLT G6	CSLZS407P1G206	
JLT G7	CSLZS407P1G207	✓
JLT G8	CSLZS407P1G208	✓

✓ = NEW ADVISED SEQUENCE WITH 4 METAL and 2 JOYLITE WHEELS

☺ = ADVISED

Top selling!
Face DOWN



A30 r3 DOWN 3 cm

TYPE	CODE 3cm	
D1	AFE80010	
G1	DFG3444A (opt.)	✓
G3	DFG34443	✓
G4	DFG34444	
G5	DFG34445	✓
G6F	DFG34446 w/slots	✓
JLT G6	CSLA30STT1G206	
JLT G7	CSLA30STT1G207	✓
JLT G8	CSLA30STT1G208	✓

Face DOWN



A40 r3 DOWN 4 cm

TYPE	CODE 4cm	
D1	AFE80015	
G1	DFG45311 (opt.)	✓
G3	DFG45313	✓
G4	DFG45314	
G5	DFG45315	✓
G6F	DFG45316 w/slots	✓
JLT G6	CSLA40R3T1G206	
JLT G7	CSLA40R3T1G207	✓
JLT G8	CSLA40R3T1G208	✓

Face UP



A30 r3 UP 3 cm

TYPE	CODE 3cm	
D1	AFE80010	
G1	DFG34431 (opt.)	✓
G3	DFG34433	✓
G4	DFG34434	
G5	DFG34435	✓
G6F	DFG34436 w/slots	✓
JLT G6	CSLA30R3R1G206	
JLT G7	CSLA30R3R1G207	✓
JLT G8	CSLA30R3R1G208	✓

Face UP

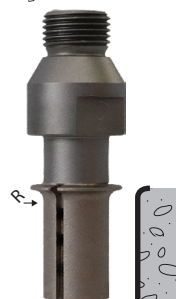

A30 r6 UP 3 cm

TYPE	CODE 3cm	
D1	AFE80010	
G1	DFG38171 (opt.)	✓
G3	DFG38173	✓
G4	DFG38174	
G5	DFG38175	✓
G6F	DFG38176 w/slots	✓
JLT G6	CSLA30R691G206	
JLT G7	CSLA30R691G207	✓
JLT G8	CSLA30R691G208	✓

Top selling!
Face DOWN



A30 r6 DOWN 3 cm

TYPE	CODE 3cm	
D1	AFE80010	
G1	DFG38591 (opt.)	✓
G3	DFG38593	✓
G4	DFG38594	
G5	DFG38595	✓
G6F	DFG38596 w/slots	✓
JLT G6	CSLA30R6T1G206	
JLT G7	CSLA30R6T1G207	✓
JLT G8	CSLA30R6T1G208	✓

✓ = NEW ADVISED SEQUENCE WITH 4 METAL and 2 JOYLITE WHEELS

New bond for longer life and better quality

10 SERIES

10mm SD*

Smaller size diameter Wheel, the external dimensions change according to the profile while smaller diameter remains always the same, SD* 10 mm (radius 5mm)

Features

- 10 mm SD*
- 1/2" GAS male connection (Cylindrical fitting upon request)
- JoyLite resin diamond polishing Wheel

*SD = smaller diameter

**Electroplated
Metal Body Wheels**

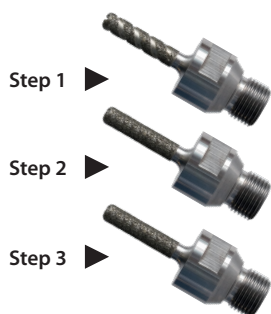

STANDARD Parameters			
TYPE	RPM	FEED	DISTANCE
Electropl. G1	7000	500-700 mm/min	0.30
Electropl. G2	7000	500-700 mm/min	0.15 mm
Electropl. G3	6000	500-700 mm/min	0.10 mm



**RESIN BOND
Rubber Body Wheels**

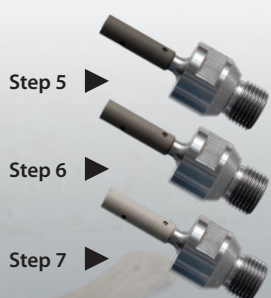

JOYLITE Parameters			
TYPE	RPM	FEED	DISTANCE
Resin G6	4000	400-600 mm/min	0.00 - 0.05
Resin G7	4000	400-600 mm/min	0.00 - 0.05
Resin G8	4000	400-600 mm/min	0.00 - 0.05

minimum radius:
6mm (1/4")



A r3

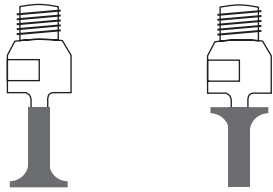

A r3	3 cm FACE DOWN	3 cm FACE UP
ELE G1	DFE6583C	TC-AR3FU0C
ELE G2	DFE6583B	TC-AR3FU0B
ELE G3	DFE6583A	TC-AR3FU0A
JLT G6	CSLA30STT1G106	TC-AR3FU06
JLT G7	CSLA30STT1G107	TC-AR3FU07
JLT G8	CSLA30STT1G108	TC-AR3FU08

PLEASE NOTE: 3 Kits minimum order

WARNING !!!
Very Fragile Tools

A r5

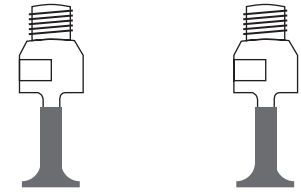

A r5	3 cm FACE DOWN	3 cm FACE UP
ELE G1	DFE6525C	TC-AR5FU0C
ELE G2	DFE6525B	TC-AR5FU0B
ELE G3	DFE6525A	TC-AR5FU0A
JLT G6	CSLA30R5S1G106	TC-AR5FU06
JLT G7	CSLA30R5S1G107	TC-AR5FU07
JLT G8	CSLA30R5S1G108	TC-AR5FU08

PLEASE NOTE: 3 Kits minimum order

T r3

VG



T r3	3 cm
ELE G1	DFE6587C
ELE G2	DFE6587B
ELE G3	DFE6587A
JLT G6	TC-TR306
JLT G7	TC-TR307
JLT G8	TC-TR308

PLEASE NOTE: 3 Kits minimum order

WARNING !!!
Very Fragile Tools

Z

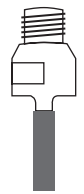

Z	3 cm	4 cm
ELE G1	DFE6672C	DFE6375C
ELE G2	DFE6672B	DFE6375B
ELE G3	DFE6672A	DFE6375A
JLT G6	CSLZ359991G106	CSLZ459991G106
JLT G7	CSLZ359991G107	CSLZ459991G107
JLT G8	CSLZ359991G108	CSLZ459991G108

PLEASE NOTE: 3 Kits minimum order

ZS

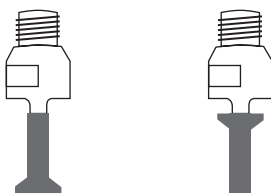

ZS	3 cm FACE DOWN	3 cm FACE UP
ELE G1	TC-ZSFD0C	TC-ZSFU0C
ELE G2	TC-ZSFD0B	TC-ZSFU0B
ELE G3	TC-ZSFD0A	TC-ZSFU0A
JLT G6	TC-ZSFD06	TC-ZSFU06
JLT G7	TC-ZSFD07	TC-ZSFU07
JLT G8	TC-ZSFD08	TC-ZSFU08

PLEASE NOTE: 3 Kits minimum order

WARNING !!!
Very Fragile Tools

4

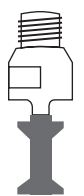

4	2 cm	3 cm
ELE G1	DFE7054C	DFE7053C
ELE G2	DFE7054B	DFE7053B
ELE G3	DFE7054A	DFE7053A
JLT G6	CSL4209991G106	CSL4309991G106
JLT G7	CSL4209991G107	CSL4309991G107
JLT G8	CSL4209991G108	CSL4309991G108

PLEASE NOTE: 3 Kits minimum order

NOTE: Item Codes beginning with "TC" are temporary codes

BEVELLING

profiling



COMBY BEVELLING SYSTEM *PLEASE NOTE: the number of the wheels to be used (and their grits) may vary depending on the bevel dimensions and the desired finishing level*
10 mm 45°



TYPE	Single Wheel CODE	THICKNESS	BORE	GRIT
FCC	ASF17210	10 mm	35 mm	G1
FCC	ASF17220	10 mm	35 mm	G3
FCC	ASF17225	10 mm	35 mm	G4
FCC	ASF17230	10 mm	35 mm	G5
JoyLite	CSLY10CMB35606	10 mm	35 mm	-
JoyLite	CSLY10CMB35607	10 mm	35 mm	-
JoyLite	CSLY10CMB35608	10 mm	35 mm	-

*For small bevel suggested start from P3
CODES INDICATE A SINGLE WHEEL
TO ORDER THE COMPLETE COMBY SYSTEM MUST SPECIFY 2 PCS.*



SPACER

Comby Beveling Wheels



TYPE	CODE	THICKNESS	BORE	GRIT
Spacer	AZT0788A	20 mm	35 mm	-
Spacer	AZT0789A	30 mm	35 mm	-
Spacer	AZT0790A	40 mm	35 mm	-

45° FACE UP TIPS (BEVELLING ROUTERS)

Continuous Rim



TYPE	CODE	THICKNESS	FITTING	GRIT
FCC	DFG24151	10 mm	M12	G1
FCC	DFG24152	10 mm	M12	G2
FCC	DFG24153	10 mm	M12	G3
FCC	DFG22021**	10 mm	M12	G1
FCC	DFG22022**	10 mm	M12	G2
FCC	DFG22023**	10 mm	M12	G3



TOOL HOLDER

For 45° Face Up Tips (Beveling Routers)



TYPE	CODE	Size	FITTING
Tool Holder	AZT1518A	Ø17 L46 Lu60	1/2 Gas > M12



CALIBRATER

Segmented $F=1/2G$ as



CODE	SIZE
DSS06361	Ø85 mm

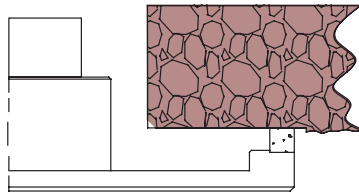

CALIBBREAKER

Segmented $F=1/2G$ as



CODE	SIZE
DFS2676S	Ø135 x 14 mm

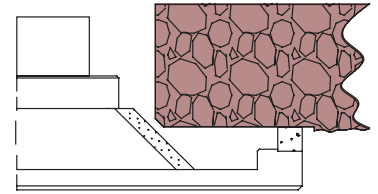

45° BEVELLING WHEEL

Electroplated - B35



CODE	SIZE
DSE2444B	Ø76 mm

RADIUS BEVELLING WHEEL

Electroplated - B35



CODE	SIZE
DSE2444R	Ø71 mm

CODE	SIZE
DSS2444S	Ø140 mm

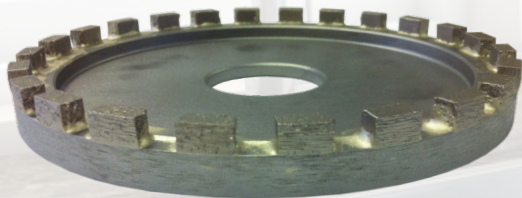

+



+

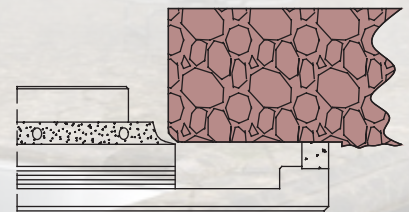
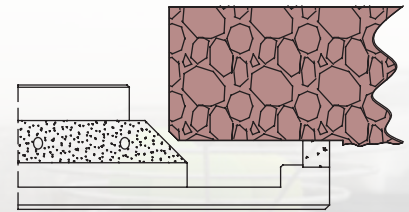

CUSTOM PROFILING WHEELS



*Every kind of profile can be done!
Electroplated wheels for marble
or segmented for granite.
With 1/2 gas or other fitting.*

Custom made



*Send us your profile
PDF, DWG or DXF*



*Our technicians will make
our custom wheels*

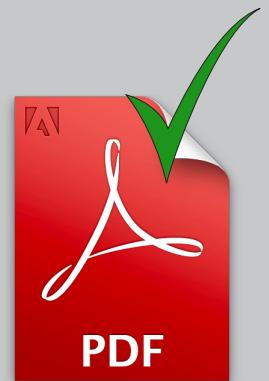

Confirm our drawing



*Get your custom tools
ready to use!*

closer to you
experience the power of italian technology

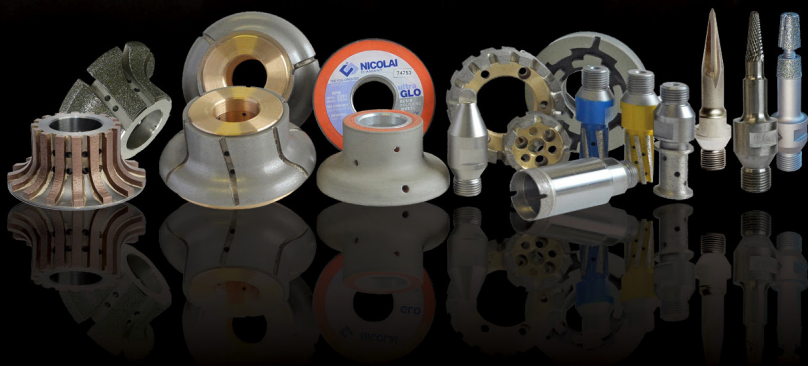

Nicolai Diamant Srl

Via Dorsale, 13, 54100
Massa Carrara (MS), Italy
Tel: +39 0585 79971
Fax: +39 0585 799799

PREMIUM STRAIGHT EDGE

kitchen top

SUPER Z WHEELS

Ultra High Speed Segmented Calibrating Wheels



CODE	SIZE	DISTANCE	RPM	FEED
ASSE4605M3P ☺	Ø80 x 45 mm	0.8 mm	4500-5400	5000 mm/min
ASSE5241M3P	Ø50 x 45 mm	1.6 mm	4800-5500	2500-3800 mm/min
ASSE5242M3P	Ø40 x 45 mm	3.5 mm		2000-2500 mm/min



CYLINDRICAL WHEELS FOR SINKS

Electroplated F=1/2Gas



CODE	SIZE	GRIT	RPM	FEED
DFE4026C	Ø25 x 50 mm	Grit 1	5000 - 5500	600 - 800 mm/min
DFE4026H	Ø25 x 50 mm	Grit 2		600 - 800 mm/min
DFE4026A	Ø25 x 50 mm	Grit 3	4800 - 5200	800 - 1000 mm/min
DFE3982C	Ø50 x 50 mm	Grit 1	5000 - 5500	600 - 800 mm/min
DFE3982H	Ø50 x 50 mm	Grit 2		600 - 800 mm/min
DFE3982A	Ø50 x 50 mm	Grit 3	4800 - 5200	800 - 1000 mm/min



LINEBUSTER - Profile Z

Resin Diamond Wheels



CODE	SIZE	BORE	RPM	FEED
ASL84560	Ø45 x 35 mm	B20	3000	600 mm/min 24 inches/min
DSL34326	Ø45 x 35 mm	B22		600 mm/min 24 inches/min
DSL34316	Ø60 x 40 mm	B22	2800	700 mm/min 28 inches/min
DSL34336	Ø60 x 40 mm	B35		700 mm/min 28 inches/min
ASL34560	Ø78 x 35 mm	B35	2600	800 mm/min 32 inches/min
ASL34660 ☺	Ø78 x 45 mm	B35		
ASL34760	Ø78 x 55 mm	B35		
ASL34N60	Ø78 x 65 mm	B35		
ASL38560	Ø78 x 105 mm	B35		



Oscillation:

⬆️ 1mm UP

⬇️ 1mm DOWN

Feed UP / DOWN
20.000 mm/min.

1/2gas fitting

CODE	SIZE	FITTING	RPM	FEED
DFL34056	Ø20 x 45 mm	1/2GAS	3000	600 mm/min 24 inches/min

WEAR RATE: 0.005 mm/mt.



DFL34056

Linebuster resin diamond wheel for Granite & ES
Use after metal bond Wheel and before
JoyLite Polishing Wheel.
Spindle oscillation is recommended

☺ = ADVISED



ENGRAVING MILLS (CYLINDRICAL)

Engraving and Flush Fit Minimum Radius 3 > 7.5 mm - F=1/2Gas

CODE	SIZE	RPM	FEED
AFF10005	Ø8 x 12 mm	6000-7000	150 - 300 mm/min x 2-5 mm deep
AFF10010	Ø10 x 12 mm		
AFF10015	Ø12 x 12 mm		
AFF10020	Ø15 x 12 mm		



CODE	SIZE	SHANK	RPM	FEED
ETS00017	Ø10 L75	10 / 10	6000-7000	100 - 200 mm/min x 2-5 mm deep
ATS1215C	Ø12 L75	10 / 10		
ATS1415C	Ø14 L75	10 / 10		



1/2 GAS HOLDERS (economic line)

1/2 Gas > Erg20



CODE	SIZE	THREAD	FITT MACHINE	FITT TOOL
AZT0571A *	L120mm	Right	1/2GAS	Erg20
AZT0571B *	L120mm	Left	1/2GAS	Erg20
AZZ00013 **	PLIERS		D6 mm	Erg20
AZZ00014 **	PLIERS		D8 mm	Erg20
AZZ0890A ***	CLAMP			

1/2 GAS HOLDERS (professional line)

1/2 Gas > Erg32



CODE	SIZE	THREAD	FITT MACHINE	FITT TOOL
AZT4194A *	L52 mm	Right	1/2 Gas	Erg32
AZT4194B *	L110 mm	Left	1/2 Gas	Erg32
AZZ00005 ***	Pliers		D6 mm	Erg32
AZZ00006 ***	Pliers		D8 mm	Erg32
AZZ00007 ***	Pliers		D10 mm	Erg32
AZZ00010 ***	Pliers		D20 mm	Erg32
AZZ0889A **	Clamp			

NO-CORING BIT HOLDER

Can also be used for T31



CODE	SIZE
AZT0572B	1/2 Gas > D10



HOLE

ENGRAVING

FLUSH FIT

ONLY FOR $\phi > 8$

FLUSH FIT

kitchen top



Ø20 CROWN MILLS

SEGMENTED for Incremental Cutting and Flush Fit minimum radius 10 mm



CODE	SIZE	FITTING	MATERIAL	RPM	FEED
CFS4C077 ☺	Ø20 x 13 mm	M12	GR. & E.S.	4800-5500	400 - 1000 mm/min 18 - 40 inches/min x 3mm deep
CFS4C042	Ø20 x 13 mm	M10	GR. & E.S.		
CFS4C086	Ø20 x 13 mm	M14	GR. & E.S.		
AFS40075	Ø15 x 20 mm	1/2 GAS	GR. & E.S.		
CFS40031	Ø10 x 10 mm	1/2 GAS	GR. & E.S.		
CFS40031CER	Ø10 x 10 mm	1/2 GAS	CERAMICS		
CFS40032CER	Ø12 x 10 mm	1/2 GAS	CERAMICS		
CFS4C078	Ø20 x 10 mm	M12	CERAMICS		
CFS40073CER	Ø20 x 12 mm	1/2 GAS	CERAMICS		



See page A92 for LEFT THREADED crown mills

Ø20 CROWN MILL

ELECTROPLATED for Incremental Cutting and Flush Fit minimum radius 10 mm



CODE	SIZE	FITTING	RPM	FEED
AFE41010	Ø20 x 10 mm	M10	4800-5500	400 - 1000 mm/min x 3-5mm deep
AFE41020 ☺	Ø20 x 10 mm	M12		



TOOL HOLDER for Ø20 Crown Mill

1/2 Gas Fitting

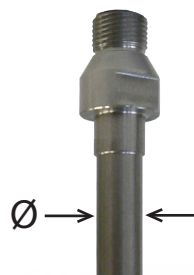

CODE	SIZE	FITTING
AZT1518G	Ø17 x 30 mm	M10
AZT1518E ☺	Ø17 x 30 mm	M12
AZT1518B	Ø17 x 60 mm	M10
AZT1518A ☺	Ø17 x 60 mm	M12
AZT1518F	Ø18 x 100 mm	M12
AZT1518T	Ø18 x 120 mm	M12

PCD CYLINDRICAL MILL

Minimum Radius 5 mm - 10 mm Shank



CODE	SIZE	RPM	FEED
AFW80100	Ø10 x 6 mm	8000 - 10000	150 - 250 mm/min x 3mm deep



USED TO RECTIFY THE CUT IN ORDER TO ACHIEVE A PERFECT ANGLE





R.5 MM FOR UNDER-UP SLAB
R.17 MM FOR NORMAL SLAB

MINIMUM
RADIUS

FOR A BETTER FINISHING
IT'S POSSIBLE TO USE
TWO ELECTROPLATED WHEELS
+ POLISHING SET



AZT3259A

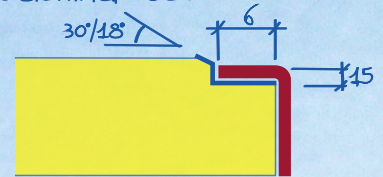

TOOLS FOR 30° LUXURY FLUSH FIT

Available on request



STEP	TYPE	UNDER-UP SLAB SOLUTION			NORMAL SLAB SOLUTION		
		CODE	SIZE	FITTING	CODE	SIZE	FITTING
1	Segmented	CFS4C077	Ø20 x 10 mm	1/2 Gas	CFS4C077	Ø20 x 10 mm	M12
2	Electroplated	DFE6206B	Ø32/45 30°	1/2 Gas	DFE6799B	Ø18/32 30°	1/2 Gas
3	Electroplated	DFE6206A	Ø32/45 30°	1/2 Gas	DFE6799A	Ø18/32 30°	1/2 Gas
4	JoyLite G6	CSI1AB06I2	Ø32/45 30°	1/2 Gas	n.a.		
5	JoyLite G7	CSI1AB07I2	Ø32/45 30°	1/2 Gas	CSL3030991G187	Ø18/32 30°	1/2 Gas
6	JoyLite G8	CSI1AB08I2	Ø32/45 30°	1/2 Gas	CSL3030991G188	Ø18/32 30°	1/2 Gas

TOOLS FOR 18° LUXURY FLUSH FIT

Available on request



STEP	TYPE	UNDER-UP SLAB SOLUTION			NORMAL SLAB SOLUTION		
		CODE	SIZE	FITTING	CODE	SIZE	FITTING
1	Segmented	on request	Ø32 L42 mm	1/2 Gas	AFS40015	Ø20 x 10 mm	M12
2	Electroplated	DSE0881E	18°	B22	on request	18°	B22
3	Electroplated	DSE0881C	18°	B22	on request	18°	B22
4	JoyLite G6	CSL18G99922706	18°	B22	on request	18°	B22
5	JoyLite G7	CSL18G99922707	18°	B22	on request	18°	B22
6	JoyLite G8	CSL18G99922708	18°	B22	on request	18°	B22

LUXURY FLUSH FIT

kitchen top



UNDER-UP SLAB SOLUTION

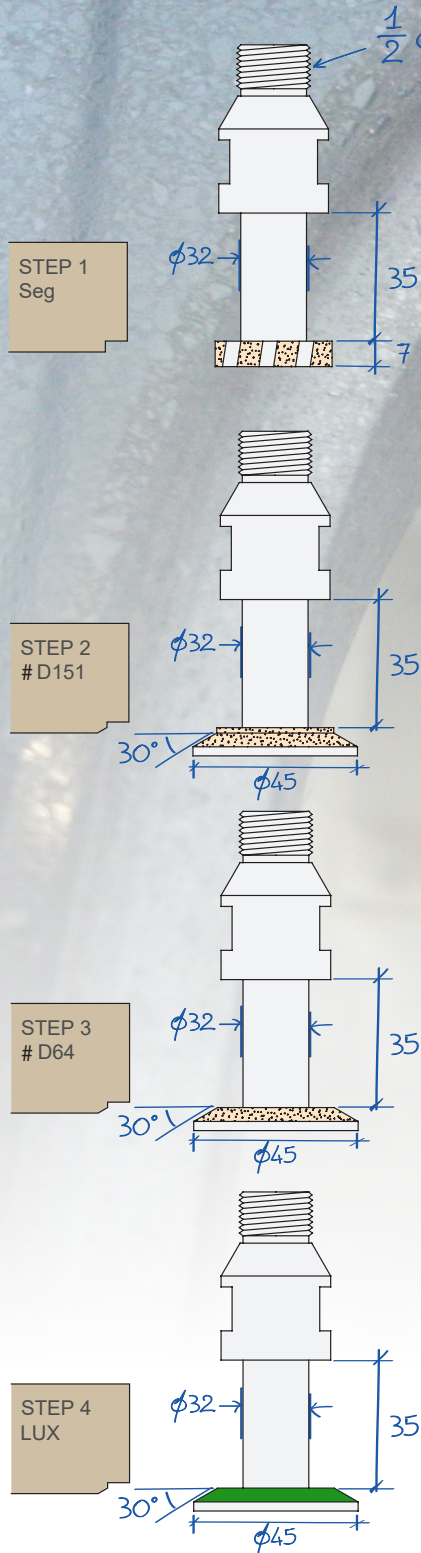

NORMAL SLAB SOLUTION

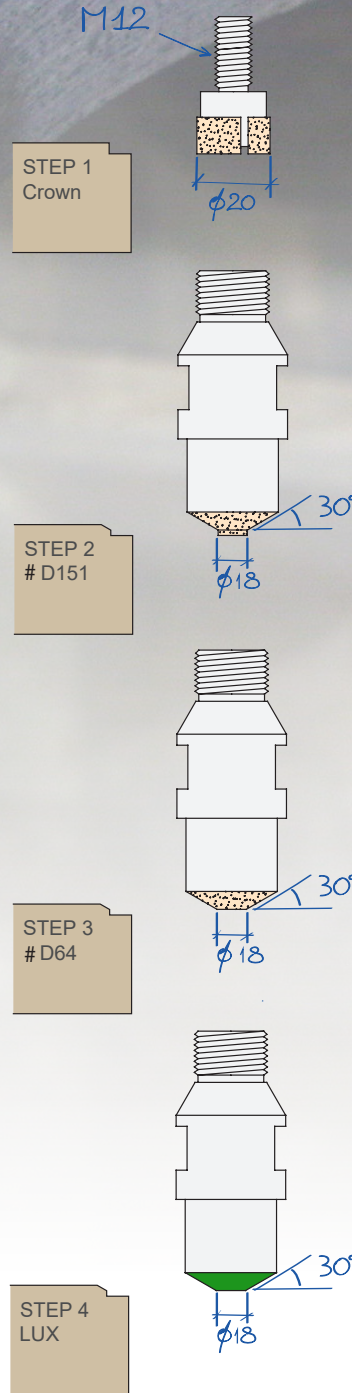



CORE BITS

Thin Wall - F=1/2Gas

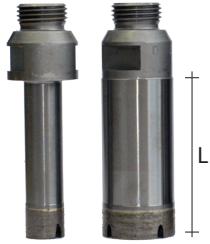

CODE	SIZE	FITTING
APF11030	Ø30 x 55 mm	1/2 Gas

seq.A
step.1

seq.B
step.1



BLADE for Breton Machines

Electroplated



CODE	SIZE	MACHINE	FITTING	REINFORCES
ADSE1000	Ø150 x 5 mm	Breton	B25+3HØ8/55	Brased Sides

seq.A
step.2

RPM: 2500 - Feed: 600-800 mm/min.
With this blade you can bypass the Cup Wheel's step



BLADE for CMS Brembana

Locking Flat Flange Included



CODE	SIZE	MACHINE	FITTING	REINFORCES
ADS00018	Ø210 x 3.6 mm	CMS Brembana	B50 - 6+6H	Z24 20 x 3.6
ADS00015	Blades			
HF05006D65063S	Fitting			
AZT4074A *	Flat Flange			

seq.B
step.2

1st cut: RPM: 3400 - Enter Feed: 200 mm/min. - Working Feed: 800 mm/min.
2nd cut: RPM: 3400 - Enter Feed: 500 mm/min. - Working Feed: 1200 mm/min.

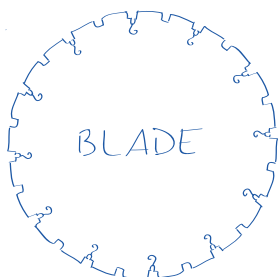

+



+

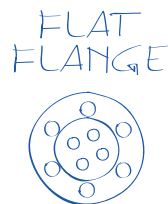

=

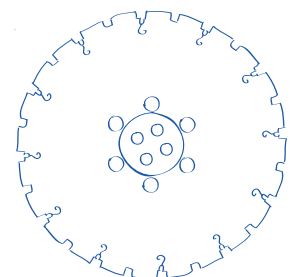

SQUARE SINK

kitchen top



CONIC CUP WHEEL for CMS Brembana / Prussiani Continuous Rim



CODE	SIZE	GRIT	FITTING	MACHINE
DSG26421	Ø120 x 10 mm	G1	B50	CMS Brembana
DSG26423	Ø120 x 10 mm	G3	B50	

RPM: 3400

REMOVAL:
1st step: Feed: 700 - Removal: 0.35
2nd step: Feed: 700 - Removal: 0.10

seq.B
step.3



PROGLO EDGE for SQUARE SINKS Polishing Wheels

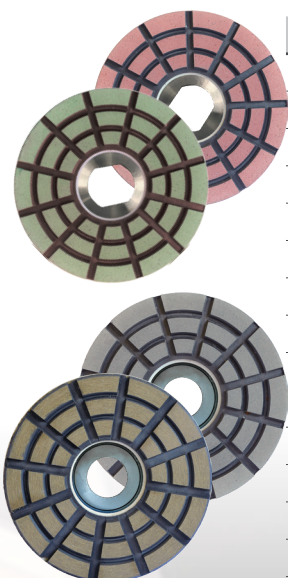

CODE	SIZE	GRIT	FITTING	MACHINE	RPM	FEED	RMV.	COMP.
ALRPD4GEM0120	Ø140 5.5 inches	100	Magnetic	Breton/ Prussiani	1200	1000/1200 mm/min.	0.15	0.01
ALRPD4GEM0220		200					0.10	0.01
ALRPD4GNM0400		400					0.05	0.01
ALRPD4GNM0800		800					0.25	
ALRPD4GNM1800		1500					0.00	
ALRPD4GNM3500		3500					0.00	
ANGLE								
ALRPD4GE0220	Ø140 5.5 inches	200	Bore 40	CMS Bremb.	3750	600 mm/min. (*)	0.00	0.5
ALRPD4GN0400		400					0.00	0.5
ALRPD4GN0800		800					0.00	0.5
ALRPD4GN1800		1500					0.00	0.5
ALRPD4GN3500		3500					0.00	0.5

seq.A
step.3

seq.B
step.4



(*) FEED: 700 (in) / 600 (work) / 4000 (out)

NOTE: each 2 or 3 sinks the wheels should be measured again

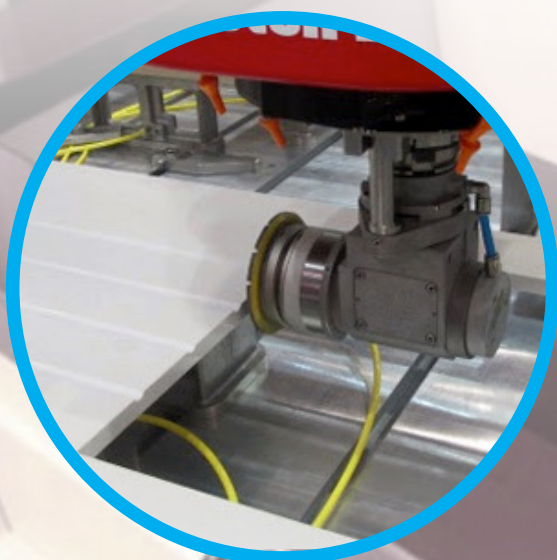

SQUARE
SINK 90°

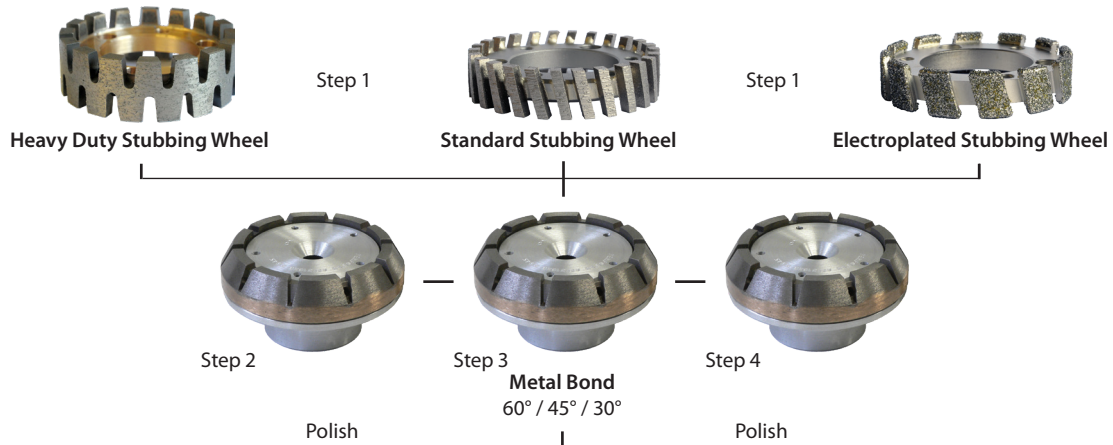

Denver, Intermac, Bimatech
Electronic pressure



JoyLux Piano
Gr. 50 * / 100 / 200

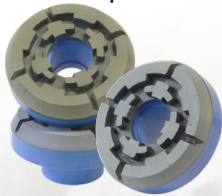

Resin Chamfering Piano
Gr. 500 / 1000 / 2000



JoyLux Piano
Gr. 3000



Buff Piano
Only for Granite

Prussiani, CMS Brembana
Telescopic adaptor (pag. A81)



JoyLux Piano
Gr. 50 * / 100 / 200

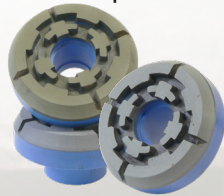

Resin Chamfering Piano
Gr. 500 / 1000 / 2000

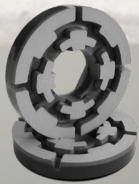

JoyLux Piano
Gr. 500 / 1000 / 2000 / 3000



Buff Piano
Only for Granite

Denver, Intermac, Bimatech
Electronic pressure

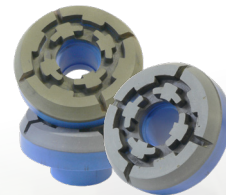

Resin Chamfering Piano
Gr. 50 * / 100 / 200 / 500
1000 / 2000 / 3000



Buff Piano
Only for Granite

* only for hard materials

STEP	RPM	FEED
1	4500-4800	400-600
2	4500-4700	1000-1200
3	4500-4700	1000-1200
4	4500-4700	1000-1200
5	850-900	2500-3000

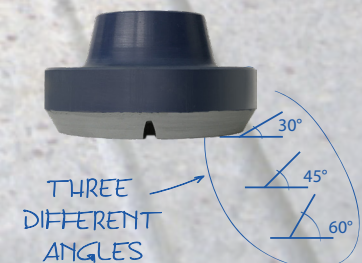

Step 5

STUBBING WHEELS

kitchen top



STUBBING WHEEL TURBO

For Breton, Bimatech, CMS Brembana, Denver, Intermac, Ravelli



CODE	SIZE	FITTING	RPM	FEED
AMC00092	Ø92 x 30 mm	B50 - 3+3H	4300-4500	400-600 mm/min 16-24 inches/min



STUBBING WHEEL TURBO

For Breton, Bimatech, CMS Brembana, Denver, Intermac, Ravelli



CODE	SIZE	FITTING	RPM	FEED
AMC00095	Ø92 x 30 mm	B50 - 3+3H	4300-4500	400-600 mm/min 16-24 inches/min



STUBBING WHEEL TURBO

For Breton, Bimatech, CMS Brembana, Denver, Intermac, Ravelli



CODE	SIZE	FITTING	RPM	FEED
AMC00093	Ø92 x 30 mm	B50 - 4+4H	4300-4500	400-600 mm/min 16-24 inches/min



STUBBING WHEEL TURBO

For Breton, Bimatech, CMS Brembana, Denver, Intermac, Ravelli



CODE	SIZE	FITTING	RPM	FEED
AMC00096	Ø92 x 30 mm	B50 - 4+4H	4300-4500	400-600 mm/min 16-24 inches/min



STUBBING WHEEL TURBO

Normal diameter



CODE	SIZE	FITTING	RPM	FEED
AMC00054	Ø50 x 20 mm	B14 - 3+3	4500-5000	250-500 mm/min 10-20 inches/min
AMC00055 ☺	Ø50 x 20 mm	B10 - 2+2		250-500 mm/min 10-20 inches/min
AMC00056	Ø50 x 20 mm	B14 - 3+3	4500-5000	250-500 mm/min 10-20 inches/min
AMC00057 ☺	Ø50 x 20 mm	B10 - 2+2		250-500 mm/min 10-20 inches/min



☺ = ADVISED

STUBBING WHEELS

kitchen top



STUBBING WHEELS

Segmented - For Breton, Bimatech, CMS Brembana, Denver, Intermac, Ravelli (STANDARD BOND: FB2)



AMS00148
NEW!

CODE	SIZE	FITTING	RPM	FEED
AMS00030	Ø85 x 20 mm	B50 - 3+3H		
AMS00089 ☺	Ø88 x 20 mm	B50 - 3+3H		
DSS3848S	Ø88 x 30 mm	B50 - 3+3H	4300-4500	400-600 mm/min 16-24 inches/min
AMS00148 ☺	Ø89 x 30 mm	B50 - 3+3H		



STUBBING WHEELS

Segmented - For Bavelloni



CODE	SIZE	FITTING	RPM	FEED
AMS00085	Ø85 x 20 mm	B50 - 4+4H		
DSS3417S	Ø88 x 30 mm	B50 - 4+4H	4300-4500	400-600 mm/min 16-24 inches/min
AMS00118 ☺	Ø88 x 30 mm	B50 - 4+4H		
AMS00180 ☺	Ø89 x 30 mm	B50 - 4+4H		



STUBBING WHEELS

Segmented - For Prussiani

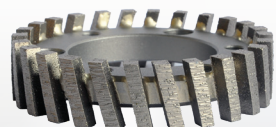

CODE	SIZE	FITTING	RPM	FEED
AMS00025	Ø80 x 20 mm	B20 - 4+4H		
AMS00030	Ø85 x 20 mm	B50 - 3+3H	4300-4500	400-600 mm/min 16-24 inches/min
AMS00089	Ø88 x 20 mm	B50 - 3+3H		
AMS00148 ☺	Ø89 x 30 mm	B50 - 3+3H		
AMS00042	Ø100 x 20 mm	B50 - 3+3H	3800-4300	



STUBBING WHEELS

Segmented - For Thibaut



CODE	SIZE	FITTING	RPM	FEED
AMS00050	Ø150 x 15 mm	B60 - 6+6H	3500-3800	400-500 mm/min 16-20 inches/min
AMS00055	Ø150 x 20 mm	B60 - 6+6H		



STUBBING WHEELS

Segmented - Small diameter

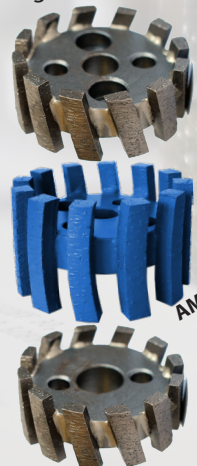

AMS00178
NEW!

CODE	SIZE	FITTING	RPM	FEED
EMS00143	Ø53 x 20 mm	B14 - 3+3		
AMS00020 ☺	Ø50 x 20 mm	B10 - 2+2		
AMS00178 ☺	Ø53 x 30 mm	B10 - 2+2	4500-5000	250-500 mm/min 10-20 inches/min
EMS00095	Ø50 x 20 mm	B14 - 3+3		
AMS00021	Ø53 x 20 mm	B10 - 2+2		
EMS00011	Ø46 x 20 mm	B14 - 3+3		



AMS00002 ☺	Ø40 x 20 mm	B8.5 TSEI +2B	4800-5500	250-500 mm/min 10-20 inches/min
------------	-------------	---------------	-----------	------------------------------------

☺ = ADVISED

STUBBING WHEELS

kitchen top



STUBBING WHEELS

Electroplated - For Breton, Bimatech, CMS Brembana, Denver, Intermac, Ravelli



CODE	SIZE	FITTING	RPM	FEED
AME00030	Ø85 x 20 mm	B50 - 3+3H	5000-5500	500-600 mm/min 20-24 inches/min



STUBBING WHEELS

Electroplated - For Bavelloni



CODE	SIZE	FITTING	RPM	FEED
AME00076	Ø85 x 20 mm	B50 - 4+4H	5000-5500	500-600 mm/min 20-24 inches/min



STUBBING WHEELS

Electroplated - For Bavelloni



CODE	SIZE	FITTING	RPM	FEED
AME00025	Ø80 x 20 mm	B20 - 4+4H	5000-5500	500-600 mm/min 20-24 inches/min
AME00030	Ø85 x 20 mm	B50 - 3+3H		
AME00031 new	Ø85 x 20 mm	B50 - 3+3H	Special grit for high speed	
AME00075	Ø100 x 20 mm	B50 - 3+3H	3800-4300	400-600 mm/min 16-24 inches/min
AME00076	Ø85 x 20 mm	B50 - 4+4H	5000-5500	500-600 mm/min 20-24 inches/min



STUBBING WHEELS

Electroplated - For Rectifying

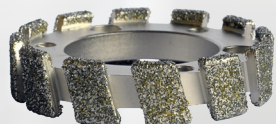

CODE	SIZE	FITTING	RPM	FEED
DSE3649D (D602)	Ø100 x 20mm	B50 - 3+3H	4000-4500	500-600 mm/min 20-24 inches/min
DSE3649E (D851)	Ø100 x 20mm	B50 - 3+3H	4000-4500	500-600 mm/min 20-24 inches/min



STUBBING WHEELS

Electroplated - Small diameter



CODE	SIZE	FITTING	RPM	FEED
AME00020 ☺	Ø50 x 20 mm	B10 - 2+2	4500-5000	250-500 mm/min 10-20 inches/min
AME00028	Ø50 x 20 mm	B14 - 3+3		
AME00024 new	Ø50 x 20 mm	B10 - 2+2	Special grit for high speed	
AME00015 ☺	Ø40 x 20 mm	B8.5 TSEI +2B	4800-5500	250-500 mm/min 10-20 inches/min



☺ = ADVISED



DRAINBOARD WHEELS

Ø112 mm - 35 mm bore



STEP	TYPE	CODE 30°	CODE 45°	CODE 60°
2	✓ Segmented G1 ☺	ASS31105	ASS31205	ASS31007
3	Continuous slot G3	ASF31120	ASF31220	ASF31020
4	Continuous slot G4	ASF31130	ASF31230	ASF31030



STEP	TYPE	CODE 30°	CODE 45°	CODE 60°
2	✓ ELE D2 ☺	ASE31150	ASE31250	ASE31050
3	✓ ELE D3 ☺	ASE31160	ASE31260	ASE31060



best sequence: Seg G1 + ELE D2 + ELE D3

DRAINBOARD JOY EG LUX WHEELS for Polishing

Resin - Ø100 mm

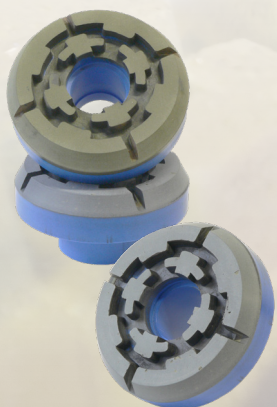

STEP	CODE 30°	CODE 45°	CODE 60°	GRIT	FITTING
2			CLRR6105	50	B35 mm
2	CLRR3110	CLRR4610	CLRR6110	100	B35 mm
2	CLRR3115	CLRR4615	CLRR6115	200	B35 mm
2	CLRR3120	CLRR4620	CLRR6120	500	B35 mm
2	CLRR3125	CLRR4625	CLRR6125	1000	B35 mm
2	CLRR3130	CLRR4630	CLRR6130	2000	B35 mm
2	CLRR3135	CLRR4635	CLRR6135	3000	B35 mm
2	CLRR3205	CLRR4705	CLRR6205	50	Magnetic
2	CLRR3210	CLRR4710	CLRR6210	100	Magnetic
2	CLRR3215	CLRR4715	CLRR6215	200	Magnetic
2	CLRR3220	CLRR4720	CLRR6220	500	Magnetic
2	CLRR3225	CLRR4725	CLRR6225	1000	Magnetic
2	CLRR3230	CLRR4730	CLRR6230	2000	Magnetic
2	CLRR3235	CLRR4735	CLRR6235	3000	Magnetic

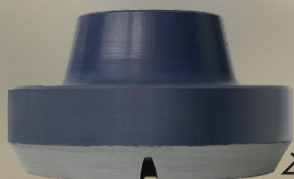

30°/45°/60°

☺ = ADVISED

DRAINBOARD

kitchen top



FLAT DRAINBOARD JOY EG LUX WHEELS for Polishing

Resin - For Flat Surfaces - Ø100 mm

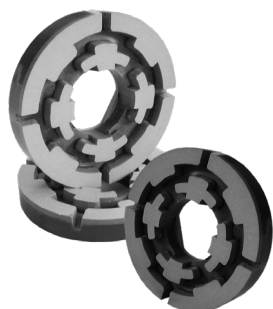

STEP	TYPE	MAGN. FIT.	B35 FIT.	SNAIL FIT.
opt	Continuous slotted G50	CLRR0105	CLRR0205	CLRRNS05
8	Continuous slotted G100	CLRR0110	CLRR0210	CLRRNS10
9	Continuous slotted G200	CLRR0115	CLRR0215	CLRRNS15
10	Continuous slotted G500	CLRR0120	CLRR0220	CLRRNS20
11	Continuous slotted G1000	CLRR0125	CLRR0225	CLRRNS25
12	Continuous slotted G2000	CLRR0130	CLRR0230	CLRRNS30
13	Continuous slotted G3000	CLRR0135	CLRR0235	CLRRNS35



DRAINBOARD BUFF WHEELS for Granite

For Flat Surfaces - Ø100 mm



STEP	TYPE	CODE	GRIT	FITTING
14	BUFF	CLR02040		Magnetic
14	BUFF	CLR02240		SNAIL



ADAPTOR FOR WHEELS W/ B35

OPTIONAL if you don't use cones



CODE	FITTING	HOLDER
AZT2532A	1/2 Gas	35 x 38 + M12



DRAINBOARD GROOVE MILLS Ø12.7 - Radius 6.35 - L10 mm Segmented - F=1/2Gas



CODE Ø12	TYPE	REMOVAL	RPM	FEED
DFS34295	Segmented G1	to profile	6000-6800	400-600 mm/min 16-24 inches/min
DFS34293	Segmented G3	0.30 mm / 0.012"		
DFS34294	Segmented G4	0.20 mm / 0.008"		
DFS34295	Segmented G5	0.15 mm / 0.006"		



DRAINBOARD GROOVE MILLS Ø12 - Radius 6.35 - L10 mm Solid - F=1/2Gas



CODE Ø12	TYPE	REMOVAL	RPM	FEED
AFF20023 ☺	FCC G1	to profile	6000-6800	400-600 mm/min 16-24 inches/min
AFF20025 ☺	FCC G3	0.30 mm / 0.012"		
AFF20026 ☺	FCC G4	0.20 mm / 0.008"		
AFF20027 ☺	FCC G5	0.15 mm / 0.006"		



GROOVE WIDTH IS DEPENDANT ON TOOL DEPTH

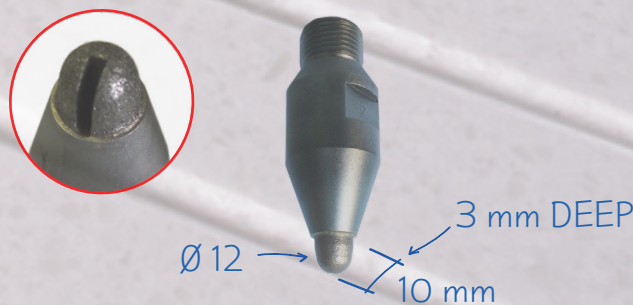

☺ = ADVISED

DRAINBOARD GROOVE

kitchen top



DRAINBOARD GROOVE MILLS Ø15 - Radius 7.5 - L10 mm
Segmented - F=1/2Gas



CODE Ø15	TYPE	REMOVAL	RPM	FEED
DFS39165	Segmented G1	to profile		
DFS39163	Segmented G3	0.30 mm / 0.012"	6000-6800	400-600 mm/min 16-24 inches/min
DFS39164	Segmented G4	0.20 mm / 0.008"		
DFS39165	Segmented G5	0.15 mm / 0.006"		



DRAINBOARD GROOVE MILLS Ø15 - Radius 7.5 - L10 mm
Solid - F=1/2Gas



CODE Ø15	TYPE	REMOVAL	RPM	FEED
AFF20015 ☺	FCC G1	to profile		
AFF20020 ☺	FCC G3	0.30 mm / 0.012"	6000-6800	400-600 mm/min 16-24 inches/min
AFF20021 ☺	FCC G4	0.20 mm / 0.008"		
AFF20022 ☺	FCC G5	0.15 mm / 0.006"		



GROOVE WIDTH IS DEPENDANT ON TOOL DEPTH



☺ = ADVISED



DRAINBOARD GROOVE WHEELS Ø200x12 Radius 6 mm 50 mm bore

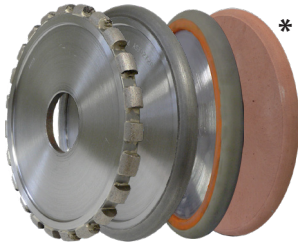

CODE	WIDTH	TYPE	REMOVAL	RPM	FEED
ASS02605	12	Segmented G1	to profile		1200-1500
ASF02620	12	Continuous G3	0.30 mm / 0.012"	2000-2500	mm/min 48-60 inches/min
ASF02630	12	Continuous G5	0.15 mm / 0.006"		
ASR02690 *	12	LUX Abrasive	0.03mm/mt 0.0012 inches/mt	2000-2500	1200 mm/min 48 inches/min
CSLG20012500B8	12	JOYLITE	0.00mm/0.00"		



Fitting available for Other Machine (Intermac, Breton, CMS, Prussiani, Omag, etc..)

DRAINBOARD GROOVE WHEELS Ø200x15 Radius 7.5 mm 50 mm bore

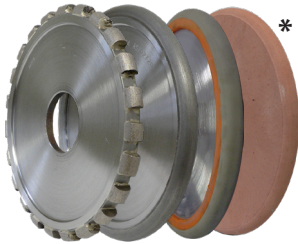

CODE	WIDTH	TYPE	REMOVAL	RPM	FEED
ASS02705	15	Segmented G1	to profile		1200-1500
ASF02720	15	Continuous G3	0.30 mm / 0.012"	2000-2500	mm/min 48-60 inches/min
ASF02730	15	Continuous G5	0.15 mm / 0.006"		
ASR02790 *	15	LUX Abrasive	0.03mm/mt 0.0012 inches/mt	2000-2500	1200 mm/min 48 inches/min
CSL00R75502008	15	JOYLITE	0.00mm/0.00"		



Fitting available for Other Machine (Intermac, Breton, CMS, Prussiani, Omag, etc..)

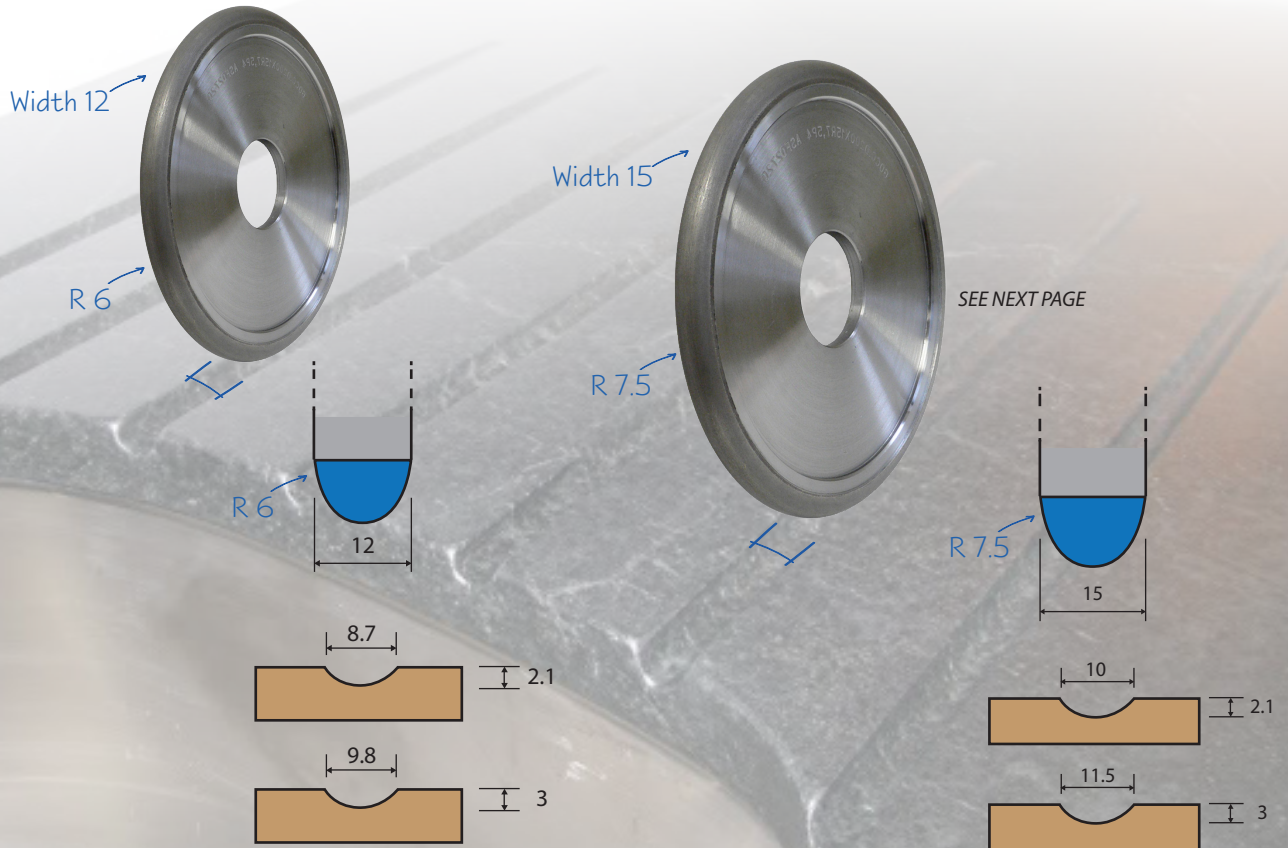

THE GROOVING WIDTH IS LESS THAN THE WHEELS WIDTH BECAUSE THE WORKING DEPTH IS NORMALLY 3-4mm LOWER THAN THE RADIUS OF THE WHEEL

DRAINBOARD GROOVE

kitchen top



DRAINBOARD GROOVE WHEELS Ø130x15 Radius 7.5
60 mm bore (30 mm bore for Breton)

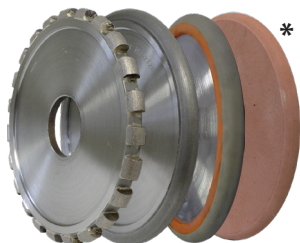

CODE	WIDTH	TYPE	REMOVAL	RPM	FEED
DSS3175S	15	Segmented G1	to profile	2000-2500	1200-1500 mm/min 48-60 inches/min
DSG31753	15	Continuous G3	0.30 mm / 0.012"		
DSG31754	15	Continuous G4	0.15 mm / 0.006"		
DSG31755	15	Continuous G5			
DSSF175S (**)	15	Segmented G1	to profile		
DSGF1753 (**)	15	Continuous G3	0.30 mm / 0.012"		
DSGF1754 (**)	15	Continuous G4	0.15 mm / 0.006"		
DSGF1755 (**)	15	Continuous G5			
DSR31751 *	15	LUX Abrasive	0.03mm/mt 0.0012 inches/mt	2000-2500	1200 mm/min 48 inches/min
CSL00R75601308	15	JOYLITE	0.00mm/0.00"		
DSR31751 *	15	LUX Abrasive			



DRAINBOARD GROOVE WHEELS Ø130x16 Radius 10
40 mm bore

NEW SHAPE "RIO" 



CODE	WIDTH	TYPE	REMOVAL	RPM	FEED
DSG68391	16	Continuous G1F	to profile	2000-2500	1200-1500 mm/min 48-60 inches/min
DSG68393	16	Continuous G3	0.30 mm / 0.012"		
DSG68395	16	Continuous G5	0.15 mm / 0.006"		
ASR02690 *	16	LUX Abrasive	0.03mm/mt 0.0012 inches/mt	2000-2500	1200 mm/min 48 inches/min
CSL00R10401307	16	JOYLITE			
CSL00R10401308	16	JOYLITE			

Fitting available for Other Machine (Intermac, Breton, CMS, Prussiani, Omag, etc..)

DRAINBOARD GROOVE WHEELS Ø150x16 Radius 10
40 mm bore for CMS

NEW SHAPE "RIO" 



CODE	WIDTH	TYPE	REMOVAL	RPM	FEED
DSG7110A	16	Continuous G1F	to profile	2000-2500	1200-1500 mm/min 48-60 inches/min
DSG71103	16	Continuous G3	0.30 mm / 0.012"		
DSG71105	16	Continuous G5	0.15 mm / 0.006"		
CLSG1501040166	16	JOYLITE	0.03mm/mt 0.0012 inches/mt	2000-2500	1200 mm/min 48 inches/min
CLSG1501040167	16	JOYLITE			

Fitting available for Other Machine (Intermac, Breton, CMS, Prussiani, Omag, etc..)

DRAINBOARD GROOVE WHEELS Ø150x12 Radius 5.5
40 mm bore



CODE	WIDTH	TYPE	REMOVAL	RPM	FEED
DSG7426A	12	Continuous G1F	to profile	2000-2500	1200-1500 mm/min 48-60 inches/min
DSG74263	12	Continuous G3	0.30 mm / 0.012"		
DSG74265	12	Continuous G5	0.15 mm / 0.006"		

Fitting available for Other Machine (Intermac, Breton, CMS, Prussiani, Omag, etc..)

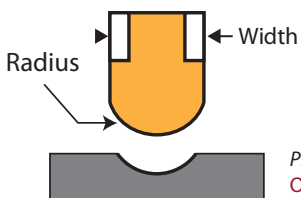

Please Note:
OMAG MACHINES NEED SPECIAL ADAPTERS



CONIC MILLS - WIDIA

10 mm Shank - For CARVING MARBLE (minimum order: 5 pcs)



CODE	SIZE	RPM	FEED
AFW60025	Ø10 x 5 mm - α30°	8000 - 10000	150 - 250 mm/min
AFW60027	Ø10 x 5 mm - α30° radius 1mm		
AFW70006	Ø10 x 5 mm - α60°		
AFW60010 ☺	Ø10 x 5 mm - α90°		
AFW61010	Ø10 x 5 mm - α105°		
AFW60031 ☺	Ø10 x 5 mm - α120°		
AFW60020	Ø15 x 7,5 mm - α90°		



CONIC MILLS - PCD (Polycrystalline Diamond)

10 mm Shank - For CARVING MARBLE & GRANITE

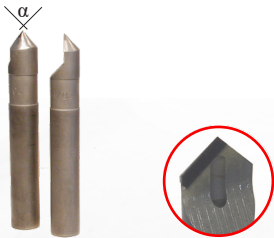

CODE	SIZE	RPM	FEED
AFW80010	Ø10 mm - α60°	8000 - 10000	150 - 250 mm/min
AFW80005 ☺	Ø10 mm - α90°		
AFW80004	Ø10 mm - α120°		
AFW80006	Ø15 mm - α90°		



ENGRAVING MILLS - Flat Head

Electroplated - 10 mm Shank - For ENGRAVING (minimum order: 5 pcs)

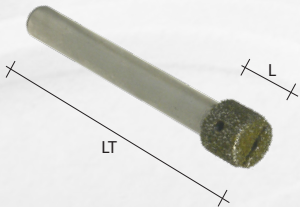

CODE	SIZE	RPM	FEED
AFE00030	Ø4 L12 LT90 mm	8000 - 10000	150 - 300 mm/min
AFE00035	Ø5 L12 LT90 mm		
AFE00040	Ø6 L12 LT90 mm		
EFE00036	Ø6 L20 LT90 mm		
AFE00060 *	Ø8 L12 LT90 mm		
AFE00024 *	Ø8 L20 LT140 mm		
EFE00245 *	Ø8 L25 LT70 mm		
AFE00065 *	Ø10 L12 LT90 mm		
EFE00030	Ø10 L30 LT100 mm		
EFE00248 *	Ø10 L35 LT85 mm		
EFE00220 *	Ø10 L40 LT90 mm		



* Internal cooling

ENGRAVING MILLS - Flat Head (no internal cooling)

Electroplated - 6 mm Shank - For ENGRAVING (minimum order: 5 pcs)

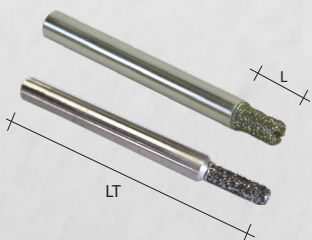

CODE	SIZE	RPM	FEED
AFE00005	Ø2 L10 LT80 mm	8000 - 10000	150 - 300 mm/min
AFE00011	Ø3 L12 LT60 mm		
AFE00016	Ø4 L12 LT60 mm		
AFE00021	Ø5 L12 LT60 mm		
AFE00026	Ø6 L12 LT60 mm		



☺ = ADVISED

ENGRAVING

engraving



ENGRAVING MILLS - Round Head (no internal cooling)
Electroplated - 6 mm Shank - For ENGRAVING (minimum order: 5 pcs)

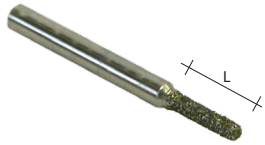

CODE	SIZE	RPM	FEED
AFE00010	Ø3 L15 LT60 mm	8000 - 10000	150 - 300 mm/min
AFE00015	Ø4 L15 LT60 mm		
AFE00020	Ø5 L15 LT60 mm		
AFE00025	Ø6 L15 LT60 mm		



CYLINDRICAL MILLS
F=1/2Gas

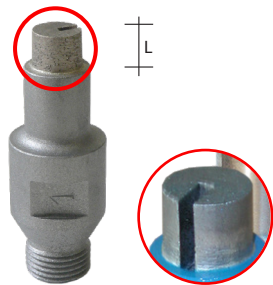

CODE	SIZE	RPM	FEED
AFF10005	Ø8 L12 mm	8000 - 10000	150 - 300 mm/min
AFF10010	Ø10 L12 mm		
AFF10015	Ø12 L12 mm		
AFF10020	Ø15 L12 mm		



NO-CORING DRILL BITS (use only to drill)
10 mm Shank

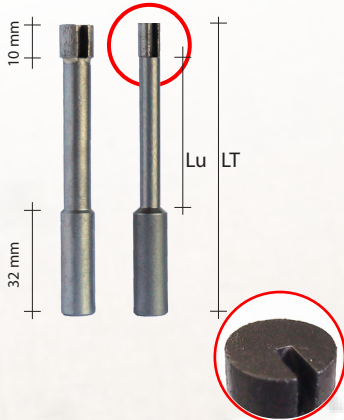

CODE	SIZE	RPM	FEED
ATS0210A	Ø4 LT62 Lu25 10/4	6200	25-30 mm/min
ATS0410A	Ø5 LT82 Lu25 10/4		
ATS0511B	Ø6 LT85 Lu45 10/5	6000	30-35 mm/min
ATS0612C	Ø6.5 LT85 Lu45 10/6		
ATS0712B	Ø7 LT85 Lu45 10/6	5800	25-30 mm/min
ATS0814C	Ø8 LT85 Lu45 10/8		
ATS1014C	Ø10 LT85 Lu45 10/8	5600	20-25 mm/min
ATS1215C	Ø12 LT85 Lu45 10/10		
ATS1515C	Ø15 LT85 Lu45 10/10	5500	



for 1/2 Gas see page C10

NO-CORING DRILL BITS HOLDER
Can also be used for T31



CODE	FITTING
AZT0572B	1/2 Gas > Bore 10 *
AZT0572A	1/2 Gas > Bore 12 *
AZT0614A	ADAPTER D12 ** > Bore 8
AZT0614B	ADAPTER D12 ** > Bore 6
AZT0614C	ADAPTER D12 ** > Bore 5
AZT0591A	M14 FEM > Bore 10
AZT0591B	M14 FEM > Bore 12





CONIC MILLS - Segmented

$F=1/2Gas$ - For ENGRAVING



CODE	SIZE	RPM	FEED
AFS50010	Ø8/14 L40 mm	7000 - 8000	150 - 300 mm/min
AFS50006 ☺	Ø14/20 L40 mm		
AFS50004	Ø22/28 L50 mm		



CONIC MILLS - Continuous Rim

$F=1/2Gas$ - For ENGRAVING



CODE	SIZE	RPM	FEED
DFG32111 ☺	Ø8/12 L20 mm	7000 - 8000	150 - 300 mm/min
DFG43191	Ø5/12 L20 mm		



CONIC MILLS - PCD

$F=1/2Gas$ - For ENGRAVING



CODE	SIZE	RPM	FEED
AFW90005	Ø3 Ld15 Lu55 mm	8000 - 10000	150 - 200 mm/min
AFW90006	Ø5 Ld15 Lu55 mm		

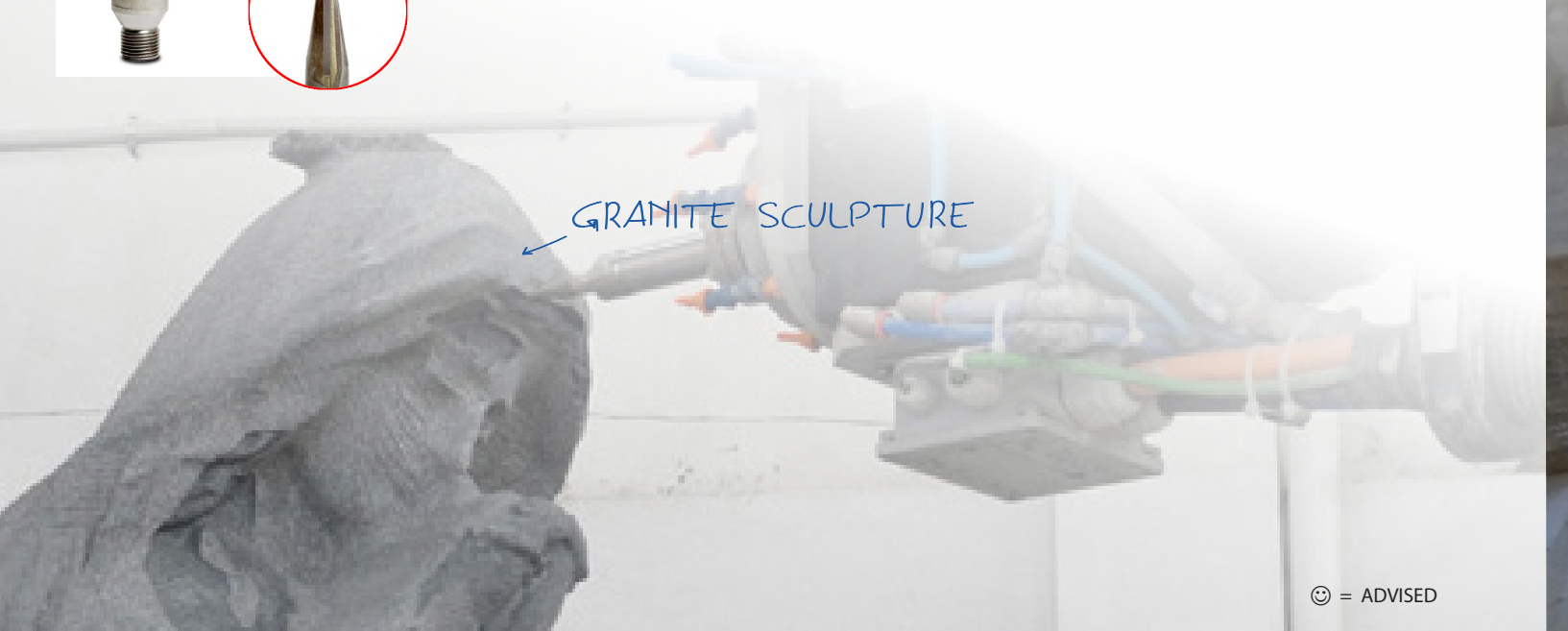

☺ = ADVISED

CONIC FINGERBITS & REPLACEABLE TIPS

sculpture



MAIN FINGERBITS - Conic (THREADED FOR THE ADDITION OF REPLACEABLE TIPS)

Electroplated - F=1/2Gas > M10 - For ENGRAVING



CODE	SIZE	RPM	FEED
AFE40020 ☺	Ø18/20 Ld15 Lu50 mm	6000 - 7000	400 - 800 mm/min
AFE40030	Ø18/20 Ld30 Lu50 mm		
AFE40060	Ø18/20 Ld60 Lu60 mm		
AFE40035 ☺	Ø18/20 Ld100 Lu100 mm		
AFE40025 ☺	Ø18/20 Ld150 Lu150 mm		



Watch the video on YouTube!



REPLACEABLE TIPS For Conic Main Fingerbits

Electroplated - F=M10 - For ROUGHING

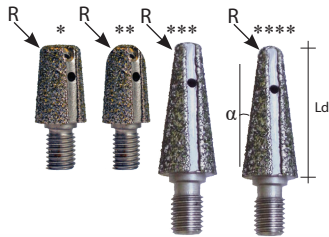

CODE	SIZE	α	GRIT	RPM	FEED
AFE42001* ☺	Ø14/18 Ld25 mm R=3mm	5°	D602		
AFE42002**	Ø14/18 Ld25 mm R=6mm	5°	D602		
AFE42009*** ☺ (note)	Ø10/18 Ld50 mm R=3mm	5°	D602	6000 - 7000	400 - 800 mm/min
AFE42015**** (note)	Ø10/18 Ld50 mm R=5mm	5°	D851		
AFE42016**** (note)	Ø5/18 Ld45 mm R=2.5mm	5°	D602		

note: minimum order 5 pcs



CONIC FINGERBITS

Electroplated - F=1/2Gas - For ROUGHING



CODE	SIZE	RPM	FEED
AFE30005	Ø8/14 L40 mm Lu40 R3		
AFE30010	Ø14/20 L40 mm Lu40 R3		
AFE30018	Ø14/20 L40 mm Lu70 R3	6000 - 7000	400 - 800 mm/min
AFE30020	Ø14/20 L40 mm Lu100 R3		
AFE30025	Ø14/20 L40 mm Lu120 R3		



MARBLE SCULPTURE

☺ = ADVISED



CONIC MILLS - WIDIA 1/2 Gas - For FINISHING

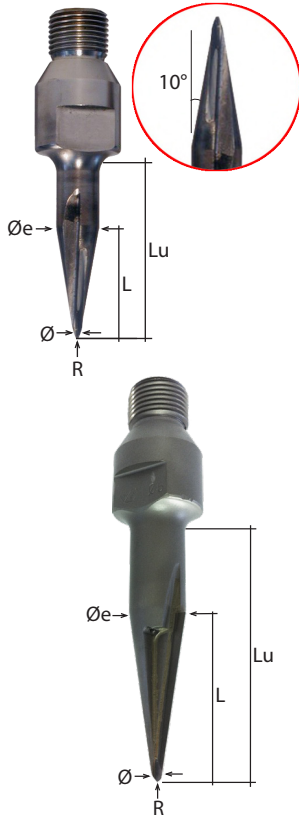

CODE	Ø	Øe	R	L	Lu	RPM	FEED
AFW50005 ☺	3	15	1.5	30	60	8000	150 mm/min
AFW50010	5	15	2.5	30	60		
AFW50015 ☺	5	22	2.5	50	85		
AFW50020	8	15	4	30	60		
AFW50025	8	22	4	50	85		
AFW50026	8	22	4	50	110		
AFW50040	3	22	1.5	50	85		
AFW50045	3	22	1.5	50	110		
EFW00001 ☺	3	15	1.5	30	115		
EFW00010	5	15	2.5	30	115		
EFW00012 ☺	5	22	2.5	50	115		
EFW00015 note*	8	15	4	30	115		
EFW00025 note*	3	15	1.5	30	170		
EFW00030 note*	3	22	1.5	50	170		
EFW00035 note*	5	22	2.5	44	140		



NOTE*: SPECIAL TOOLS. Only available upon request (long delivery)



Watch the video
on YouTube !

CONIC MILLS - WIDIA 1/2 Gas - For FINISHING

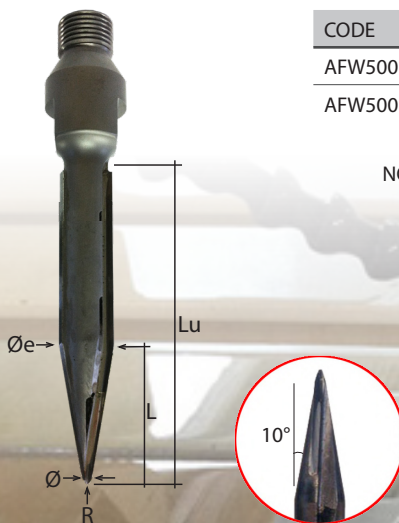

CODE	Ø	Øe	R	L	Lu	RPM	FEED
AFW50070 note*	3	19	1.5	44	125	8000	150 mm/min
AFW50075 ☺ note*	5	19	2.5	44	125		



NOTE*: SPECIAL TOOLS. Only available upon request (long delivery)



☺ = ADVISED

HEAVY METAL CONIC MILLS

sculpture



CONIC MILLS - WIDIA 1/2 Gas - For FINISHING

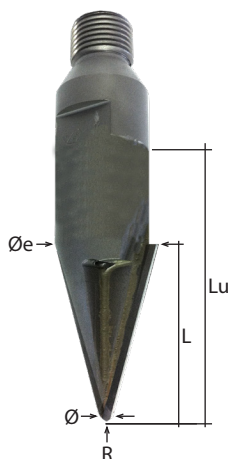

CODE	Ø	Øe	R	L	Lu	RPM	FEED
EFW00055 note*	5	35	2.5	87	140	8000	150 mm/min
EFW00060 note*	4	35	2	90	119		
EFW00063 note*	3	30	1.5	65	115		



NOTE*: SPECIAL TOOLS. Only available upon request (long delivery)



CONIC MILL - HARD METAL TG6* 1/2 Gas - For FINISHING



CODE	Ø	Øe	R	L	Lu	RPM	FEED
AFW40350	5	12	2.5	48	50	8000	150 mm/min
AFW40370 ☺	5	16	2.5	80	103		
AFW40380 ☺	8	20	4	102	125		
AFW40365 ☺	2	12	1	28	43		
AFW40355	6	12	3	28	43		
AFW40375	5	16	2.5	35	55		
AFW40360	11	20	5.5	40	55		



TG6* is perfect for use with soft marble.
On request are available TG4 for cutting hard marble.



Watch the video
on YouTube !



☺ = ADVISED



CUTTING FINGERBITS

Electroplated - F=1/2Gas

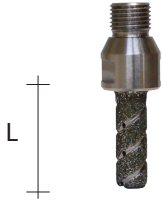

CODE	SIZE	RPM	FEED
AFE80005	Ø16 x 30 mm	4800-5500	250-500 mm/min
AFE80010 ☺	Ø16 x 40 mm		
AFE80015	Ø16 x 50 mm		



CUTTING FINGERBITS

Electroplated - F=1/2Gas



CODE	SIZE	RPM	FEED
AFE80027 ☺	Ø20 x 60 mm	4800-5500	250-500 mm/min
AFE80030	Ø20 x 70 mm		
AFE80034	Ø20 x 80 mm		
AFE80037	Ø20 x 100 mm		
AFE80055 ☺	Ø23 x 105 mm		



CUTTING FINGERBITS

Segmented - Flange Connection

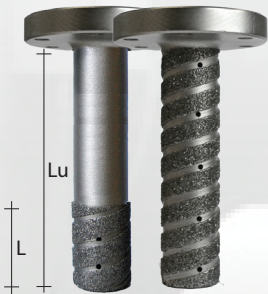

CODE	SIZE	RPM	FEED
EFE00085	Ø20 x 210 mm	4500-5200	250-500 mm/min
EFE00034	Ø30 x 115 mm		10-20 inches/min
EFE00144	Ø30 x 215 mm		
DFE3185E	Ø20 x 50 Lu185 mm		
DFE1642A	Ø30 x 30 Lu280 mm		
EFE00023	Ø30 x 50 Lu200 mm		
DFE3075D	Ø30 x 60 Lu340 mm		



CUTTING FINGERBITS

Electroplated - F=1/2Gas



CODE	SIZE	RPM	FEED
AFE81005	Ø23 x 40 Lu85 mm	4800-5500	250-500 mm/min
AFE81010 ☺	Ø23 x 40 Lu105 mm		
AFE81015 ☺	Ø23 x 40 Lu125 mm		
AFE81020	Ø23 x 40 Lu155 mm		
AFE81030	Ø23 x 40 Lu205 mm		



☺ = ADVISED

CUTTING FINGERBITS - ELECTROPLATED

special works



CUTTING MAIN FINGERBITS - THREADED FOR THE ADDITION OF REPLACEABLE TIPS

Electroplated - F=1/2Gas



CODE	SIZE	FITTING	RPM	FEED
EFE00176	Ø20 x 40 mm	M12 FEMALE	4500-5200	250-500 mm/min 10-20 inches/min
EFE00183 ☺	Ø20 x 50 mm	M12 FEMALE		
EFE00164	Ø20 x 60 mm	M12 FEMALE		
DFE35850	Ø20 x 80 mm	M12 FEMALE		
DFE45861	Ø25 x 130 mm	M12 FEMALE		



Watch the video on YouTube !

CUTTING MAIN FINGERBITS - THREADED FOR THE ADDITION OF REPLACEABLE TIPS

Electroplated - F=1/2Gas

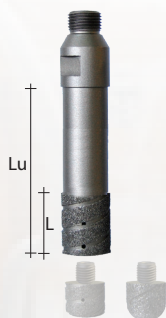

CODE	SIZE	FITTING	RPM	FEED
EFE00200 ☺	Ø25 L40 Lu130	M12 FEMALE	4500-5200	250-500 mm/min 10-20 inches/min
EFE00201	Ø30 L40 Lu150	M14 FEMALE		



CUTTING MAIN FINGERBITS - THREADED FOR THE ADDITION OF REPLACEABLE TIPS

Electroplated - Flange Connection



CODE	SIZE	FITTING	RPM	FEED
DFE45821	Ø30 x 230 mm	M14 FEMALE	4500-5200	250-500 mm/min 10-20 inches/min
EFE00202	Ø30 x 40 Lu150	M14 FEMALE		



REPLACEABLE TIPS

Electroplated



CODE	SIZE	FITTING	RPM	FEED
EFE00165 **	Ø20 x 22 mm	M12	4500-5200	250-500 mm/min 10-20 inches/min
EFE00199 **	Ø30 x 30 mm	M14		
EFE00184 * ☺	Ø20 x 20 mm	M12		
DFE36552 *	Ø25 x 25 mm	M12		
DFE2831C *	Ø30 x 25 mm	M14		





SPHERIC MILLS

Electroplated - $F=1/2Gas$

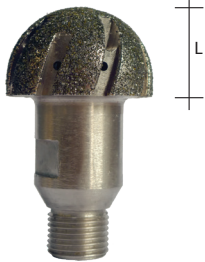

CODE	SIZE	GRIT	RPM	FEED
AFE60005	Ø30 L20 mm	D1	5000-5500	200-400 mm/min
AFE60010	Ø30 L20 mm	D2		
AFE60015	Ø40 L25 mm	D1		
AFE60020	Ø40 L25 mm	D2		
AFE60025	Ø50 L30 mm	D1		
AFE60030	Ø50 L30 mm	D2		



SPHERIC MILLS

Segmented - $F=1/2Gas$

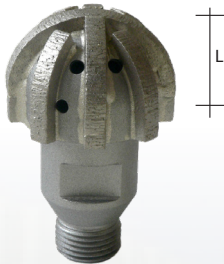

CODE	SIZE	GRIT	RPM	FEED
AFS60005	Ø30 L20 mm	G1	4500-5000	200-400 mm/min
AFS60010	Ø30 L20 mm	G3		
AFS60015	Ø40 L25 mm	G1		
AFS60020	Ø40 L25 mm	G3		
AFS60025	Ø50 L30 mm	G1		
AFS60030	Ø50 L30 mm	G3		



INCREMENTAL CUTTING

special works

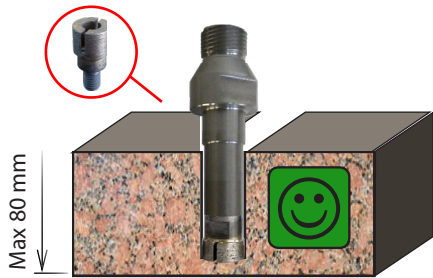

1. CROWN MILL Ø20
 Cut from 30 to 80 mm
 RPM: 4200 - 4800
 Feed: 800 - 200 mm/min
 Each Step: 2 - 3 mm

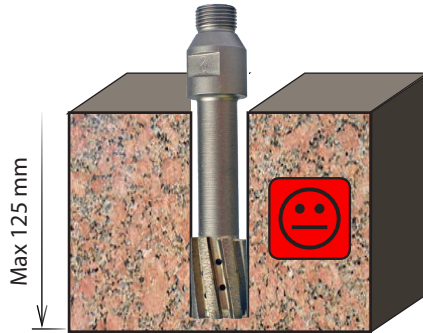

2. STEP CUTTER
 Cut from 50 to 125 mm
 RPM: 4800 - 5500
 Feed: 800 - 200 mm/min
 Each Step: 20 - 30 mm

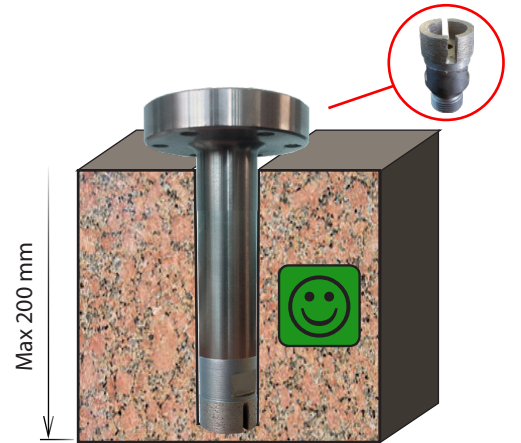

3. CROWN MILL Ø30
 Cut from 60 to 200 mm
 RPM: 4200 - 4800
 Feed: 250 - 500 mm/min
 Each Step: 1 - 3 mm

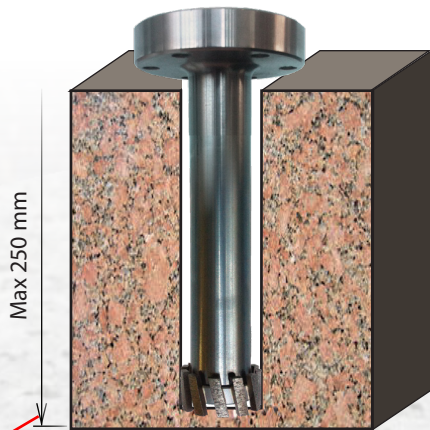

4. Ø40 STUBBING WHEEL
 Cut from 100 to 250 mm
 RPM: 4800 - 5500
 Feed: 250 - 500 mm/min
 Each Step: 2 - 4 mm

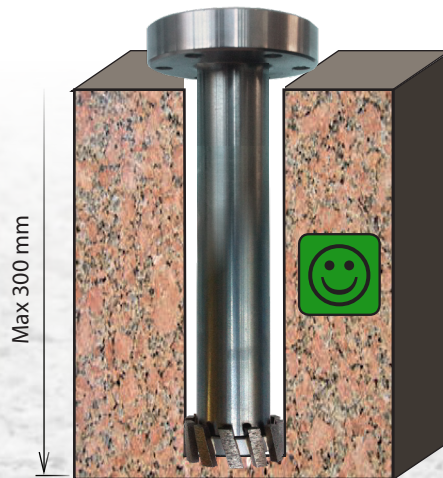

5. Ø50 STUBBING WHEEL
 Cut from 100 to 300 mm
 RPM: 4500 - 5000
 Feed: 250 - 500 mm/min
 Each Step: 2 - 4 mm



1. USE CROWN MILL Ø20 TO CUT 30 - 80 mm
2. USE STEP CUTTER TO CUT 50 - 125 mm
3. USE CROWN MILL Ø30 TO CUT 60 - 200 mm
4. USE Ø40 STUBBING WHEEL TO CUT 100 - 250 mm
5. USE Ø50 STUBBING WHEEL TO CUT 100 - 300 mm

☺ = ADVISED



Ø20 CROWN MILLS

SEGMENTED for Incremental Cutting and Flush Fit minimum radius 10 mm



CODE	SIZE	FITTING	MATERIAL	RPM	FEED
CFS4C077 ☺	Ø20 x 13 mm	M12	GR. & E.S.	4800-5500	400 - 1000 mm/min 18 - 40 inches/min x 3mm deep
CFS4C042	Ø20 x 13 mm	M10	GR. & E.S.		
CFS4C086	Ø20 x 13 mm	M14	GR. & E.S.		
AFS40075	Ø15 x 20 mm	1/2 GAS	GR. & E.S.		
CFS40031	Ø10 x 10 mm	1/2 GAS	GR. & E.S.		
CFS40031CER	Ø10 x 10 mm	1/2 GAS	CERAMICS		
CFS40032CER	Ø12 x 10 mm	1/2 GAS	CERAMICS		
CFS4C078	Ø20 x 10 mm	M12	CERAMICS		
CFS40073CER	Ø20 x 12 mm	1/2 GAS	CERAMICS		



See page A92 for LEFT THREADED crown mills

Ø20 CROWN MILLS

Electroplated - For Incremental Cutting



CODE	SIZE	FITTING	RPM	FEED
AFE41010	Ø20 x 10 mm	M10	4200 - 4800	800 - 2000 mm/min x 3mm deep
AFE41020 ☺	Ø20 x 10 mm	M12		



See page A92 for LEFT THREADED crown mills

TOOL HOLDER For Ø20 CROWN MILLS

1/2 Gas > M10/M12

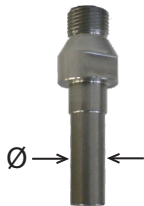

CODE	SIZE	FITTING TOOLS	FITTING MACHINE
AZT1518G	Ø17 x 30 mm	M10	1/2 Gas
AZT1518E ☺	Ø17 x 30 mm	M12	1/2 Gas
AZT1518B	Ø17 x 60 mm	M10	1/2 Gas
AZT1518A ☺	Ø17 x 60 mm	M12	1/2 Gas
AZT1518F	Ø18 x 100 mm	M12	1/2 Gas
AZT1518T	Ø18 x 120 mm	M12	1/2 Gas

Ø30 CROWN MILLS

For Incremental Cutting



CODE	SIZE	FITTING	RPM	FEED
DFS3705S ☺	Ø30 x 15 mm	1/2 Gas	4200 - 4800	800 - 2000 mm/min
DFS5574C	Ø30 x 15 mm	M14		
DFS5033C	Ø30 x 15 mm	M16		



See page A92 for LEFT THREADED crown mills

Ø30 CROWN MILL

Electroplated - For Incremental Cutting



CODE	SIZE	FITTING	RPM	FEED
DFE4628E	Ø30 x 20 mm	1/2 Gas	4200 - 4800	800 - 2000 mm/min



☺ = ADVISED

INCREMENTAL CUTTING

special works



CUTTING FINGERBITS

Segmented - For Incremental Cutting



CODE	SIZE	FITTING	RPM	FEED
AFS91083	Ø23 x 40 / Z5 FB3	1/2 Gas	4800-5500	250-500 mm/min 10-20 inches/min
AFS91082	Ø23 x 40 / Z5 FB2	1/2 Gas		
AFS91085	Ø23 x 50 / Z5 FB3	1/2 Gas		
AFS91084	Ø23 x 50 / Z5 FB2	1/2 Gas		



CUTTING FINGERBITS

Segmented - For Incremental Cutting - NOT SUGGESTED TO WORK LONGER THAN 95mm



CODE	SIZE	FITTING	RPM	FEED
AFS90000	Ø23 L25 LT40	1/2 Gas	4800-5500	250-500 mm/min 10-20 inches/min
AFS90080	Ø30 L30 LT40	1/2 Gas		
AFS90065 ☺	Ø28 L40 LT95	1/2 Gas		
AFS90066 ☹	Ø28 L40 LT105	1/2 Gas		
AFS90067 ☹	Ø28 L40 LT125	1/2 Gas		



TOOL HOLDERS For Ø30 CROWN MILLS

Flange > 1/2 Gas

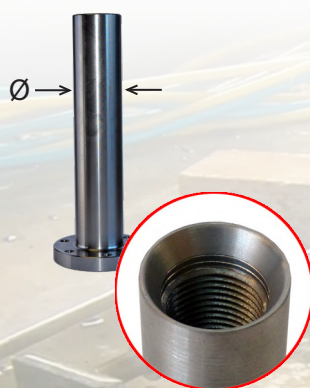

CODE	SIZE	FITTING TOOLS	FITTING MACHINE
AZT0587A	Ø28 x 100 mm	1/2 Gas (female)	B50+6HØ6.5/63
AZT0588A	Ø28 x 150 mm	1/2 Gas (female)	B50+6HØ6.5/63
AZT0589A ☺	Ø28 x 200 mm	1/2 Gas (female)	B50+6HØ6.5/63
AZT0590A	Ø28 x 250 mm	1/2 Gas (female)	B50+6HØ6.5/63
AZT4917A	Ø28 x 300 mm	1/2 Gas (female)	B50+6HØ6.5/63

DFS3705S
Ø30 CROWN MILL



☺ = ADVISED



STUBBING WHEELS - TURBO

Normal diameter



CODE	SIZE	FITTING	RPM	FEED
AMC00054	Ø50 x 20 mm	B14 - 3+3	4500-5000	250-500 mm/min 10-20 inches/min
AMC00055 ☺	Ø50 x 20 mm	B10 - 2+2		
AMC00056	Ø50 x 20 mm	B14 - 3+3	4500-5000	250-500 mm/min 10-20 inches/min
AMC00057 ☺	Ø50 x 20 mm	B10 - 2+2		



STUBBING WHEELS

Segmented - Small diameter



AMS00178
NEW!



CODE	SIZE	FITTING	RPM	FEED
EMS00143	Ø53 x 20 mm	B14 - 3+3	4500-5000	250-500 mm/min 10-20 inches/min
AMS00020 ☺	Ø50 x 20 mm	B10 - 2+2		
EMS00095	Ø50 x 20 mm	B14 - 3+3		
AMS00178 ☺	Ø53 x 30 mm	B10 - 2+2		
AMS00021	Ø53 x 20 mm	B10 - 2+2		
EMS00011	Ø46 x 20 mm	B14 - 3+3		



AMS00002 ☺	Ø40 x 20 mm	B8.5 TSEI +2B	4800-5500	250-500 mm/min 10-20 inches/min
------------	-------------	---------------	-----------	------------------------------------

STUBBING WHEELS

Electroplated - Small diameter

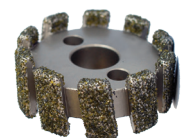
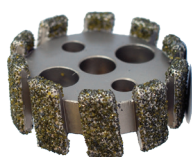

CODE	SIZE	FITTING	RPM	FEED
AME00020 ☺	Ø50 x 20 mm	B10 - 2+2	4500-5000	250-500 mm/min 10-20 inches/min
AME00028	Ø50 x 20 mm	B14 - 3+3		



AME00015 ☺	Ø40 x 20 mm	B8.5 TSEI +2B	4800-5500	250-500 mm/min 10-20 inches/min
------------	-------------	---------------	-----------	------------------------------------

☺ = ADVISED

STUBBING WHEELS

special works



STUBBING WHEELS

Segmented - Small Diameter - F=1/2Gas



CODE	SIZE	FITTING	RPM	FEED
DFS4628S	Ø30 x 20 mm	1/2 Gas	5500-6500	400-500 mm/min
DFS4831S	Ø40 x 25 mm	1/2 Gas		
DFS4831X	Ø40 x 25 mm	1/2 Gas LT		



LT = Left Thread



STUBBING WHEELS

Electroplated - Small Diameter - F=1/2Gas



CODE	SIZE	FITTING	RPM	FEED
DFE4831E	Ø40 x 25 mm	1/2 Gas	5500-6500	400-500 mm/min
DFE4628E ☺	Ø30 x 20 mm	1/2 Gas		



STUBBING WHEELS - CONCAVE

Segmented



CODE	SIZE	FITTING	RPM	FEED
DSS5348S	Ø50 x 23 mm	Ø10+2 holes	5500-6500	400-500 mm/min
DSS5455S	Ø85 x 23 mm	Ø50+3 holes		



STUBBING WHEELS - CONCAVE

Electroplated



CODE	SIZE	FITTING	RPM	FEED
DSE1612E ☺	Ø50 x 20 mm	Ø10+2 holes	5500-6500	400-500 mm/min
DSE4343D	Ø85 x 20 mm	Ø50+6 holes		
DSE3649D	Ø100 x 20 mm	Ø50+6 holes		
DSE5455D	Ø85 x 23 mm	Ø50+3 holes		



STUBBING WHEELS - REINFORCED

Segmented

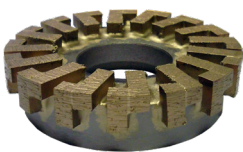

CODE	SIZE	FITTING	RPM	FEED
DSS5444G	Ø53 x 24 mm	Ø10+2 holes	5500-6500	400-500 mm/min
DSS5445G	Ø88 x 24 mm	Ø50+6 holes		
DFS5593S	Ø30 x 20 mm	1/2 Gas		
DFS5594S	Ø50 x 20 mm	1/2 Gas		



☺ = ADVISED



BLADES - HORIZONTAL

Electroplated Both Side are Reinforced - F50+6 Holes



CODE	SIZE	REINFORCES	PRM	FEED
ADE20035	Ø201 x 3.5 mm	6+6 L20	2400-2800	1200-2800 mm/min.
ADE20235 ☺	Ø241 x 4.5 mm	8+8 L30	2400-2800	
DME3395C	Ø290 x 4 mm	9+9 L60	2200-2500	48-60 inches/mm
EDE00012 *	Ø340 x 4 mm	6+6 L30	2000-2400	

Available w/ Countersunk Holes or Cylindrical Holes

* USE ONLY WITH BIGGER FLANGE CONE (see below)

LOCKING FLANGE for BLADES

Both Side are Reinforced - B50+6 Holes



CODE	SIZE	FITTING
AZT2765A	Ø77 mm	D50 +6H

EXTENSIONS

For Horizontal Blades (max diameter 300mm)



CODE	SIZE	FITTING
AZT0583A	Ø45 L100 mm	from FLANGE (B50+6H) to FLANGE (D50+6 M6)
AZT0584A	Ø45 L133 mm	from FLANGE (B50+6H) to FLANGE (D50+6 M6)
AZT0734A ☺	Ø45 L207 mm	from FLANGE (B50+6H) to FLANGE (D50+6 M6)
AZT2501A	Ø45 L300 mm	from FLANGE (B50+6H) to FLANGE (D50+6 M6)
AZT0566A	Ø72 mm	from 1/2 GAS to FLANGE (D50+6H)



Watch the video on YouTube !

← Ø150 mm

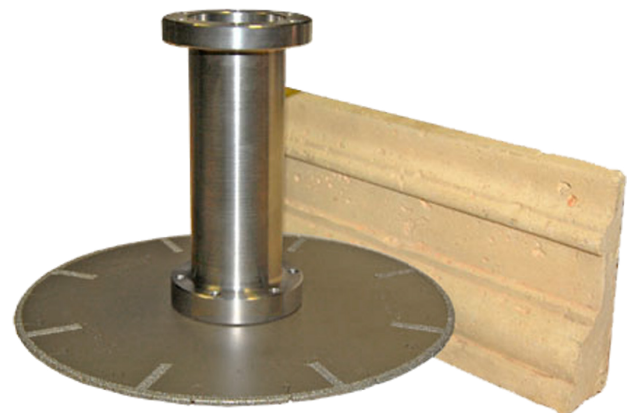

max diameter 300mm

above D300 (12") diameter, blades need to be used with a flange cone.

for standard and reinforced blades see pages D2, D3 & D4

KIT FOR POLISHING (not for flat surfaces)

special works



GENERATING WHEEL

For Profiling



CODE	SIZE	FITTING	PRM	FEED
ACF8FL4S	Ø100 x 30 mm	Flange	4000 - 4500	500-1000 mm/min



FITTING FLANGE FOR PADS

For Profiling



CODE	SIZE	FITTING
AZT3673A	Ø100 mm - 4"	Flange > M14
AZZ00197	Ø100 mm - 4"	Velcro > M14

POLISHING PADS - DIAHARD (for Wet Use)

D100 mm w/ Velcro back

CODE	DIAMETER	GRIT
CCR63005	100 mm 4 inches	#1
CCR63010		#2
CCR63015		#3
CCR63020		#4
CCR63025		#5
CCR63030		#6

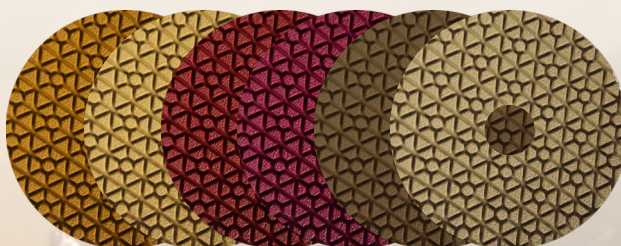



CORE BIT - Segmented

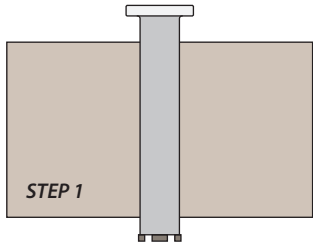

CORE BIT - Electroplated

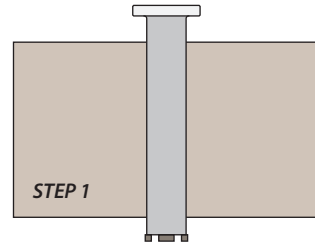

STUBBING WHEEL - Segmented

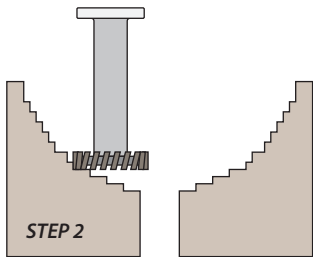

STUBBING WHEEL - Electroplated

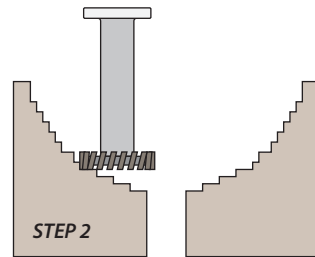

COARSE HEAD MILL - Segmented Coarse

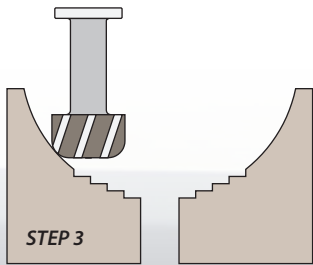

COARSE HEAD MILL - Electroplated

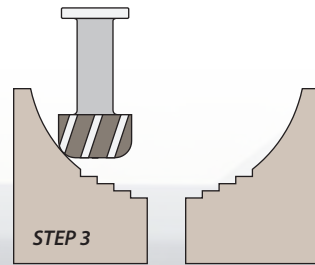

FINE HEAD MILL - Segmented Fine

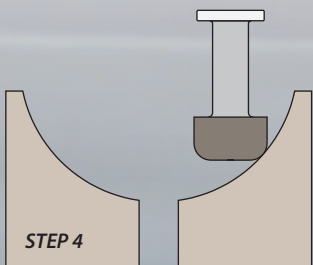

FINE HEAD MILL - Electroplated

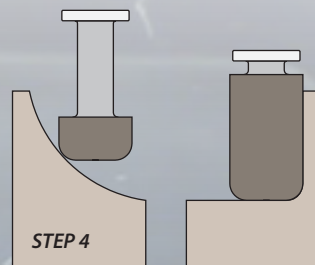

HEAD MILL - JoyLite

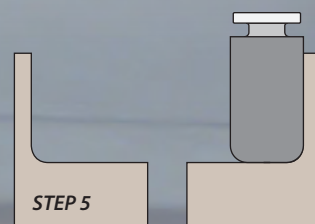

GRANITE SINKS

sinks



CORE BITS - SEGMENTED

Step 1

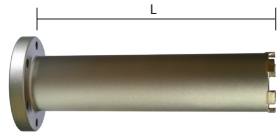

CODE	SIZE	RPM	FEED	DISTANCE
APS4E050	Ø50 L170 mm	2000-2500	60-120 mm/min	to drill initial hole
APS4F050	Ø50 L200 mm			
APS4H050	Ø50 L250 mm			
APS4E090	Ø90 L170 mm	1000-1500	2.4-4.8 inches/min	
APS4F090	Ø90 L200 mm			
APS4H090	Ø90 L250 mm			



STUBBING WHEELS - SEGMENTED

Step 2



CODE	SIZE	RPM	FEED	DISTANCE
AMS00089	Ø88 x 20 mm	4300-5000	300-600 mm/min 12-24 inches/min	3-6 mm 0.12-0.24"



EXTENSION FLANGES FOR ROUND HEAD MILL

For other sizes see at page A84

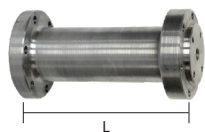

CODE	SIZE	CODE	SIZE
AZT0584A	Ø45 L133 mm	AZT2501A	Ø45 L300 mm
AZT0734A	Ø45 L207 mm	AZT3753A	Ø45 L400 mm

ROUND HEAD MILLS - SEGMENTED

Step 3-4

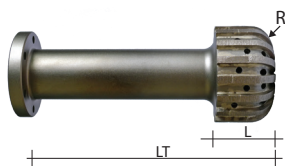

CODE	SIZE	RPM	FEED	DISTANCE
AFS70025	Ø85 R20 L50 LT177*	4500-4800	600-1000mm/ min 24-40 inches/min	1-5 mm 0.04-0.20"
AFS70030	Ø85 R20 L50 LT177**			
AFS70026	Ø85 R20 L50 LT225*	4500-4800	600-1000mm/ min 24-40 inches/min	1-5 mm 0.04-0.20"
AFS70031	Ø85 R20 L50 LT225**			



* COARSE ** MEDIUM

ROUND HEAD MILLS - SEGMENTED

Step 3-4

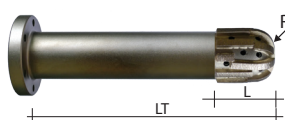

CODE	SIZE	RPM	FEED	DISTANCE
AFS70005	Ø50 R20 L50 LT177*	4500-4800	600-1000mm/ min 24-40 inches/min	1-5 mm 0.04-0.20"
AFS70010	Ø50 R20 L50 LT177**			
AFS70015	Ø50 R20 L50 LT225*	4500-4800	600-1000mm/ min 24-40 inches/min	1-5 mm 0.04-0.20"
AFS70020	Ø50 R20 L50 LT225**			



* COARSE ** MEDIUM



CORE BITS - ELECTROPLATED

Step 1



CODE	SIZE	RPM	FEED	DISTANCE
APE43049	Ø50 L170 mm	2000-2500	60-120 mm/min 2.4-4.8 inches/ min	to drill initial hole
APE43050	Ø50 L200 mm			
APE4i050	Ø50 L250 mm			
APE50080	Ø90 L170 mm	1000-1500		
APE50090	Ø90 L200 mm			
APE4i090	Ø90 L250 mm			



STUBBING WHEEL - ELECTROPLATED

Step 2



CODE	SIZE	RPM	FEED	DISTANCE
AME00030	Ø85 x 20 mm	5000-5300	500-600 mm/min 20-24 inches/min	3-6 mm 0.12-0.24"



EXTENSIONS FOR ROUND HEAD MILLS

For other sizes see at page A84

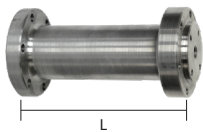

CODE	SIZE	CODE	SIZE
AZT0584A	Ø45 L133 mm	AZT2501A	Ø45 L300 mm
AZT0734A	Ø45 L207 mm	AZT3753A	Ø45 L400 mm



ROUND HEAD MILLS - ELECTROPLATED

Step 3-4

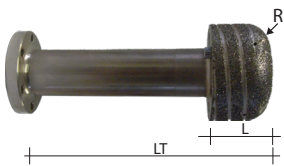

CODE	SIZE	GRIT	RPM	FEED	DISTANCE
AFE70015	Ø85 R20 L50 LT177	C	5000-6000	800-1000mm/min 32-40 inches/min	1-5 mm
AFE70020	Ø85 R20 L50 LT177	M			0.04-0.20"
AFE70025	Ø85 R20 L50 LT225	C			
AFE70030	Ø85 R20 L50 LT225	M			



BALL HEAD MILLS - ELECTROPLATED

Step 3-4

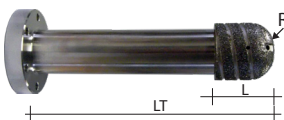

CODE	SIZE	GRIT	RPM	FEED	DISTANCE
AFE70005	Ø50 R20 L50 LT177	C	5000-6000	800-1000mm/ min 32-40 inches/min	1-5 mm
AFE70010	Ø50 R20 L50 LT177	M			0.04-0.20"
AFE70013	Ø50 R20 L50 LT225	C			
AFE70014	Ø50 R20 L50 LT225	M			



MARBLE SINKS

sinks



ROUND HEAD MILL - ELECTROPLATED for RECTIFYING

Step 4

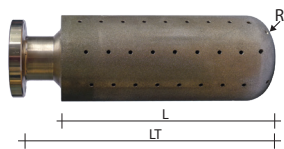

CODE	SIZE	GRIT	RPM	FEED	DISTANCE
DFE2980A	Ø85 R20 L200 LT250	F	5000-6000	800-1000	1-5 mm
DFE2980B	Ø85 R20 L200 LT250	M		mm/min	0.04-0.20"



BALL HEAD MILLS - JOYLITE

Step 5



CODE	SIZE	RPM	FEED	DISTANCE
CSLTS180235706	Ø70 R20 L180 *	2000-2500	400-500mm/min	
CSLTS180235707	Ø70 R20 L180 **		15-20 inches/min	
CSLTS180235708	Ø70 R20 L180 ***			

* G6 ** G7 *** G8

ADAPTER FOR JOYLITE BALL HEAD MILLS

Flanged Adapter



CODE	SIZE
AZT0582D	D35X150 mm

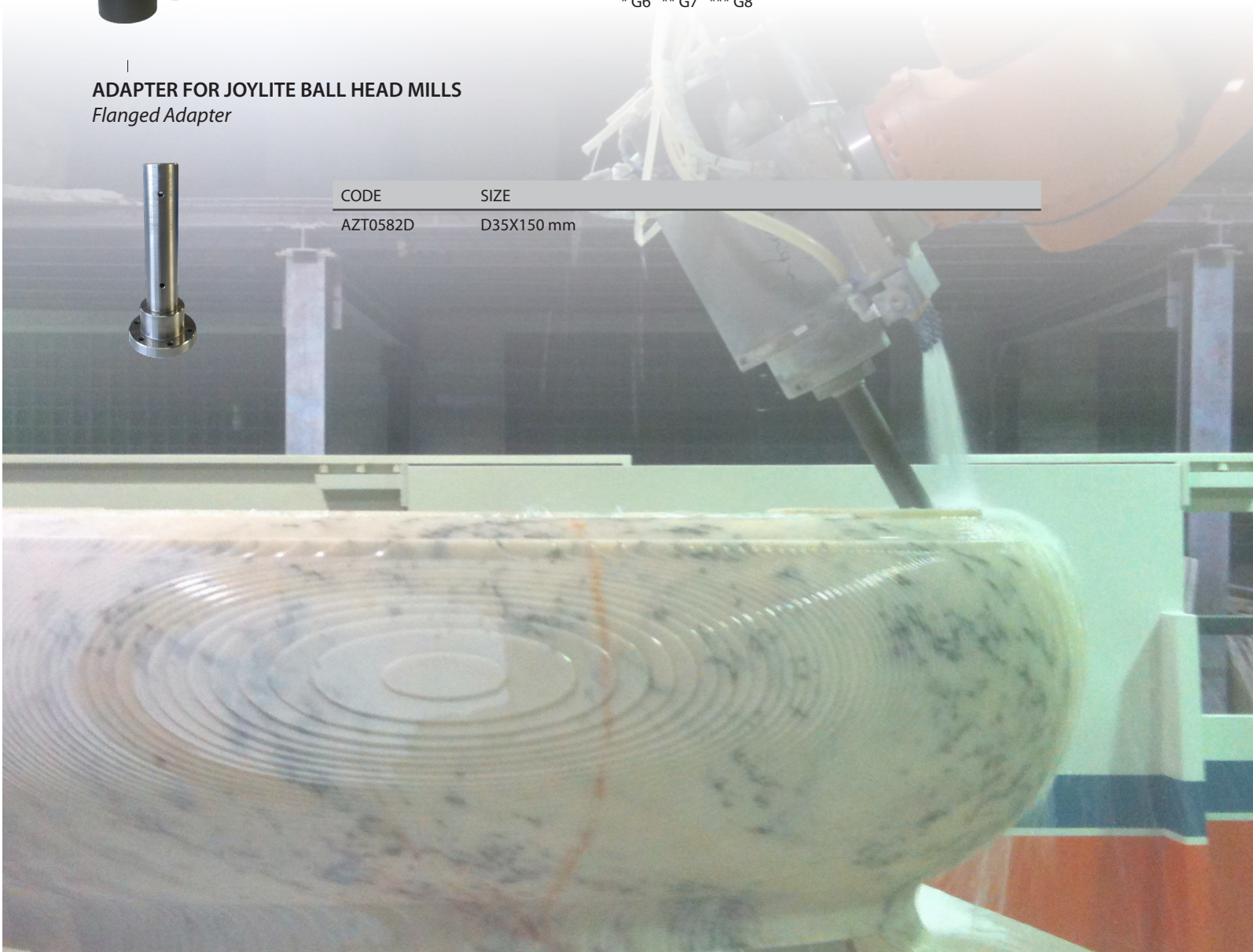

REPLACEABLE HEAD MILLS

sinks



ROUND HEAD MILLS - SEGMENTED (REPLACEABLE)

B50+6H Ø6.5/63



GRIT	CODE	SIZE	FITTING	EXTENSION	
P1	DFS3382S	Ø85 R20 L50 mm	B50+6HØ6.5/63	A	B
P3	DFS33823	Ø85 R20 L50 mm	B50+6HØ6.5/63	A	B



ROUND HEAD MILLS - ELECTROPLATED (REPLACEABLE)

B50+6H Ø6.5/63



GRIT	CODE	SIZE	FITTING	EXTENSION	
D602	DFE3382D	Ø85 R20 L50 mm	B50+6HØ6.5/63	A	B
D107	DFE3382B	Ø85 R20 L50 mm	B50+6HØ6.5/63	A	B



ROUND HEAD MILLS - ELECTROPLATED (REPLACEABLE)

M24x2 FEM



GRIT	CODE	SIZE	FITTING	EXTENSION	
D602	DFE5172D	Ø50 R20 L50 mm	M24x2 FEM	C	
D107	DFE5172B	Ø50 R20 L50 mm	M24x2 FEM	C	



ROUND HEAD MILLS - SEGMENTED (REPLACEABLE)

B=35



GRIT	CODE	SIZE	FITTING	EXTENSION	
P1	DFS4948S	Ø85 R25 L60 mm	B=35	D	E
P3	DFS49483	Ø85 R25 L60 mm	B=35	D	E



ROUND HEAD MILLS - SEGMENTED (REPLACEABLE)

B50+6H Ø6.5/63



GRIT	CODE	SIZE	FITTING	EXTENSION	
P1	DFS4677S	Ø85 R25 L60 mm	B50+6HØ6.5/63	A	B
P3	DFS46773	Ø85 R25 L60 mm	B50+6HØ6.5/63	A	B



ROUND HEAD MILLS - ELECTROPLATED (REPLACEABLE)

B=35



GRIT	CODE	SIZE	FITTING	EXTENSION	
D602	DFE4948D	Ø85 R25 L60 mm	B=35	D	E
D107	DFE4948B	Ø85 R25 L60 mm	B=35	D	E



EXTENSIONS / ADAPTORS / TOOLHOLDERS

sinks



EXTENSIONS FLANGE > FLANGE

For Replaceable Round Heads

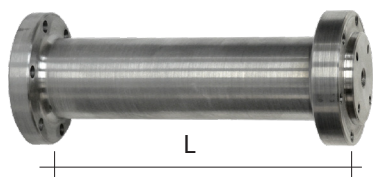

REF	CODE	SIZE	FITTING MACHINE	FITTING TOOL
A	AZT0583A	Ø45 L100 mm	B50+6HØ6.5/63	Ø50+6M6/63
A	AZT0584A	Ø45 L133 mm	B50+6HØ6.5/63	Ø50+6M6/63
A	AZT0734A	Ø45 L207 mm	B50+6HØ6.5/63	Ø50+6M6/63
A	AZT2501A	Ø45 L300 mm	B50+6HØ6.5/63	Ø50+6M6/63

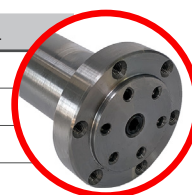

FITTING M30 > FLANGE

For Replaceable Round Heads

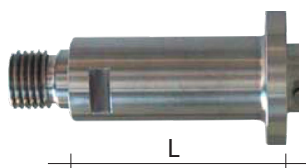

REF	CODE	SIZE	FITTING MACHINE	FITTING TOOL
B	AZT3382A	Ø45 L110 mm	M30 breton	Ø50+6M6/63
B	AZT3382B	Ø45 L160 mm	M30 breton	Ø50+6M6/63
B	AZT3382C	Ø45 L110 mm	M30 thibaut	Ø50+6M6/63
B	AZT3382D	Ø45 L160 mm	M30 thibaut	Ø50+6M6/63

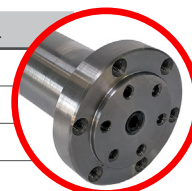

EXTENSIONS FLANGE > M24x2

For Replaceable Ball Heads

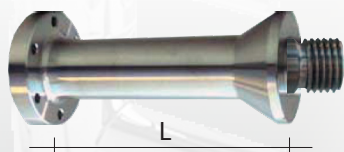

REF	CODE	SIZE	FITTING MACHINE	FITTING TOOL
C	AZT5172A	Ø40 L175 mm	B50+6HØ6.5/63	M24 x2
C	AZT5172B	Ø40 L127 mm	B50+6HØ6.5/63	M24 x2

EXTENSIONS FLANGE > D35

For Replaceable Round Heads

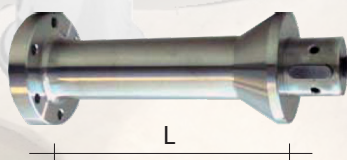

REF	CODE	SIZE	FITTING MACHINE	FITTING TOOL
D	AZT2509A	Ø45 L100 Lu150 mm	B50+6HØ6.5/63	Ø35 x 39 mm
D	AZT2509B	Ø45 L150 Lu200 mm	B50+6HØ6.5/63	Ø35 x 39 mm

FITTING M30 > D35

For Replaceable Round Heads

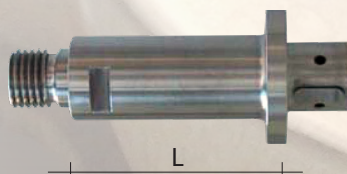

REF	CODE	SIZE	FITTING MACHINE	FITTING TOOL
E	AZT4948A	L70 mm	M30 breton	Ø35 x 39 mm
E	AZT4948B	L140 mm	M30 breton	Ø35 x 39 mm
E	AZT4948C	L70 mm	M30 thibaut	Ø35 x 39 mm
E	AZT4948D	L140 mm	M30 thibaut	Ø35 x 39 mm

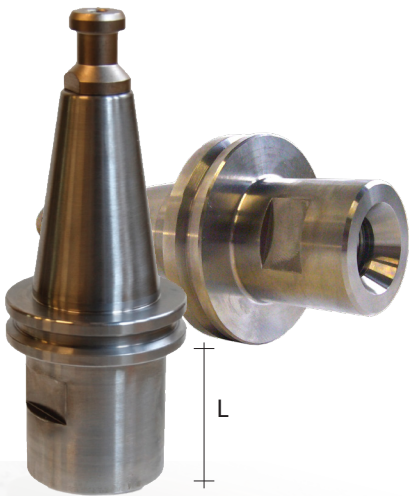

1/2 Gas Cones



**Flanged Cones
D50+6 M6/63**



Wheel Holder



ISO 50 Cones



HSK80 / Breton

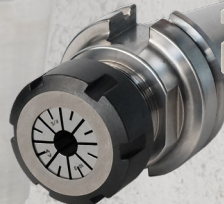

Special Cones



on request we can produce any kind of ISO40 and HSK cone for any kind of machine and with any kind of fitting

CONES

cones



CODE WHEEL HOLDERS	SIZE	CODE 1/2GAS CONES	FITTING	CODE FLANGE CONES	FITTING
ISO40: Intermac / Northwood				INTERMAC	Northwood Machine Manufacturing Co
AZC1826A	Ø22 L34 mm	AZC1004A	1/2G (female) L0mm	AZC1007A	Ø50 Fl. (short) L0mm
AZC1827A	Ø22 L47 mm				
AZC1005A	Ø35 L39 mm				
AZC1825A	Ø35 L47 mm				
AZC1006A	Ø35 L59 mm				
AZC2360A	Ø35 L80 mm				
ISO40: Bavelloni / Pedrini / ScandInvent				BAVELLONI	PEDRINI
AZC1434A	Ø22 L39 mm	AZC1433A	1/2G (female) L20mm	AZC4013A	Ø50 Fl. (short) L22mm
AZC3273A	Ø22 L49 mm				
AZC3743A	Ø22 L60 mm				
AZC3708A	Ø22 L90 mm				
AZC3734A	Ø35 L39 mm				
AZC3734B	Ø35 L65 mm				
AZC3295A	Ø35 L107 mm				
ISO40: Denver / Park Ind.				denver stone & glass machines	Park Industries Precision. Performance. Peace of Mind.
AZC3893A	Ø35 L39 mm	AZC3894A	1/2G (female)	AZC4034A	Ø50 Fl. (short) L22mm
Omag				omac TECHNOLOGY AND MACHINING	
AZC3567A	Ø35 L39 mm	AZC3566A	1/2G (female)	AZC3568A	Ø50 Fl. (short) L22mm
AZC4436A	Ø35 L60 mm			AZC3569A	Ø50 Fl. (long) L120mm
AZC4619A	Ø35 L80 mm				
ISO40: Prussiani				prussiani ENGINEERING	
AZC4663A*	Ø35 L50 mm	AZC3370A*	1/2G (female)	AZC2194A*	Ø50 Fl. (short) L25mm
AZC4018A*	Ø35 L110 mm	AZC4016A	1/2G (female)	AZC4764A	Ø50 Fl. (short) L30mm
AZC4017A	Ø35 L110 mm				
<i>*big size for Oceania / Asia / Enrgia Plus / Europa</i>					
HSK80 Breton				breton	
AZC1946B	Ø35 L32 mm	AZC3165A	1/2G (female)	AZC4564A	M30
AZC1946A	Ø35 L39 mm	AZC1949A	ERG 40	AZC4952A	Ø50 Fl. L44mm
AZC1946D	Ø35 L47 mm				
AZC1946E	Ø35 L80 mm				
ISO40: Donatoni / QDesign / TDRobotics				DONATONI HIGH INNOVATION STONE MACHINES	QD
AZC3734C	Ø35 L39 mm	AZC5118B	1/2G (female) L45 mm	AZC4013D	Ø50 Flange L30 mm
AZC4972B*	L230 mm - Ø60+6M8	AZC5255B	1/2G (female) L75 mm	AZC4203B	Ø50 Flange L300 mm
<i>*blade holder</i>					
ISO40: CMS / Brembana New Style				CMS Brembana	
AZC1066A	Ø35 L39 mm	AZC1069A	1/2G (female)	AZC1067A	Ø50 Flange (short)
AZC2320A	Ø35 L48 mm			AZC1068A	Ø50 Flange (long)
AZC1894A	Ø35 L58 mm				
AZC1423A	Ø35 L80 mm				
<i>Brembana Old Style and other cones available on request</i>					



ISO50 Cones
HSD Robot



CODE	SIZE	L	FITTING
AZC4506B	ISO50	40	Ø50+6B (M6/63) + 1B Ø6/63
AZC5367A	ISO50	100	Ø60+6B (M8/125) BLADE HOLDER
AZC4958A	ISO50	200	Ø60+6B (M8/125) BLADE HOLDER
AZC4505A	ISO50	30	1/2 GAS FEM
AZC4425G	ISO50	50	1/2 GAS FEM
AZC5601A	ISO50	200	1/2 GAS FEM
AZC5784A	ISO50	300	1/2 GAS FEM
AZC4506A	ISO50	40	Ø50+6B (M6/63)
AZC6389B	ISO50	500	Ø50+6+6B Tempered & Balanced
AZC6389A	ISO50	600	Ø50+6+6B Tempered & Balanced
AZC6033A	ISO50	70	PLIERSHOLDER ERG32
AZC6033B	ISO50	100	PLIERSHOLDER ERG32
AZC6033A	ISO50	40	PLIERSHOLDER ERG40

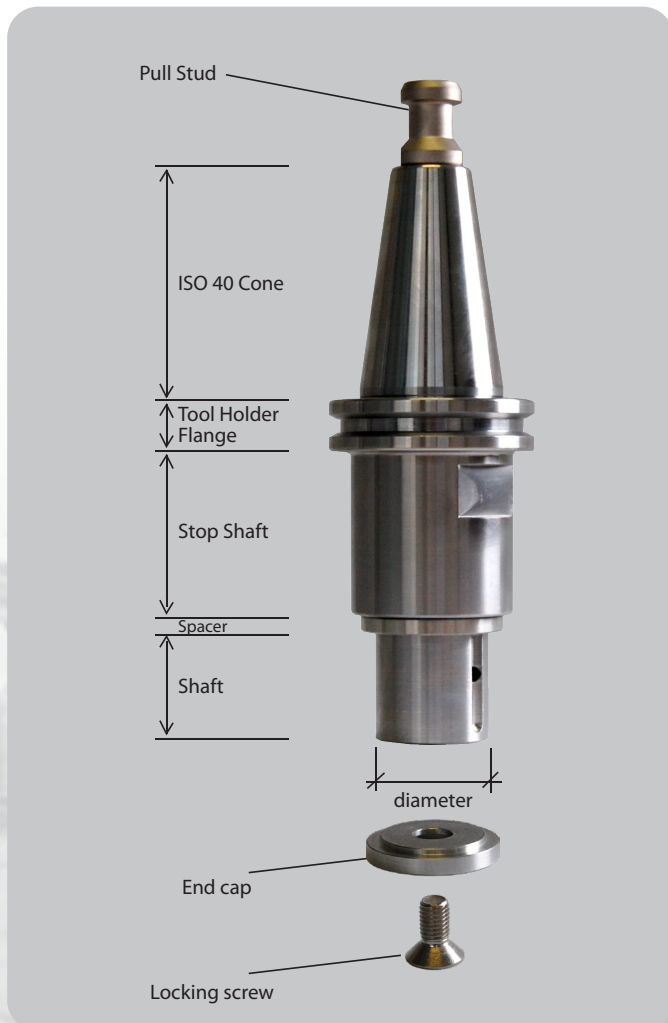

CONES' CLAMPER FOR AN EASY TOOLS UNLOCKING



AZZ00188
CONE ISO40

CONES

cones



DIN69872

Pull Stud for ISO40 Cones



CODE	SIDE
AZT0876A	Ø19 L26 mm

Used for:
Loffler, Omag, Pedrini, Prussiani, Ravelli, Tecno, Scandinvent, Thibaut, Brembana CMS, Helios, Bavelloni, Pedro Cruz, Noat.

ISO7388/2A

Pull Stud for ISO40 Cones



CODE	SIDE
AZT1831A	Ø15 L26 mm

Used for:
Intermac, Nortwood, Bimatec, TD Robotics, Donatoni, Q Design.

BT40

Pull Stud for ISO40 Cones

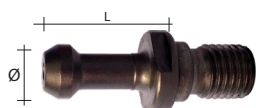

CODE	SIDE
AZT1989A	Ø19 L36 mm

Used for:
Nuova Omecc, Denver, Helios, Park Industry, Bidese, Noat.

DIN69872

Pull Stud for ISO50 Cones

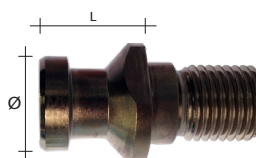

CODE	SIDE
AZT4974A	Ø28 L34 mm

Used for:
Omag, Donatoni, Q Design, Agut.

BERG PINS

SSK-DIN



CODE	SIZE	THREAD	TYPE / MACHINE
AZZ00019	ISO40	Male	CMS Brembana / Prussiani / Ravelli
AZZ00194	ISO40	Female	CMS Brembana
AZZ00223	ISO40	Female	Watertight

TELESCOPIC CONES (w/ Springs)

For Polishing Surface



CODE	SIZE	TYPE / MACHINE
AZC4717A	ISO40	Bavelloni / Pedrini / Scandinvent
AZC5382A	ISO40	Ravelli New
AZC4743A	ISO40	CMS Brembana New



FIXED & TELESCOPIC ADAPTER FOR SLABS POLISHING



TELESCOPIC PLATE w/3 Giotto OR others finishing tools Flange Fitting

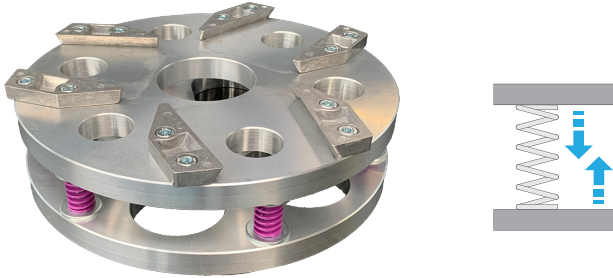

CODE	SIZE	FLANGE FITTING
AZT5769A	Ø300 (12") H115	Bore50+6Holes

The plate with flange fitting is made for 3 tools. It's possible to have 35mm fitting adding the AZT1218B adaptor (sold separately). See Adapters Table.

FIXED MAGNETIC PLATE Flange Fitting

(TO BE USED ONLY WITH MACHINES THAT CAN MANAGE POLISHING PRESSURE)

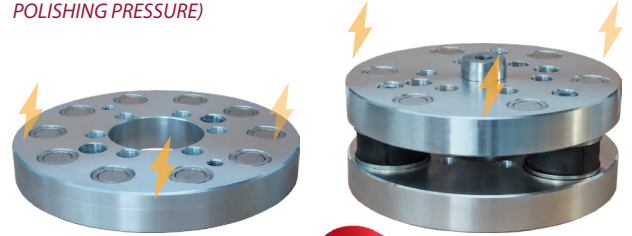

CODE	SIZE	FLANGE FITTING
AZT6154A	Ø150 (6")	Bore50+6Holes
AZT6154B	Ø150 (6") TELESCOPIC	Bore50+6Holes

The plate with flange fitting is made for Sonic discs. You can have 35mm fitting adding the AZT1218B adaptor (sold separately). See Adapters Table.

FIXED PLATE w/3 Giotto OR others finishing tools Flange Fitting

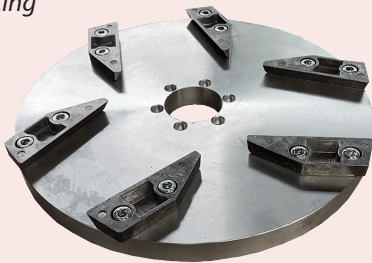

CODE	SIZE	FLANGE FITTING
AZT5769C	Ø300 (12")	Bore50+6Holes

The plate with flange fitting is made for 3 tools. It's possible to have 35mm fitting adding the AZT1218B adaptor (sold separately). See Adapters Table.



See Giotto tooling range in next pages



See Sonic Polishing Discs
MAGNETIC FITTING
in next page



FIXED PLATE FOR VELCRO Flange Fitting

(TO BE USED ONLY WITH MACHINES THAT CAN MANAGE POLISHING PRESSURE)



CODE	SIZE	FLANGE FITTING
AZT6712A	Ø250 (10")	Bore50+6Holes

The plate is for velcro tools. It has flange fitting. It's possible to have 35mm fitting adding the AZT1218B adaptor (sold separately). See Adapters Table below.

ADAPTERS FOR FIXED & TELESCOPIC PLATES from Flange to Bore 35 mm



AZT5769C
AZT6154A
AZT6712A
AZT5769B
AZT5769A

CODE	FLANGE FITTING
AZT1218B Adapter	Bore50+6Holes



See Sonic Polishing Discs
VELCRO FITTING
in next page

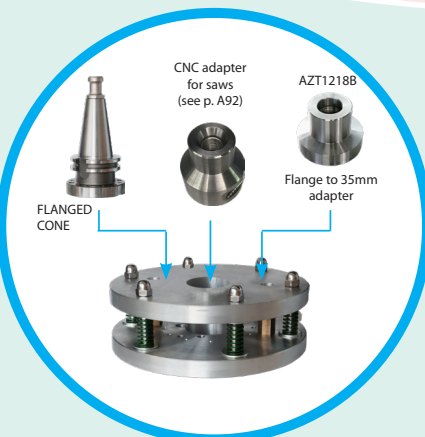

TELESCOPIC ADAPTER FOR SLABS POLISHING



TELESCOPIC PLATE (MAGNETIC) & Adaptors Flange Fitting

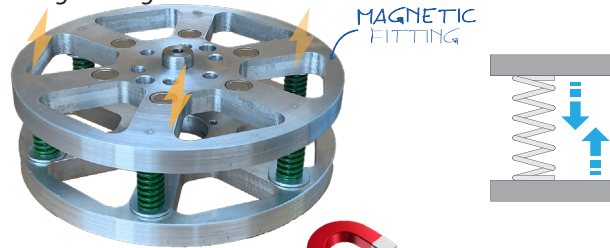

CODE	SIZE	FLANGE FITTING
AZT5769B	Ø250 (10") H115	Bore50+6Holes

Telescopic Plate Magnet Fitting. It's possible to have adaptor for 3 Frankfurts (AZZ0352) or for velcro tools (AZZ00354). With the AZT1218B it's possible to have 35mm bore. (Example on the right)

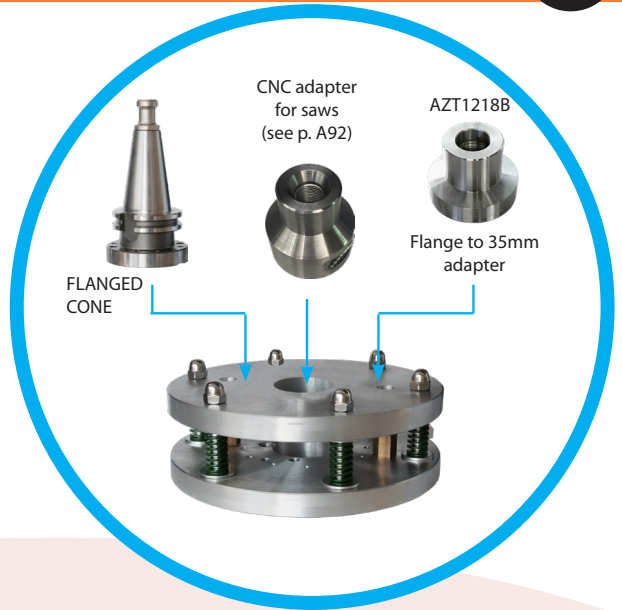

Ready to mount Sonic Discs with magnetic fitting. (See next page for Sonic range)

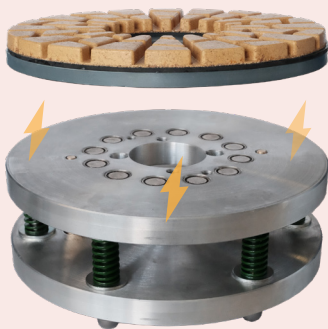

+ ADAPTOR



MAGNETIC TO VELCRO adaptor

CODE	SIZE	FITTING
AZZ00354	Velcro Adapt. Ø250 (10")	Magnetic

=

You can mount Sonic Discs with velcro fitting (see next page for Sonic Range)

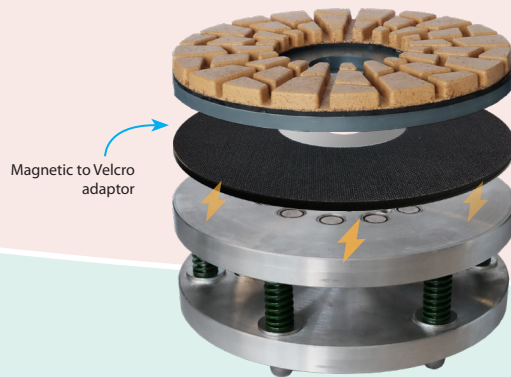

+ ADAPTOR



MAGNETIC TO 3 Frankfurt adaptor

CODE	SIZE	FITTING
AZZ00352	Frankfurt Adapt. Ø300 (12")	Magnetic

=

You can mount 3 Giotto tools OR 3 Finishing tools (i.e. Brushes) (see next page for Giotto Range)

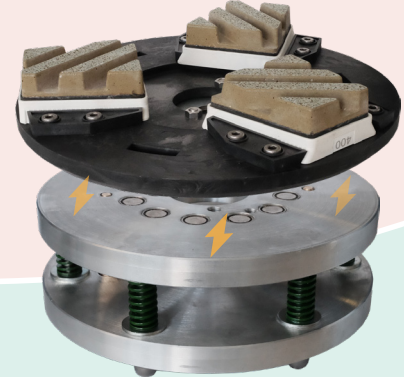

See Sonic Polishing Discs
MAGNETIC FITTING
in next page



See Sonic Polishing Discs
VELCRO FITTING
in next page



See Giotto tooling range
in next page

POLISHING DISCS FOR MARBLE, GRANITE & ES



for MARBLE

Ø250 - 10" Magnetic Fitting (Ø200 - 8" available)



for GRANITE & ENG. STONE

Ø250 - 10" Magnetic Fitting (Ø200 - 8" available)

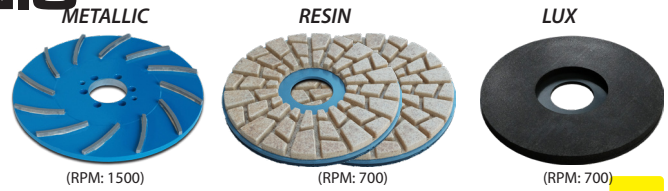
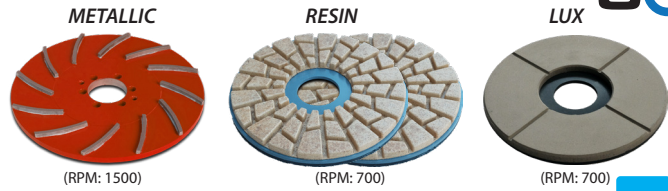

Magnetic Fitting

CODE	TYPE	GRIT	FITTING
ACS200B1	Metallic Plat. Marble	1	B50+6H
ACS200B2	Metallic Plat. Marble	2	B50+6H
ALRMCBMXT00060	Resin Plat. Marble	60	MAGN.
ALRMCBMXT00120	Resin Plat. Marble	120	MAGN.
ALRMCBMXT00220	Resin Plat. Marble	220	MAGN.
ALRMCBMXTL0400	Resin Plat. Marble	400	MAGN.
ALRMCBMXTL0800	Resin Plat. Marble	800	MAGN.
ALRMCBMTL02000	Resin Plat. Marble	2000	MAGN.
ALRMCBMTL05000	Resin Plat. Marble	5000	MAGN.
ALRMCBMMR00LUX	Resin Plat. Marble	LUX	MAGN.

Magnetic Fitting

CODE	TYPE	GRIT	FITTING
ACS200A1	Metallic Plat. GR & ES	1	B50+6H
ACS200A2	Metallic Plat. GR & ES	2	B50+6H
ALRMCBMGE00060	Resin Plat. GR & ES	60	MAGN.
ALRMCBMGE00120	Resin Plat. GR & ES	120	MAGN.
ALRMCBMGE00220	Resin Plat. GR & ES	220	MAGN.
ALRMCBMGE00400	Resin Plat. GR & ES	400	MAGN.
ALRMCBMGE00800	Resin Plat. GR & ES	800	MAGN.
ALRMCBMGE01800	Resin Plat. GR & ES	1800	MAGN.
ALRMCBMGE00LUX	Resin Plat. GR & ES	BUFF	MAGN.

See previous pages
for mounting options
& adaptors

Example:

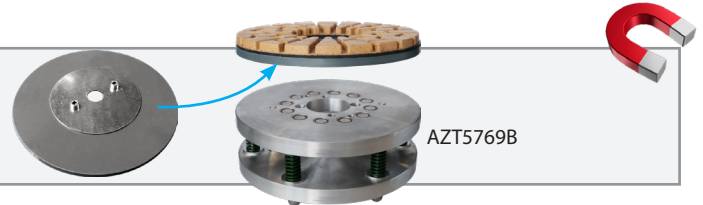

for MARBLE

Ø250 - 10" Velcro Fitting (Ø200 - 8" available)



for GRANITE & ENG. STONE

Ø250 - 10" Velcro Fitting (Ø200 - 8" available)

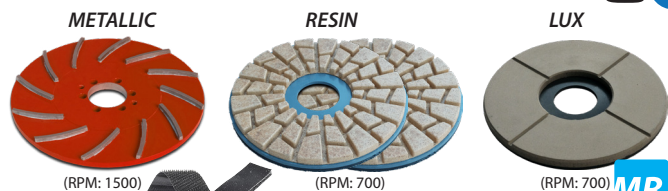

Velcro Fitting

CODE	TYPE	GRIT	FITTING
ACS200B1	Metallic Plat. Marble	1	B50+6H
ACS200B2	Metallic Plat. Marble	2	B50+6H
ALRMCBVXT00060	Resin Plat. Marble	60	VELCRO
ALRMCBVXT00120	Resin Plat. Marble	120	VELCRO
ALRMCBVXT00220	Resin Plat. Marble	220	VELCRO
ALRMCBVXTL0400	Resin Plat. Marble	400	VELCRO
ALRMCBVXTL0800	Resin Plat. Marble	800	VELCRO
ALRMCBVTL02000	Resin Plat. Marble	2000	VELCRO
ALRMCBVTL05000	Resin Plat. Marble	5000	VELCRO
ALRMCBVMR00LUX	Resin Plat. Marble	LUX	VELCRO

Velcro Fitting

CODE	TYPE	GRIT	FITTING
ACS200A1	Metallic Plat. GR & ES	1	B50+6H
ACS200A2	Metallic Plat. GR & ES	2	B50+6H
ALRMCBVGE00060	Resin Plat. GR & ES	60	VELCRO
ALRMCBVGE00120	Resin Plat. GR & ES	120	VELCRO
ALRMCBVGE00220	Resin Plat. GR & ES	220	VELCRO
ALRMCBVGE00400	Resin Plat. GR & ES	400	VELCRO
ALRMCBVGE00800	Resin Plat. GR & ES	800	VELCRO
ALRMCBVGE01800	Resin Plat. GR & ES	1800	VELCRO
ALRMCBVGE00LUX	Resin Plat. GR & ES	BUFF	VELCRO

See previous pages
for mounting options
& adaptors

Example:

AZZ00354

AZT5769B

or

AZT6712A



POLISHING TOOLS FOR MARBLE, GRANITE & ES



for MARBLE



for GRANITE & ENG. STONE

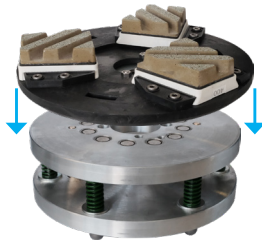

MR

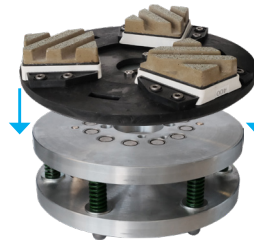

GR

CODE	TYPE	GRIT
ALSF061H	Metallic FRANKFURT	80/100
ALRFC14XT00060	GIOTTO T Resin Frankfurt	60
ALRFC14XTT0120	GIOTTO T Resin Frankfurt	120
ALRFC14XTT0220	GIOTTO T Resin Frankfurt	220
ALRFC14XTL0400	GIOTTO T Resin Frankfurt	400
ALRFC14XTL0800	GIOTTO T Resin Frankfurt	800
ALRFC14TL01800	GIOTTO T Resin Frankfurt	800
CLRF505XVTT	GIOTTO LUX FRANKFURT	5 Extra

(Advised Sequence)

CODE	TYPE	GRIT
ALSF061H	Metallic FRANKFURT	120
ALRFC54GE00060	GIOTTO Resin FRANKFURT	60
ALRFC54GE00120	GIOTTO Resin FRANKFURT	120
ALRFC54GE00220	GIOTTO Resin FRANKFURT	220
ALRFC54GE00400	GIOTTO Resin FRANKFURT	400
ALRFC54GE00800	GIOTTO Resin FRANKFURT	800
ALRFC54GE01800	GIOTTO Resin FRANKFURT	1800
ALRFC54GE00LUX	LUX FRANKFURT	BUFF

(Advised Sequence)



Scan this QRcode to view the Working Parameters

NICOLAI
D I A M A N T

GIOTTO
enhance your colors

www.nicolaigiotto.com



Watch the video @ nicolaigiotto.com

BRUSHES
for GRANITE AND MARBLE
w/ 3 or Brushes

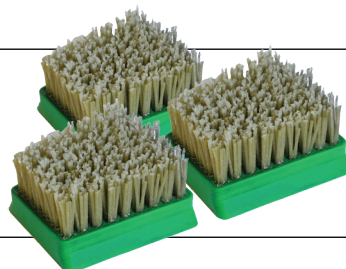

CODE	TYPE	GRIT
CLR2F036	DIAMOND Brush	36
CLR2F060	DIAMOND Brush	60
CLR2H120	SILICON Brush	120
CLR2H240	SILICON Brush	240

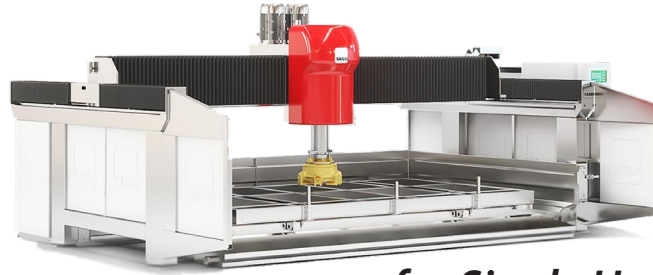

for Single Head Machines

MARBLE Polishing

Tools sequence for Single Head machines

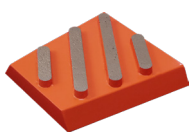

GIOTTO D/S



GIOTTO M



GIOTTO T



5 EXTRA



CLEANER

TYPE	GRITS
FRANKFURT GIOTTO D/S MET.	#6
FRANKFURT GIOTTO M	#5
FRANKFURT GIOTTO T	120 / 220 / 400 / 800 / 1800
FRANKFURT GIOTTO 5 EXTR	5X
FRANKFURT GIOTTO CLEANER	-



MARBLE Honed

Tools sequence for Single Head machines

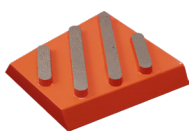

GIOTTO D&S



GIOTTO M/T

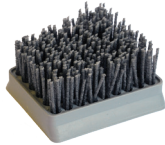

BRUSH SIC

TYPE	GRITS
FRANKFURT GIOTTO D/S MET.	#6
FRANKFURT GIOTTO M SERIES	#5
FRANKFURT GIOTTO T SERIES	120/220
FRANKFURT BRUSH SIC	180/240



MARBLE Leather

Tools sequence for Single Head machines



GIOTTO M



BRUSH DIA

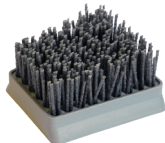

BRUSH SIC

TYPE	GRITS
FRANKFURT GIOTTO M SERIES	#5
FRANKFURT BRUSH DIAMOND	36 / 46 / 60 / 120 / 220
FRANKFURT BRUSH SIC	180 / 240 / 320



GRANITE Polishing

Tools sequence for Single Head machines



GIOTTO BLUE



GIOTTO B-REX



GIOTTO TOP-LUX

TYPE	GRITS
FICKERT GIOTTO BLUE METALLIC	BLUE
FICKERT GIOTTO B-REX	60 / 120 / 220 / 400 / 800 / 1800
FICKERT GIOTTO TOP LUX	LUX





TOOLS FOR SINGLE HEAD MACHINES

GRANITE Honed

Tools sequence for Single Head machines



GIOTTO BLUE



GIOTTO B-REX



BRUSH SIC

TYPE	GRITS
FICKERT GIOTTO BLUE METALLIC	BLUE
FICKERT GIOTTO B-REX	60 / 120 / 220
FICKERT BRUSH SIC	180 / 240



GRANITE Leather

Tools sequence for Single Head machines



GIOTTO B-REX

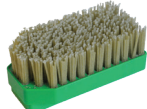

BRUSH DIA



BRUSH SIC

TYPE	GRITS
FICKERT GIOTTO B-REX	#5
FICKERT BRUSH DIAMOND	36 / 46 / 60 / 120 / 220
FICKERT BRUSH SIC	180 / 240 / 320



ENGINEERED STONE & QUARTZ Polishing

Tools sequence for Single Head machines



GIOTTO BLUE

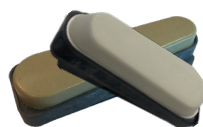

GIOTTO QUARTZ M/T

TYPE	GRITS
FICKERT GIOTTO BLUE METALLIC	BLUE
FICKERT GIOTTO QUARTZ M	120 / 220 / 400
FICKERT GIOTTO QUARTZ T	800 / 1800 / 3500



ENGINEERED STONE & QUARTZ Honed

Tools sequence for Single Head machines



GIOTTO BLUE

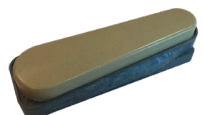

GIOTTO QUARTZ M



BRUSH SIC

TYPE	GRITS
FICKERT GIOTTO BLUE METALLIC	BLUE
FICKERT GIOTTO QUARTZ M	120 / 220
FICKERT BRUSH SIC	180 / 240



ENGINEERED STONE & QUARTZ Leather

Tools sequence for Single Head machines

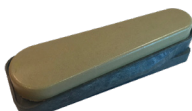

GIOTTO QUARTZ M

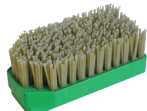

BRUSH DIA



BRUSH SIC

TYPE	GRITS
FICKERT GIOTTO QUARTZ M	120 / 220
FICKERT BRUSH DIAMOND	36 / 46 / 60 / 120 / 220
FICKERT BRUSH SIC	180 / 240 / 320



Finishes

BUSHAMMERING / SANDBLASTING FRANKFURTS

SABBIATURA SANDBLASTING

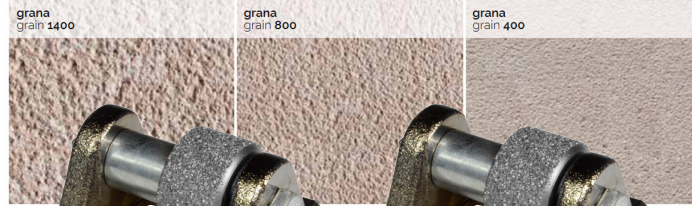

BOCCIARDATURA BUSHAMMERING



BRUSHES FOR FINISHING

L140 FICKERT BRUSHES

SIC ABRASIVE: 36 / 46 / 60 / 80 / 120 / 180
DIA ABRASIVE: 36 / 46 / 60 / 80 / 120 / 180 / 240 / 320

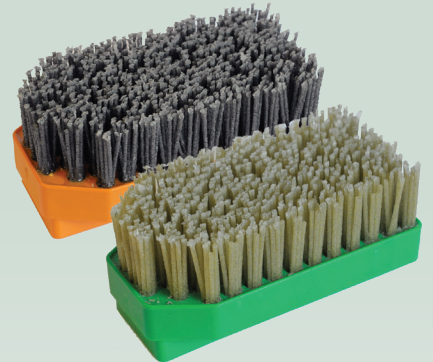

Ø120 BRUSHES

SIC ABRASIVE:
24 / 36 / 46 / 60 / 80 / 120 / 180 / 240 / 320 / 500
DIA ABRASIVE:
24 / 36 / 46 / 60 / 80 / 120 / 180 / 240 / 320 / 500

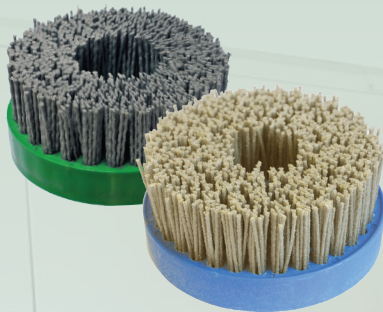

FRANKFURT BRUSHES

SIC ABRASIVE:
24 / 36 / 46 / 60 / 80 / 120 / 180 / 240 / 320 / 500 / 800
DIA ABRASIVE:
24 / 36 / 46 / 60 / 80 / 120 / 180 / 240 / 320 / 500

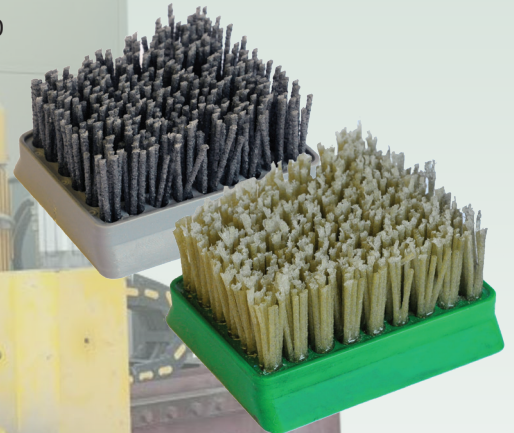

Ø250 BRUSHES

SIC ABRASIVE:
24 / 36 / 46 / 60 / 80 / 120 / 180 / 240 / 320 / 500
DIA ABRASIVE:
24 / 36 / 46 / 60 / 80 / 120 / 180 / 240 / 320 / 500

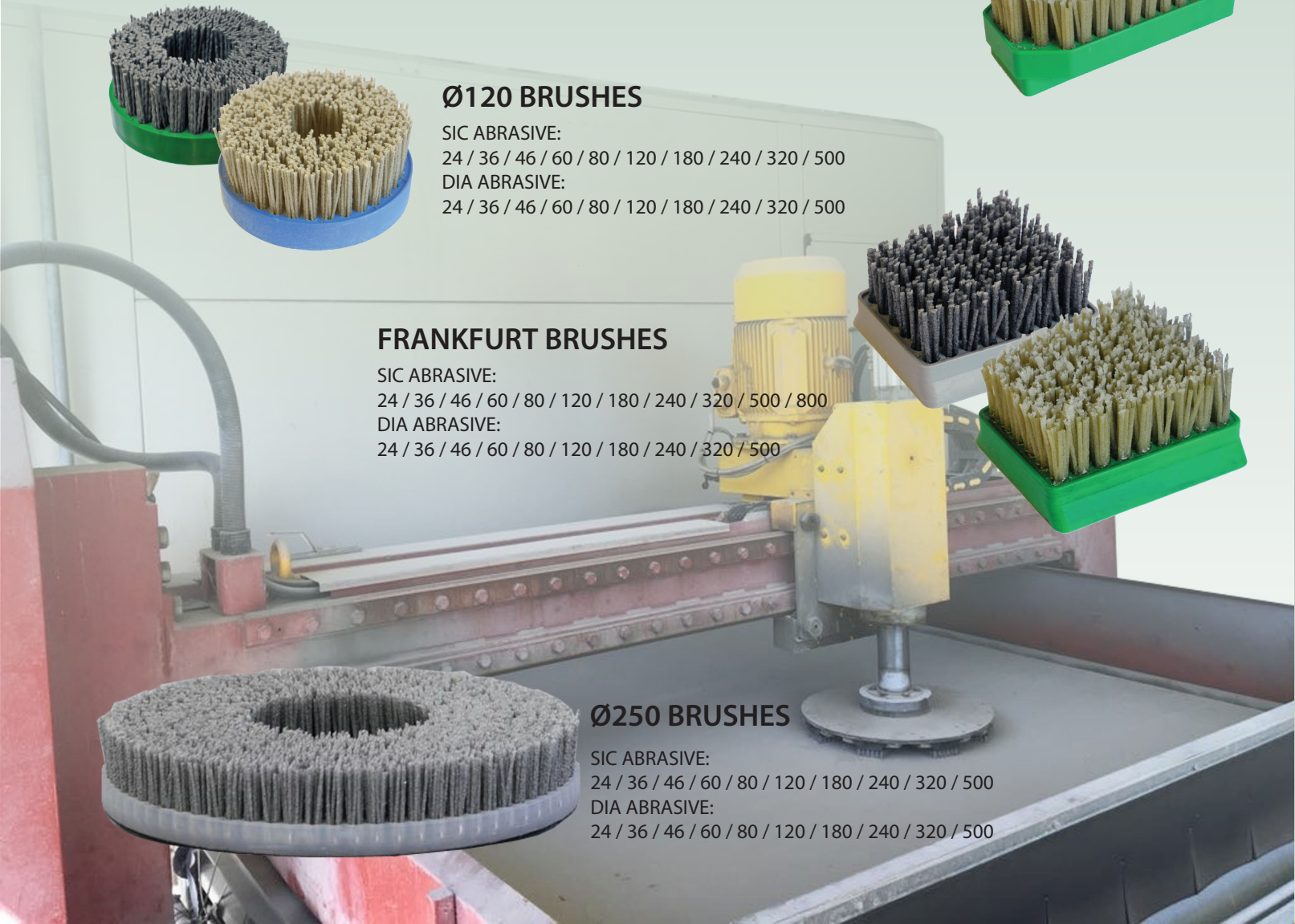

HOW TO CHOOSE THE CORRECT EXTENSION/ADAPTOR FOR STUBBING WHEELS

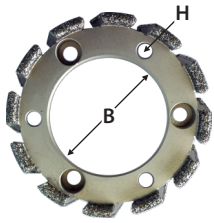

BORE (B): Ø50mm
HOLE (H): No 3+3 Ø7/63

+

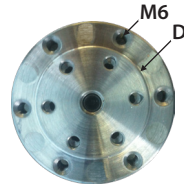

FLANGE EXTENSION
D50 +6 M6/63
to Flange, 1/2 Gas or M36

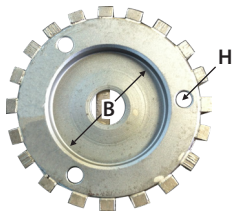

BORE (B): Ø50mm
HOLE (H): No 3 Ø7/63

+

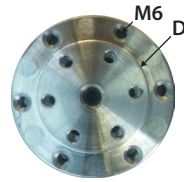

FLANGE EXTENSION
D50 +6 M6/63
to Flange, 1/2 Gas or M36

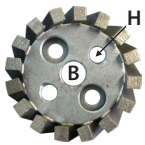

BORE (B): Ø10mm
HOLE (H): No 2+2 Ø7/25

+

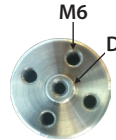

SMALL FLANGE 1
D10 +2 M6/25
to Flange, 1/2 Gas or M36

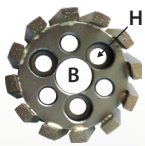

BORE (B): Ø14mm
HOLE (H): No 3+3 Ø7/25

+

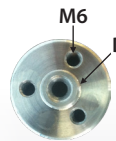

SMALL FLANGE 2
D14 +3 M6/25
to Flange, 1/2 Gas or M36

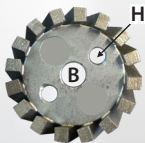

BORE (B): Ø8.5 TSEI
HOLE (H): No 2H Ø4/20

+

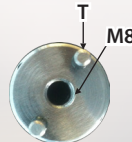

LITTLE DIAMETER FLANGE
M8 +2T Ø4/20
to Flange, 1/2 Gas or M36

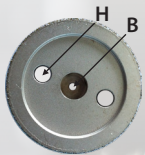

BORE (B): Ø10mm
HOLE (H): No 2 Ø7/25

+



SMALL FLANGE 1
D10 +2 M6/25
to Flange, 1/2 Gas or M36

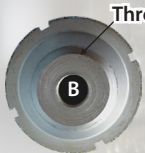

FITT: 1/2 Gas

+



1/2 GAS FEMALE
to Flange, 1/2 Gas or M36

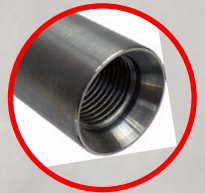



EXTENSIONS FLANGE

Flange > Flange male

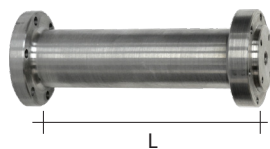

CODE	SIZE	FITT. MACHINE	FITT. TOOL
AZT0583A	Ø45 L100 mm	B50+6HØ6.5/63	Ø50+6M6/63
AZT0584A	Ø45 L133 mm	B50+6HØ6.5/63	Ø50+6M6/63
AZT0734A ☺	Ø45 L207 mm	B50+6HØ6.5/63	Ø50+6M6/63
AZT2501A	Ø45 L300 mm	B50+6HØ6.5/63	Ø50+6M6/63
AZT3753A	Ø45 L400 mm	B50+6HØ6.5/63	Ø50+6M6/63

EXTENSIONS FLANGE

Flange > 1/2 Gas (female)



CODE	SIZE	FITT. MACHINE	FITT. TOOL
AZT0587A	Ø28 L100 mm	B50+6HØ6.5/63	1/2 Gas (female)
AZT0588A	Ø28 L150 mm	B50+6HØ6.5/63	1/2 Gas (female)
AZT0589A ☺	Ø28 L200 mm	B50+6HØ6.5/63	1/2 Gas (female)
AZT0590A	Ø28 L250 mm	B50+6HØ6.5/63	1/2 Gas (female)
AZT4917A	Ø28 L300 mm	B50+6HØ6.5/63	1/2 Gas (female)
AZT1338A	Ø38 L400 mm	B50+6HØ6.5/63	1/2 Gas (female)

EXTENSIONS FLANGE

Flange > Flange -1-

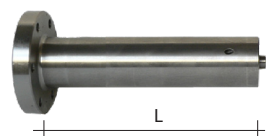

CODE	SIZE	FITT. MACHINE	FITT. TOOL
AZT3450A	Ø38 L60 mm	B50+6HØ6.5/63	Ø10 + 2 M6/25
AZT2354A ☺	Ø38 L133 mm	B50+6HØ6.5/63	Ø10 + 2 M6/25
AZT2353A	Ø38 L185 mm	B50+6HØ6.5/63	Ø10 + 2 M6/25
AZT1381A ☺	Ø38 L224 mm	B50+6HØ6.5/63	Ø10 + 2 M6/25
AZT4254A	Ø38 L300 mm	B50+6HØ6.5/63	Ø10 + 2 M6/25
AZT4352A	Ø38 L400 mm	B50+6HØ6.5/63	Ø10 + 2 M6/25
AZT4353A	Ø38 L500 mm	B50+6HØ6.5/63	Ø10 + 2 M6/25

EXTENSIONS FLANGRE

Flange > Flange -2-

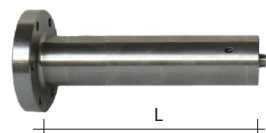

CODE	SIZE	FITT. MACHINE	FITT. TOOL
AZT5099A	Ø38 L77 mm	B50+6HØ6.5/63	Ø14 + 3 M6/25
AZT5119A	Ø38 L175 mm	B50+6HØ6.5/63	Ø14 + 3 M6/25
AZT4661A ☺	Ø38 L210 mm	B50+6HØ6.5/63	Ø14 + 3 M6/25
AZT4485A	Ø38 L300 mm	B50+6HØ6.5/63	Ø14 + 3 M6/25

☺ = ADVISED



EXTENSIONS FLANGE

Flange > Flange -3-

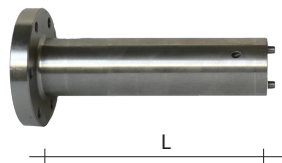

CODE	SIZE	FITT. MACHINE	FITT. TOOL
AZT5071A	Ø30 L150 mm	B50+6HØ6.5/63	M8 + 2T
AZT5071B	Ø30 L200 mm	B50+6HØ6.5/63	M8 + 2T

EXTENSIONS FLANGE

Flange > D35

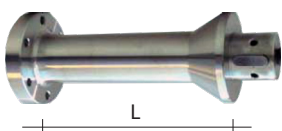

CODE	SIZE	FITT. MACHINE	FITT. TOOL
AZT2509A	Ø45 L100 Lu150 mm	B50+6HØ6.5/63	Ø35 x 39 mm
AZT2509B	Ø45 L150 Lu200 mm	B50+6HØ6.5/63	Ø35 x 39 mm

EXTENSIONS FLANGE

Flange > M24 x2

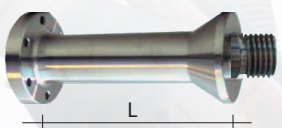

CODE	SIZE	FITT. MACHINE	FITT. TOOL
AZT5172A	Ø40 L175 mm	B50+6HØ6.5/63	M24 x2
AZT5172B	Ø40 L127 mm	B50+6HØ6.5/63	M24 x2





EXTENSIONS 1/2 GAS

1/2 Gas > 1/2 Gas (female)



CODE	SIZE	THREAD	FITT MACHINE	FITT TOOL
AZT0821A ☺	Ø28 L50 mm	Right	1/2 Gas	1/2 Gas (female)
AZT0822A ☺	Ø28 L80 mm	Right	1/2 Gas	1/2 Gas (female)
AZT2578A	Ø28 L100 mm	Right	1/2 Gas	1/2 Gas (female)
AZT1738A	Ø28 L150 mm	Right	1/2 Gas	1/2 Gas (female)
AZT3332A ☹	Ø28 L200 mm	Right	1/2 Gas	1/2 Gas (female)

FITTING 1/2 GAS

1/2 Gas > Flange



CODE	SIZE	THREAD	FITT MACHINE	FITT TOOL
AZT0566A ☺	Ø 72 mm	Right	1/2 Gas	Ø50+6M6/63
AZT5122A	Ø 72 mm	Right	1/2 Gas	Ø50+4M6/63
AZT5230A	Ø 72 mm	Right	M30	Ø50+6M6/63
AZT0983A	Ø 120 mm	Right	M30	Ø60+6M8/100

FITTING 1/2 GAS

1/2 Gas > Flange -1-



CODE	SIZE	THREAD	FITT MACHINE	FITT TOOL
AZT0765A ☺	Ø30 L30 mm	Right	1/2 Gas	Ø10 + 2 M6/25
AZT0573A ☺	Ø30 L80 mm	Right	1/2 Gas	Ø10 + 2 M6/25
AZT2513A ☺	Ø30 L100 mm	Right	1/2 Gas	Ø10 + 2 M6/25
AZT1320A	Ø30 L150 mm	Right	1/2 Gas	Ø10 + 2 M6/25
AZT1410A ☹	Ø30 L212 mm	Right	1/2 Gas	Ø10 + 2 M6/25

FITTING 1/2 GAS

1/2 Gas > Flange -2-

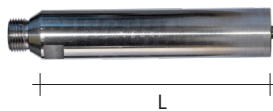

CODE	SIZE	THREAD	FITT MACHINE	FITT TOOL
AZT4383A ☺	Ø30 L30 mm	Right	1/2 Gas	Ø14 + 3 M6/25
AZT4383D ☺	Ø30 L60 mm	Right	1/2 Gas	Ø14 + 3 M6/25
AZT4383H	Ø30 L132 mm	Right	1/2 Gas	Ø14 + 3 M6/25
AZT4383G	Ø30 L160 mm	Right	1/2 Gas	Ø14 + 3 M6/25
AZT4383F ☹	Ø30 L190 mm	Right	1/2 Gas	Ø14 + 3 M6/25

☺ = ADVISED



FITTING 1/2 GAS

1/2 Gas > Flange -3-



CODE	SIZE	THREAD	FITT MACHINE	FITT TOOL
AZT4448A	L30 mm	Right	1/2 Gas	M8 + 2T
AZT4448B	L150 mm	Right	1/2 Gas	M8 + 2T
AZT4448C	L60 mm	Right	1/2 Gas	M8 + 2T



FITTING 1/2 GAS

1/2 Gas > M10

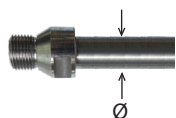

CODE	SIZE	THREAD	FITT MACHINE	FITT TOOL
AZT1518B	Ø17 x 46 Lu60	Right	1/2 Gas	M10
AZT1518G ☺	Ø17 x 30 mm	Right	1/2 Gas	M10
AZT1518F	Ø18 x 60 mm	Left	1/2 Gas	M10



FITTING 1/2 GAS

1/2 Gas > M12

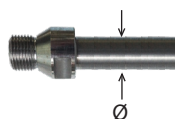

CODE	SIZE	THREAD	FITT MACHINE	FITT TOOL
AZT1518E ☺	Ø17 x 30 mm	Right	1/2 Gas	M12
AZT1518A ☺	Ø17 x 46 Lu60	Right	1/2 Gas	M12
AZT1518F	Ø18 x 100 mm	Right	1/2 Gas	M12
AZT1518T	Ø18 x 120 mm	Right	1/2 Gas	M12
AZT1518W	Ø18 x 150 mm	Right	1/2 Gas	M12
AZT15187 ☺	Ø17 x 30 mm	Left	1/2 Gas	M12
AZT1518L ☺	Ø18 x 60 mm	Left	1/2 Gas	M12
AZT1518Q	Ø18 x 100 mm	Left	1/2 Gas	M12



FITTING 1/2 GAS

1/2 Gas > M14

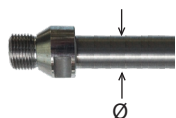

CODE	SIZE	THREAD	FITT MACHINE	FITT TOOL
AZT5105A	Ø19 x 40 mm	Right	1/2 Gas	M14
AZT1518U	Ø19 x 120 mm	Right	1/2 Gas	M14
AZT3976A	Ø20 x 125 mm	Right	1/2 Gas	M14
AZT1518Z	Ø19 x 100 mm	Left	1/2 Gas	M14



☺ = ADVISED



WHEEL HOLDERS 1/2 GAS

1/2 Gas > Thread

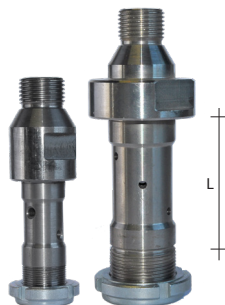

CODE	SIZE	THREAD	FITT MACHINE	FITT TOOL
AZT0559A	Ø20 L38 mm	Right	1/2 Gas	M20 x1
AZT0731A	Ø20 L48 mm	Right	1/2 Gas	M20 x1
AZT1424A	Ø20 L52 mm	Right	1/2 Gas	M20 x1
AZT0560A	Ø20 L68 mm	Right	1/2 Gas	M20 x1
AZT1228A	Ø20 L82 mm	Right	1/2 Gas	M20 x1
AZT0977A	Ø22 L40 mm	Right	1/2 Gas	M22 x1
AZT1820A	Ø25 L80 mm	Right	1/2 Gas	M25 x1
AZT0561A	Ø30 L48 mm	Right	1/2 Gas	M30 x1.5
AZT0562A	Ø30 L58 mm	Right	1/2 Gas	M30 x1.5
AZT0563A	Ø30 L68 mm	Right	1/2 Gas	M30 x1.5
AZT0564A	Ø30 L78 mm	Right	1/2 Gas	M30 x1.5
AZT0730A	Ø35 L38 mm	Right	1/2 Gas	M35 x1.5
AZT0565A	Ø35 L48 mm	Right	1/2 Gas	M35 x1.5
AZT0882A	Ø35 L58 mm	Right	1/2 Gas	M35 x1.5
AZT1057A	Ø35 L68 mm	Right	1/2 Gas	M35 x1.5
AZT2348A	Ø35 L78 mm	Right	1/2 Gas	M35 x1.5
AZT2681A	Ø35 L80 mm	Right	1/2 Gas	M35 x1.5

FITTINGS 1/2 GAS

1/2 Gas > Holder for Collet ERG 20



CODE	SIZE	THREAD	FITT MACHINE	FITT TOOL
AZT0571A *	L40 mm	Right	1/2 Gas	Erg20
AZT0571B *	L40 mm	Left	1/2 Gas	Erg20
AZZ00012 **	Pliers		D6 mm	Erg20
AZZ00013 **	Pliers		D8 mm	Erg20
AZZ00014 **	Pliers		D10 mm	Erg20
AZZ0890A ***	Clamp			

FITTINGS 1/2 GAS

1/2 Gas > Holder for Collet ERG 32



CODE	SIZE	THREAD	FITT MACHINE	FITT TOOL
AZT4194A *	L52 mm	Right	1/2 Gas	Erg32
AZT4194B *	L110 mm	Right	1/2 Gas	Erg32
AZT4194C *	L52 mm	Left	1/2 Gas	Erg32
AZZ00005 **	Pliers		D6 mm	Erg32
AZZ00006 **	Pliers		D8 mm	Erg32
AZZ00007 **	Pliers		D10 mm	Erg32
AZZ00010 **	Pliers		D20 mm	Erg32
AZZ0889A ***	Clamp			



EXTENSIONS M36 (GMM)

M36 > Flange

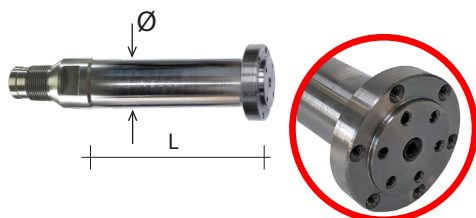

CODE	SIZE	THREAD	FITT MACHINE	FITT TOOL
AZT5392A	Ø45 L200 mm	Right	M36 x2	Ø50+6M6/63
AZT5393A	Ø45 L300 mm	Right	M36 x2	Ø50+6M6/63
AZT5394A	Ø45 L500 mm	Right	M36 x2	Ø50+6M6/63
AZT4127A ☺	Ø45 L150 mm	Left	M36 x2	Ø50+6M6/63
AZT4279A ☺	Ø45 L200 mm	Left	M36 x2	Ø50+6M6/63
AZT5393B	Ø45 L300 mm	Left	M36 x2	Ø50+6M6/63
AZT5394B	Ø45 L500 mm	Left	M36 x2	Ø50+6M6/63

EXTENSIONS M36 (GMM)

M36 > 1/2 Gas (female)

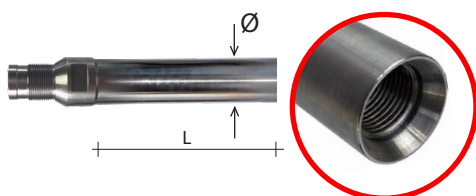

CODE	SIZE	THREAD	FITT MACHINE	FITT TOOL
AZT3378A	Ø27 L25 mm	LEFT	M36 x2	1/2 Gas (female)
AZT3378B	Ø27 L25 mm	Right	M36 x2	1/2 Gas (female)
AZT6087A ☺	Ø27 L100 mm	Right	M36 x2	1/2 Gas (female)
AZT6087E ☺	Ø27 L150 mm	Right	M36 x2	1/2 Gas (female)
AZT6087B	Ø27 L200 mm	Right	M36 x2	1/2 Gas (female)
AZT6087C	Ø27 L100 mm	Left	M36 x2	1/2 Gas (female)
on request	Ø27 L150 mm	Left	M36 x2	1/2 Gas (female)
on request	Ø27 L200 mm	Left	M36 x2	1/2 Gas (female)

EXTENSIONS M36 (GMM)

M36 > Flange -1-

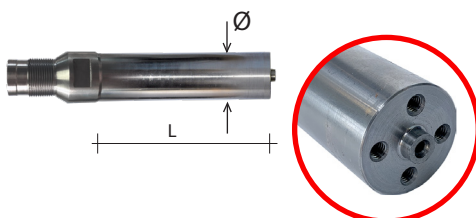

CODE	SIZE	THREAD	FITT MACHINE	FITT TOOL
on request	Ø38 L170 mm	Right	M36 x2	Ø10 + 2 M6/25
AZT3631C	Ø38 L210 mm	Right	M36 x2	Ø10 + 2 M6/25
AZT3324A ☺	Ø38 L170 mm	Left	M36 x2	Ø10 + 2 M6/25
AZT3631A	Ø38 L210 mm	Left	M36 x2	Ø10 + 2 M6/25

EXTENSIONS M36 (GMM)

M36 > Flange -2-

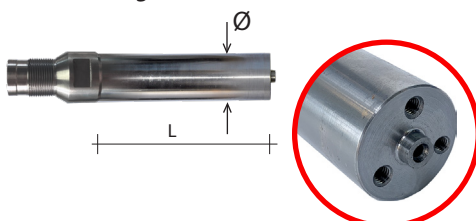

CODE	SIZE	THREAD	FITT MACHINE	FITT TOOL
AZT5361B ☺	Ø38 L100 mm	Right	M36 x2	Ø14 + 3 M6/25
AZT5362B ☺	Ø38 L200 mm	Right	M36 x2	Ø14 + 3 M6/25
AZT5363B	Ø38 L300 mm	Right	M36 x2	Ø14 + 3 M6/25
AZT5361A ☺	Ø38 L100 mm	Left	M36 x2	Ø14 + 3 M6/25
AZT4821A	Ø38 L180 mm	Left	M36 x2	Ø14 + 3 M6/25
AZT5362A ☺	Ø38 L200 mm	Left	M36 x2	Ø14 + 3 M6/25
AZT5363A	Ø38 L300 mm	Left	M36 x2	Ø14 + 3 M6/25

☺ = ADVISED



FITTINGS M36 (GMM)

M36 > Flange -3-



CODE	SIZE	THREAD	FITT MACHINE	FITT TOOL
AZT5401B	Ø30 L100 mm	Right	M36 x2	M8 + 2T
AZT5402B	Ø30 L250 mm	Right	M36 x2	M8 + 2T
AZT5401A	Ø30 L100 mm	Left	M36 x2	M8 + 2T
AZT5402A	Ø30 L250 mm	Left	M36 x2	M8 + 2T



FITTING M36 (GMM)

M36 > Flange



CODE	SIZE	THREAD	FITT MACHINE	FITT TOOL
AZT4786B		Right	M36 x2	Ø50+6
AZT4786A		Left	M36 x2	



FITTING M36 (GMM)

M36 > Holder for Collet ERG 32



CODE	SIZE	THREAD	FITT MACHINE	FITT TOOL
AZT5364B *	L120 mm	Right	M36 x2	Erg32
AZT5364A *	L120 mm	Left	M36 x2	Erg32
AZZ00005 **	Pliers		Ø6 mm	Erg32
AZZ00006 **	Pliers		Ø8 mm	Erg32
AZZ00007 **	Pliers		Ø10 mm	Erg32
AZZ0889A ***	Clamp			

CNC ADAPTER FOR SAWS

1/2GAS, Flange, Wheel Holder



CODE	MACHINE	THREAD	FITT MACHINE	FITT TOOL
AZT6842H *	DONATONI	LEFT	M48 x3	1/2GAS female
AZT6842I **	DONATONI	LEFT	M48 x3	Wheels Holder Ø35
AZT6842A ***	DONATONI	LEFT	M48 x3	Flange Ø50+6B
AZT4176B ***	CMS (see note)	LEFT	M48 x3 L97	Flange Ø50+6B
AZT4176C **	CMS	LEFT	M48 x3 L137	Wheels Holder Ø35
AZT6273B	CMS (Gixa)	LEFT	M56 X4 L97	Flange Ø50+6B
AZT6273C	CMS (Gixa)	LEFT	M56 X4 L97	Flange + 1/2gas female
AZT7071A	CMS (Frontex)	LEFT	M48 x3 L87	Flange Ø50+6B+6B
AZT6842D	EMMEDUE	LEFT	M39 x4 L85	Flange Ø50+6B
AZT6842G	EMMEDUE astra	LEFT	M36 x4	Flange Ø50+6B



note: for CMS Sprint, Venkom, Kosmos, Formax, Impact



FITTINGS 1/2 GAS (HOLDERS FOR NOCORING BIT)
Can Also Be Used for T31



CODE	FITTING
AZT0572B	1/2 Gas > Bore 10 *
AZT0572A	1/2 Gas > Bore 12 *
AZT0614A	ADAPTER D12 ** > Bore 8
AZT0614B	ADAPTER D12 ** > Bore 6
AZT0614C	ADAPTER D12 ** > Bore 5
AZT0591A	M14 FEM > Bore 10
AZT0591B	M14 FEM > Bore 12

FITTING
1/2 Gas > M16 male



CODE	FITTING
AZT2403A	M16 > 1/2 Gas

FITTINGS FOR DRAINBOARD / POLISHING WHEELS
Thread > Magnetic



CODE	FITTING
AZT0743B	M14 > Magnetic
AZT0743A	M16 > Magnetic
AZT2610C	1/2 Gas > Magnetic
AZT2610C	Magnetic > M12

FITTING BRONZE FOR STUBBING WHEELS
Ø50 mm + 3 holes - 35 mm bore



CODE	FITTING
AZT1218A	Ø50+3H (BRONZE)
AZT1218B	Ø50+6H + bore Ø12.5 (INOX)

REDUCTION BRONZE (FOR PROFILING WHEELS)
From 35 to 22 mm (Bavelloni)

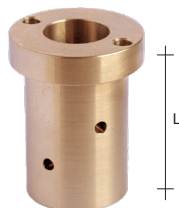

CODE	SIZE
AZT2105A	35 x 22 x 41 mm
AZT2105B	35 x 22 x 48 mm
AZT2105C	35 x 22 x 58 mm

REDUCTION BRONZE FOR PROFILING WHEELS
From 35 to 30 mm

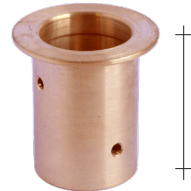

CODE	SIZE
AZT2619A	35 x 30 x 41 mm
AZT2620A	35 x 30 x 48 mm
AZT2783A	35 x 30 x 58 mm

REDUCTION BRONZE FOR PROFILING WHEELS
NOTE: Order 2 Pieces Per Wheels



CODE	SIZE
AZT0816A	35 x 20 mm
AZT0817A	35 x 22 mm
AZT0879B	35 x 25 mm
AZT0818A	35 x 30 mm

REDUCTION BRONZE FOR PROFILING WHEELS
NOTE: Order 2 Pieces Per Wheels



CODE	SIZE
AZT0819A	30 x 20 mm
AZT0820A	30 x 22 mm



CROWN MILL Ø30

$F=1/2Gas$



CODE	SIZE	FITTING	RPM	FEED
DFS3705Y	Ø30 x 15 mm	1/2 Gas LT	4200-4800	800-2000 mm/min



CROWN MILL SMALLER DIAMETER



CODE	SIZE	FITTING	RPM	FEED
CFS4C067	Ø20 x 20 mm	M12 LT	4200-4800	800-2000 mm/min
AFS40084	Ø15 x 20 mm	1/2 Gas LT		
CFS40131	Ø10 x 10 mm	1/2 Gas LT		
CFS40133CER	Ø15 x 10 mm	1/2 Gas LT		<i>for Ceramics</i>
CFS40131CER	Ø10 x 10 mm	1/2 Gas LT		<i>for Ceramics</i>



CROWN MILL Ø20 ELECTROPLATED

w/ M12



CODE	SIZE	FITTING	RPM	FEED
EFE00222	Ø20 x 20 mm	M12 LT	4200-4800	800-2000 mm/min
AFE41026	Ø20 x 10 mm	M12 LT		



CUTTING FINGERBIT WITH SEGMENT ON TOP

$F=1/2Gas$

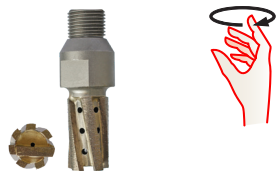

CODE	SIZE	FITTING	RPM	FEED
AFS91090	Ø23 x 40 mm	1/2 Gas LT	4800-5500	250-500 mm/min
AFS91091	Ø23 x 50 mm	1/2 Gas LT		



BASE FINGERBIT (THREADED FOR THE ADDITION OF REPLACEABLE TIPS)

$F=1/2Gas$



CODE	SIZE	FITTING	RPM	FEED
EFE00252	Ø20 x 40 mm	M12 on bottom	1/2 Gas LT	4500-5200
DFE35853	Ø20 x 80 mm	M12 on bottom	1/2 Gas LT	250-500 mm/min
EFE00222 *	Ø20 x 20 mm	Replaceable Head	M12 LT	



LEFT THREAD MILLS

left thread tools



CUTTING FINGERBIT ELECTROPLATED

F=1/2Gas



CODE	SIZE	FITTING	RPM	FEED
AFE80010	Ø16 x 40 mm	1/2 Gas	4800-5500	250-500 mm/min
AFE80066	Ø16 x 50 mm	1/2 Gas		
AFE80030	Ø20 x 70 mm	1/2 Gas		



CONIC FINGERBIT ELECTROPLATED

F=1/2Gas



CODE	SIZE	FITTING	RPM	FEED
AFE30011	Ø14/20 L40/40	1/2 Gas	6000-7000	150-300 mm/min
EFE00046	Ø14/20 L40/100	1/2 Gas		



BASE FINGERBIT ELECTROPLATED (THREADED FOR THE ADDITION OF REPLACEABLE TIPS)

F=1/2Gas



CODE	SIZE	FITTING	RPM	FEED
AFE40031	Ø18/20 Ld15 Lu30	1/2 Gas > M10	6000-7000	150-300 mm/min
AFE42011 *	Ø14/18 L25	M10		



CONIC MILLS WIDIA

F=1/2Gas



CODE	SIZE	FITTING	RPM	FEED
AFW50006 *	Ø3x30 mm	1/2 Gas	8000	150 mm/min

* NOTE: Very long delivery time (6-8 weeks)



CONIC MILLS WIDIA & PCD

For Carving w/ Cylindrical Shank



CODE	SIZE	SHANK	RPM	FEED
AFW60009 *	Ø10 α90°	Ø10	8000-10000	150-250 mm/min

* NOTE: Very long delivery time (6-8 weeks)





CORE DRILLS - THIN WALL

F=1/2Gas



CODE	SIZE	FITTING	THREAD
APF20008	Ø8 (5/16") L95/135	1/2 Gas LT	Left
APF20010	Ø10 (13/32") L95/135	1/2 Gas LT	Left
APF20012	Ø12 (15/32") L95/135	1/2 Gas LT	Left
APF21025	Ø25 (1") L55/95	1/2 Gas LT	Left
APF20025	Ø25 (1") L95/135	1/2 Gas LT	Left
APF20028	Ø28 (1-7/64") L95/135	1/2 Gas LT	Left
APF24030	Ø30 (1-3/16") L40/66	1/2 Gas LT	Left
APF21030	Ø30 (1-3/16") L55/95	1/2 Gas LT	Left
APF24035	Ø35 (1-3/8") L40/66	1/2 Gas LT	Left
APF21035	Ø35 (1-3/8") L55/95	1/2 Gas LT	Left
APF20035	Ø35 (1-3/8") L95/135	1/2 Gas LT	Left
APF20045	Ø45 (1-49/64") L95/135	1/2 Gas LT	Left



CORE DRILLS - THIN WALL

F=1/2Gas (suitable for machine CMS SPRINT)



CODE	SIZE	FITTING	THREAD
APF2X010	Ø10 (13/32") L45/79	1/2 Gas LT	Left
APF2X012	Ø12 (15/32") L45/79	1/2 Gas LT	Left
APF2X015	Ø15 (19/32") L45/79	1/2 Gas LT	Left
APF2X018	Ø18 (45/64") L45/79	1/2 Gas LT	Left
APF2X020	Ø20 (25/32") L45/79	1/2 Gas LT	Left
APF2X025	Ø25 (1") L45/79	1/2 Gas LT	Left
APF2X028	Ø28 (1-7/64") L45/79	1/2 Gas LT	Left
APF2X030	Ø30 (1-3/16") L45/79	1/2 Gas LT	Left
APF2X035	Ø35 (1-3/8") L45/79	1/2 Gas LT	Left
APF2X040	Ø40 (1-37/64") L45/79	1/2 Gas LT	Left
APF2X045	Ø45 (1-49/64") L45/79	1/2 Gas LT	Left
APF2X050	Ø50 (2") L45/79	1/2 Gas LT	Left
APF2X068	Ø68 (2-43/64") L45/79	1/2 Gas LT	Left
APF2X075	Ø75 (2-61/64") L45/79	1/2 Gas LT	Left
APF2X080	Ø80 (3-5/32") L45/79	1/2 Gas LT	Left



LEFT THREAD CORE BITS

left thread tools



CORE DRILLS - SEGMENTED

F=1/2Gas

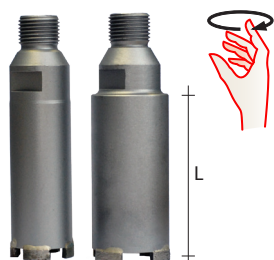

CODE	SIZE	FITTING	THREAD
APSAD020	Ø20 (25/32") L150	1/2 Gas LT	Left
APSAB025	Ø25 (1") L70	1/2 Gas LT	Left
APSAF030	Ø30 (1-3/16") L200	1/2 Gas LT	Left
DPS4444S	Ø35 (1-3/8") L41	1/2 Gas LT	Left
EPS00009	Ø35 (1-3/8") L100	1/2 Gas LT	Left
APSAP035	Ø35 (1-3/8") L120	1/2 Gas LT	Left
APSAD035	Ø35 (1-3/8") L150	1/2 Gas LT	Left
APSAQ035	Ø35 (1-3/8") L350	1/2 Gas LT	Left
APSAP050	Ø50 (2") L120	1/2 Gas LT	Left
APSAD050	Ø50 (2") L150	1/2 Gas LT	Left
APSA3055	Ø55 (2-5/32") L135	1/2 Gas LT	Left
APSAD060	Ø60 (2-23/64") L150	1/2 Gas LT	Left
APSAD080	Ø80 (3-3/64") L150	1/2 Gas LT	Left
APS8B100	Ø100 (4") L70	1/2 Gas LT	Left
APSDO105	Ø105 (4-1/6") L400	1/2 Gas LT	Left
APS8B140	Ø140 (5-33/64") L70	1/2 Gas LT	Left
<i>on request</i>	Ø105 (4-1/6") L70	1/2 Gas LT	Left
<i>on request</i>	Ø140 (5-33/64") L70	1/2 Gas LT	Left

GR

ES

CORE DRILLS - ELECTROPLATED

F=1/2Gas

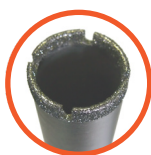
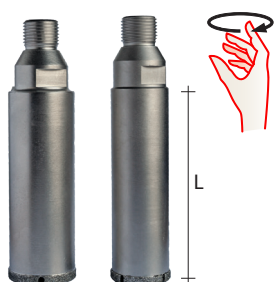

CODE	SIZE	FITTING	THREAD
APEA2025	Ø25 (1") L100	1/2 Gas LT	Left
EPE00001	Ø35 (1-3/8") L50	1/2 Gas LT	Left
APEA2036	Ø36 (1-27/64") L100	1/2 Gas LT	Left
APEA2062	Ø62 (2-7/16") L100	1/2 Gas LT	Left

MR

custom tools could be available on request

This is an example of the most used tools in 5 axis sculpture and architecture workings.
Lengths and diameters of the tools may vary depending on the specific work and machine type.

Tools for Cutting & Drilling

BLADE - HORIZONTAL Electroplated Both Side are Reinforced - F50+6 Holes



CODE	SIZE	REINFORCES	PRM	FEED
DME3395C ☺	Ø290 x 4 mm	9+9 L60	2200-2500	



EXTENSION for Horizontal Blades

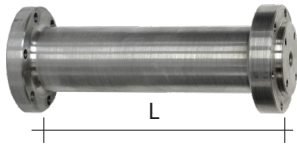

CODE	SIZE	FITTING
AZT2501A ☺	Ø45 L300 mm	from FLANGE (B50+6H) to FLANGE (D50+6 M6)
AZT0734A	Ø45 L207 mm	from FLANGE (B50+6H) to FLANGE (D50+6 M6)

CORE BITS - Electroplated



CODE	SIZE	RPM	FEED	DISTANCE
APE4i050 ☺	Ø50 L250 mm	2000-2500	60-120 mm/min	to drill initial hole
APE4i090	Ø90 L250 mm		2.4-4.8 inches/min	



CUTTING FINGERBIT - ELECTROPLATED - 1/2 GAS Fitting

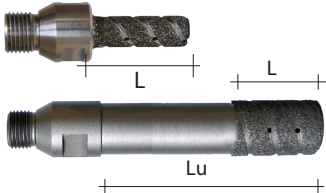

CODE	SIZE	RPM	FEED
AFE80010 ☺	Ø16 x 40 mm	4800-5500	250-500 mm/min
AFE80034	Ø20 x 80 mm		
AFE81015 ☺	Ø23 x Lu 155 mm		



FITTING 1/2 Gas > M12

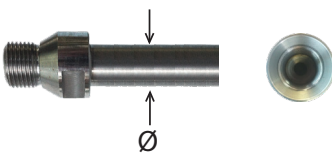

CODE	SIZE	THREAD	FITT MACHINE	FITT TOOL
AZT1518A ☺	Ø17 x 46 Lu60	Right	1/2 Gas	M12
AZT1518L ☺	Ø18 x 60 mm	Left	1/2 Gas	M12

REPLACEABLE TIPS - Electroplated



CODE	SIZE	FITTING	RPM	FEED
EFE00165 **	Ø20 x 22 mm	M12	4500-5200	250-500 mm/min 10-20 inches/min
EFE00184 * ☺	Ø20 x 20 mm	M12		



Tools for Recess

STUBBING WHEEL - Electroplated



CODE	SIZE	RPM	FEED	DISTANCE
AME00030	Ø85 x 20 mm	5000-5300	500-600 mm/min 20-24 inches/min	3-6 mm 0.12-0.24"



EXTENSION for Stubbing Wheel Ø85

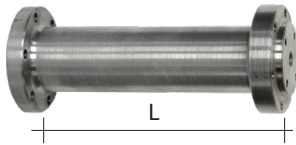

CODE	SIZE	FITTING
AZT2501A	Ø45 L300 mm	from FLANGE (B50+6H) to FLANGE (D50+6 M6)
AZT0734A	Ø45 L207 mm	from FLANGE (B50+6H) to FLANGE (D50+6 M6)

STUBBING WHEEL - ELECTROPLATED - Small diameter

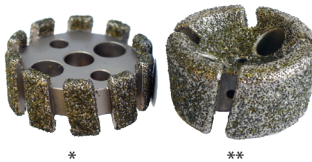

CODE	SIZE	FITTING	RPM	FEED
AME00020 * ☺	Ø50 x 20 mm	B10 - 2+2	4500-5000	250-500 mm/min
DSE1612E ** ☺	Ø50 x 20 mm	Ø10+2 holes	5500-6500	400-500 mm/min



EXTENSIONS FLANGE for small diameter Stubbing Wheels

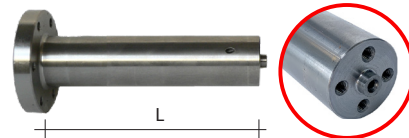

CODE	SIZE	FITT. MACHINE	FITT. TOOL
AZT1381A	Ø38 L224 mm	B50+6HØ6.5/63	Ø10 + 2 M6/25

FITTING 1/2 GAS > Flange -1-

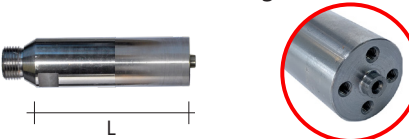

CODE	SIZE	THREAD	FITT MACHINE	FITT TOOL
AZT0765A ☺	Ø30 L30 mm	Right	1/2 Gas	Ø10 + 2 M6/25
AZT2513A	Ø30 L100 mm	Right	1/2 Gas	Ø10 + 2 M6/25

BALL HEAD MILLS - ELECTROPLATED

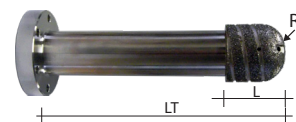

CODE	SIZE	GRIT	RPM	FEED	DISTANCE
AFE70013	Ø50 R20 L50 LT225	C	5000-6000	800-1000mm/ min	1-5 mm 0.04-0.20"
AFE70014	Ø50 R20 L50 LT225	M			



Tools for Sculpting & Carving

MAIN FINGERBITS - Conic with replaceable Tips

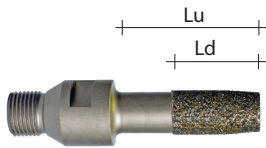

CODE	SIZE	RPM	FEED
AFE40060	Ø18/20 Ld60 Lu60 mm	6000 - 7000	400 - 800 mm/min
AFE42002**	Ø14/18 Ld25 mm R6 - 4.57°	D602	



CONIC MILL - HARD METAL TG6* - 1/2 Gas - For FINISHING

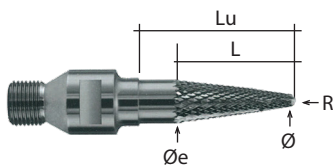

CODE	Ø	Øe	R	L	Lu	RPM	FEED
AFW40350 ☺	5	12	2.5	48	50		
AFW40370 ☺	5	16	2.5	80	103		



CONIC MILLS - WIDIA - 10 mm Shank - For CARVING MARBLE (minimum order: 5 pcs)

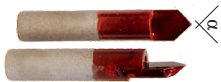

CODE	SIZE	RPM	FEED
AFW60010 ☺	Ø10 x 5 mm - α90°		



ENGRAVING MILLS - Flat Head (no internal cooling) - Electroplated - 6 mm Shank - (minimum order: 5 pcs)

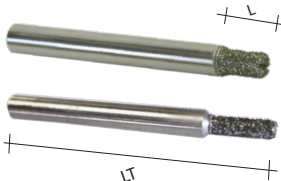

CODE	SIZE	RPM	FEED
AFE00016	Ø4 L12 LT60 mm		
AFE00021	Ø5 L12 LT60 mm		
AFE00030	Ø6 L12 LT90 mm		
AFE00065	Ø10 L12 LT90 mm		



*... also available many others tools for 5 axis, adapttors, pliers ...
see page A90 for ERG20/ERG32 Kits*



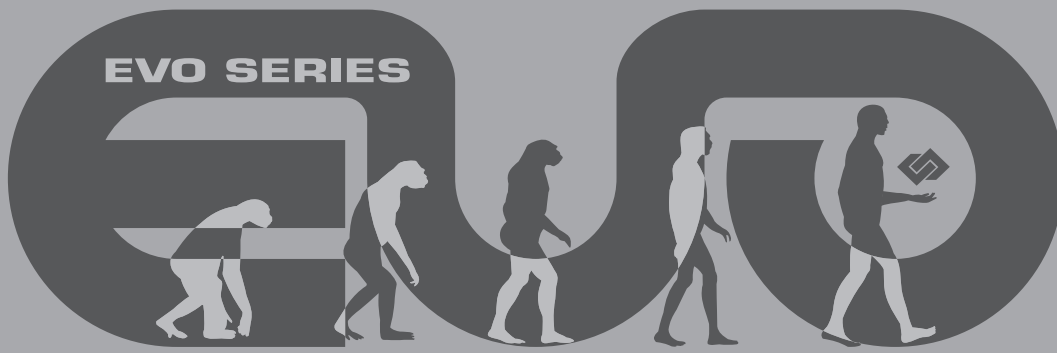

*** EVOLUTIONARY NEW BOND FOR LONGER LIFE ***

*** VERY ACCURATE MEASURING SYSTEM ***

*** PERFECT NUMBERS ON THE BOX EASY SET UP ***



SOLUTION

WITH FIVE DIAMOND WHEELS

XF

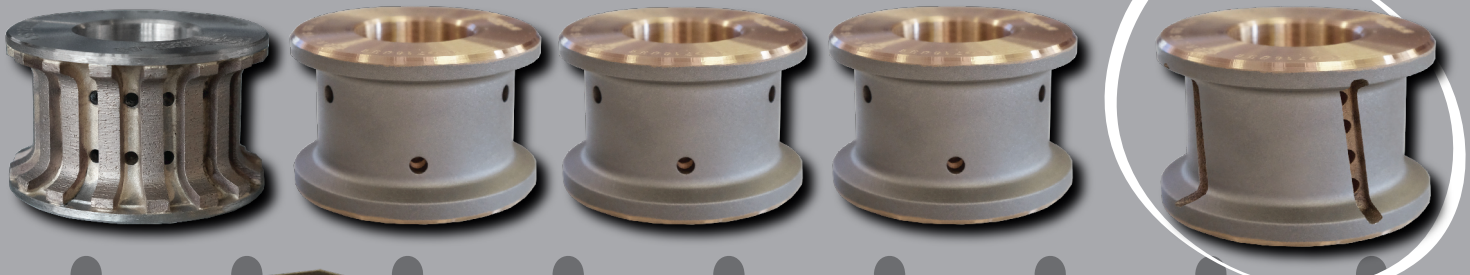

Very High Precision measuring system

Zares 3D view technology allow to acquire the tool images analyzing the geometric consistency of the diamond tools.

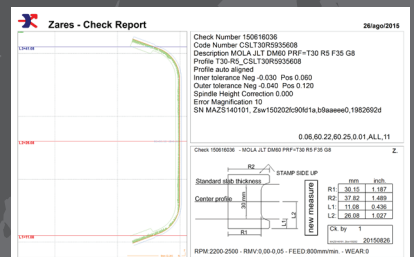
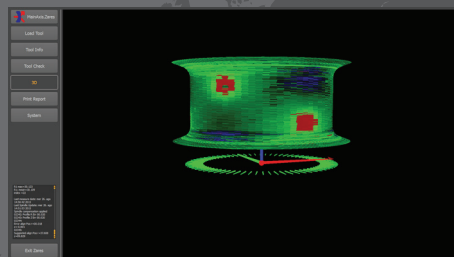
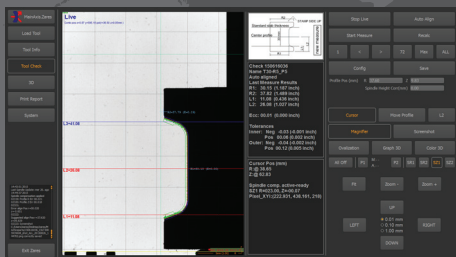

Every NICOLAI DIAMANT wheel is certified with Zares

www.zares.it

Tools for 5 axis and Robots

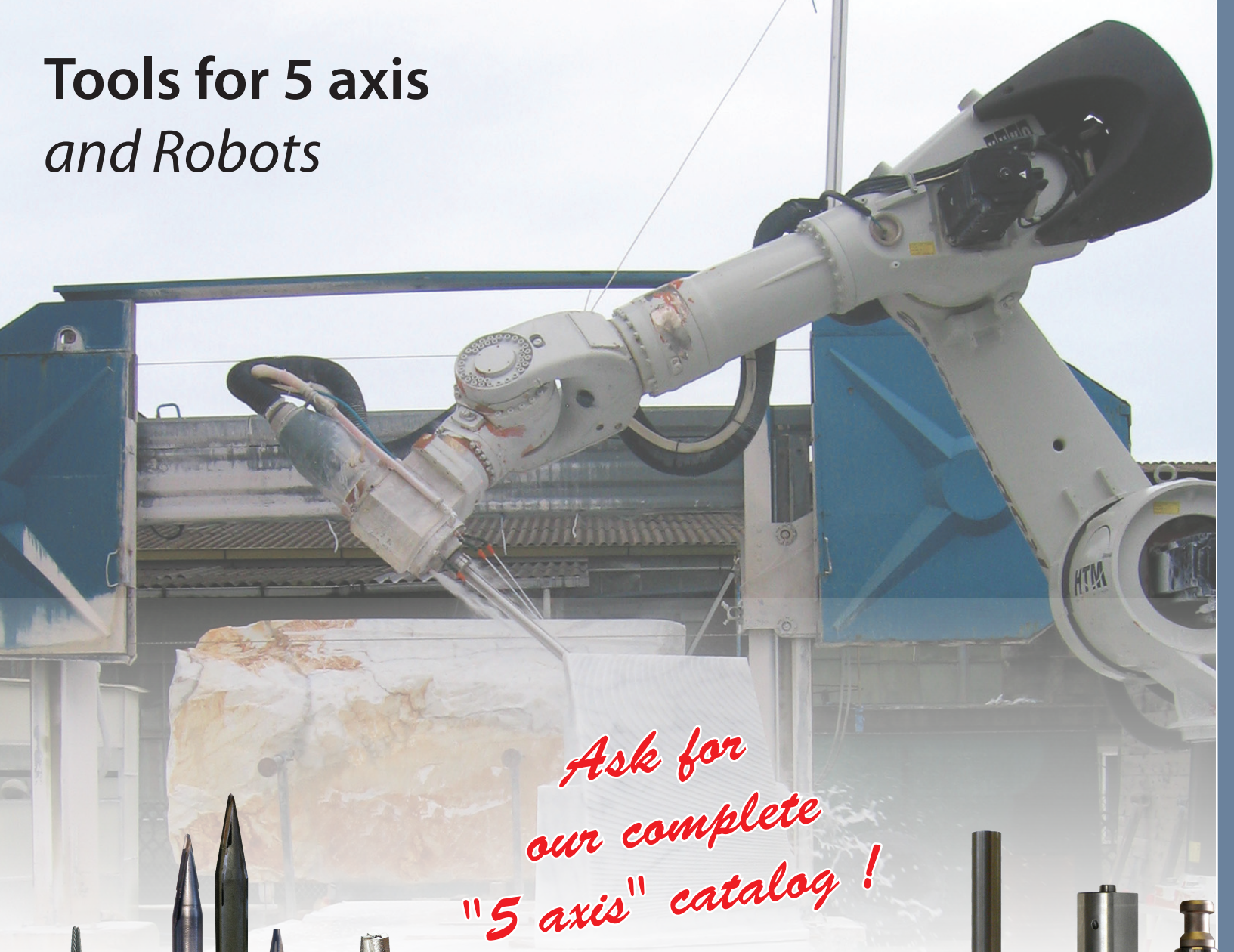

*Ask for
our complete
"5 axis" catalog !*



Full range of widia, pcd,
electroplated and synthered
mills for roughing, sculpting, finishing...

Adapters
Extensions
Cones



Full range of
stubbing wheels and profiling wheels





EDGE WORKING tools



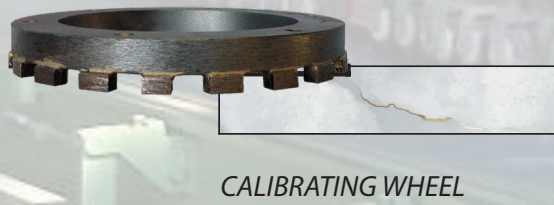
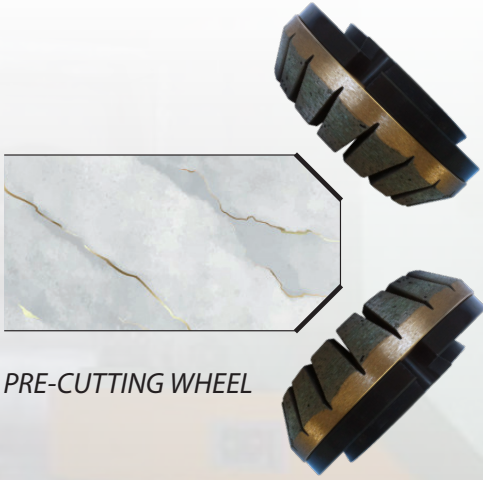



- 1 -



*Pre Cut Wheel
(Turbo)*

- 2 -



*Double Side Turbo
Pre Cut Wheel*

- 3 -

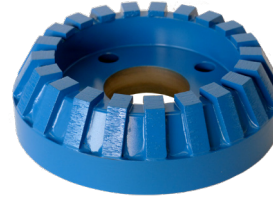

*Pre Cut Wheel
Segmented*

- 4 -



*Double Side Seg
Pre Cut Wheel*

- 5 -



*Generating
Conic Frontal Wheel*

- 6 -



Flat Wheel

- 7 -



Calibrating Wheel

- 8 -



Diamond Blade

	DESCRIPTION	CODE	SIZE	FITTING	MODEL
- 1 -	PRE CUT WHEELS	ACSZ1551	Ø155x25 60°	M30	LARA 40s / LARA 60s / LARA 80s / LUNA
		ACSZ1602	Ø130x18 60°	M30	LARA 40s / LARA 60s
- 2 -	DOUBLE SIDE TURBO PRE CUT WHEELS	ACSZ1802	Ø130x34 60°x2	M30	LARA 80 / LARA 60 / LUNA 740
- 3 -	PRE CUT WHEELS SEGMENTED	ACSY1606	Ø150x20 60°	M30	LARA 40s / LARA 60s / LARA 80s / LUNA
		ACSY1603	Ø130x18 60°	M30	LARA 40s / LARA 60s
- 4 -	DOUBLE SIDE SEG PRE CUT WHEEL	ACSY1605	Ø150x20+15 60°	M30	LARA 40s / LARA 60s / LARA 80s / LUNA
- 5 -	GENERATING CONIC FRONTAL WHEELS	ACF3304S	Ø130x47,5 60°	M30	LARA 40s / LARA 60s
		ACF4304S	Ø155x60 60°	M30	LUNA 740
		ACFH304S	Ø155x60x5	M30	All machines new machine
		ACFH30SU	Ø155x60 DoubleGrit	M30	All machines new machine
- 6 -	FLAT WHEELS	EMS00094	Ø250x6	B50+4HØ9/90	All machines
		EMS00089	Ø250x8	B50+4HØ9/90	All machines
		EMS00091	Ø250x10	B50+4HØ9/90	All machines
- 7 -	CALIBRATING WHEELS	DSS3830S	Ø200	B50+4HØ9/90+4HØ9/125	Optional for all machines
		ECS00002	Ø200	B50+4HØ9/90	All machines
		DSS3884S	Ø250	B50+4HØ9/90	Optional for LARA / LUNA 740
- 8 -	DIAMOND BLADES	D25QNEY151044M	Ø250x4,4	B50+4HØ9/125	LARA 80 / LARA 80s / UNICA 810-4a
		D300LMV181044M	Ø300x4,4	B50+4HØ9/125	LARA 80 / LARA 80s / UNICA 810-4a
		D250SG6301026M	Ø250x2,6	B50+4HØ9/125	VIVA 220 V-Groove
		D260SG6301026M	Ø260x2,6	B50+4HØ9/125	VIVA 220 V-Groove

All original manufacturer names and brands are used for identification purposes only.

** trademark property of MONTRESOR s.r.l.*

Nicolai Diamant s.r.l. is not affiliated with MONTRESOR s.r.l.

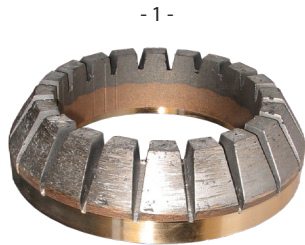

Pre Cut Wheels

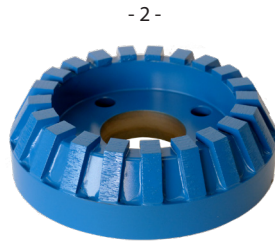

Pre Cut Wheel Segmented

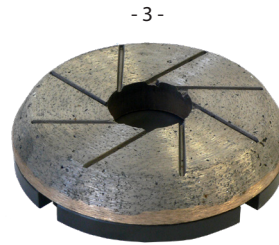

Generating Conic Frontal Wheel



Chamfering Wheel

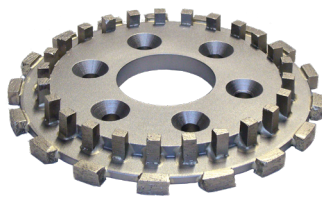

Flat-Calibrating Wheel



Flat Wheel

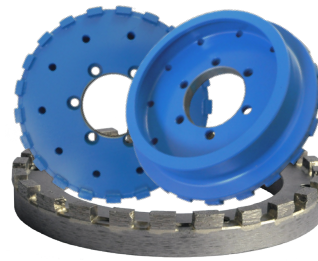

Calibrating Wheel



Diamond Blade

	DESCRIPTION	CODE	SIZE	FITTING	MODEL
- 1 -	PRE CUT WHEELS	ACSZ1600	Ø130x18 60°	B95+6M6/115 (**)	TE / TE Experience / FULL / RCM
		ACSZ1601	Ø130x18 60°	SNAIL	TE / RCM
- 2 -	PRE CUT WHEELS SEGMENTED	DSS3362S	Ø106x20 70°	B65+6M6/80	
- 3 -	GENERATING CONIC FRONTAL WHEELS	ACF3004S	Ø130x47	B95+6M6/115 (**)	TE / TE Experience / FULL / RCM
		ACF3SN4S	Ø130x47	SNAIL	TE / TE Experience / FULL / RCM
- 5 -	FLAT-CALIBRATING WHEELS	DSS2593S	Ø160x6+Ø130x10	B50+6HØ9/80	TE / TE Experience / FULL / RCM
		DSS1189S	Ø160x8+Ø130x10	B50+6HØ9/80	TE / TE Experience / FULL / RCM
- 4 -	CHAMFERING WHEEL	DSG32653	Ø125x25	B95+6M6/115 (**)	
- 6 -	FLAT WHEELS	DSS3389S	Ø160x5	B50+6HØ9/80	TE / TE Experience / FULL
		EMS00057	Ø160x8	B50+6HØ9/80	TE / TE Experience / FULL
		DSS1188S	Ø200x8	B30	TE
- 7 -	CALIBRATING WHEELS	DSS0294S	Ø130	B95+6M6/115 (**)	TE / TE Experience / FULL
		DSS4143S	Ø130	B50+6HØ9/80	TE / TE Experience / FULL
		DSS3183S	Ø180	B58+6HØ9/72	CDF
	DIAMOND BLADES	D200NG6130640M	Ø200x4	B40	CDF / FULL
		D230NEY151030M	Ø230x3	B40	CDF / FULL
- 8 -	ELECTROPLATED DIAMOND BLADES	EDE00016	Ø160x7	B58+6HØ9/72	CDF
		SNAIL LOCK FITTING	AZT1196A	Ø100	SNAIL > Ø95+6HØ7/115

(**): requires snail fitting AZT1196A

All original manufacturer names and brands are used for identification purposes only.

* trademark property of SASSOMECCANICA s.r.l.

Nicolai Diamant s.r.l. is not affiliated with SASSOMECCANICA s.r.l.

profiling wheels could be available on request

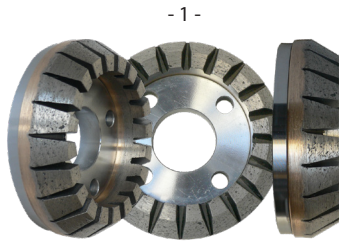

Pre Cut Wheels
G1-G2

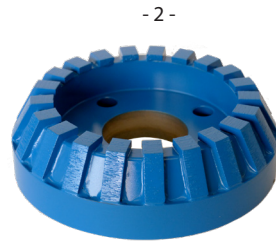

Pre Cut Wheel
Segmented
G1-G2

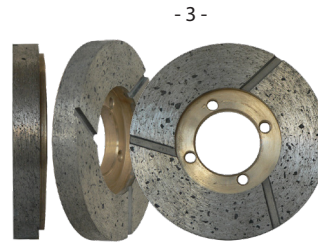

Generating
Frontal Wheel
(Speedy System)

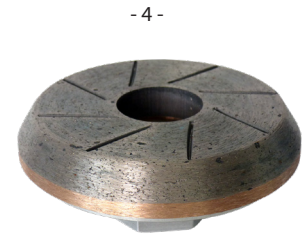

Generating
Conic Frontal Wheel
G3



Segmented Diamond Wheel



Flat Wheel



Calibrating Wheel



Diamond Blade

	DESCRIPTION	CODE	SIZE	FITTING	MODEL
- 1 -	PRE CUT WHEELS	ACSZ1550	Ø155x25 60°	B50+4HØ12,5/85	PNC / SYNTHESIS / OMEGA
- 2 -	PRE CUT WHEELS SEGMENTED	ACSY1602	Ø155x20 60°	B50+4HØ12,5/85	PNC / SYNTHESIS / OMEGA
- 3 -	GENERATING FRONTAL WHEELS (Speedy System)	ACF6004S	Ø120x27,5+10	M24	NEW SYSTEM / SPEEDY SYSTEM
		ACFFF14S	Ø120x27,5+5	B40+4HØ7/50	NEW SYSTEM / ATHENA / SPEEDY S.
		ACF6F14S	Ø120x27,5+10 TZ1	B40+4HØ7/50	NEW SYSTEM / ATHENA / SPEEDY S.
		ACF6F14U	Ø120x27,5+10 TZ2	B40+4HØ7/50	NEW SYSTEM / ATHENA / SPEEDY S.
	ACF1184S	Ø120x35	M18	SYSTEM	
- 4 -	GENERATING CONIC FRONTAL WHEEL	ACF3304S	Ø130x47,5	M30	PNC / OMEGA
- 5 -	SEGMENTED DIAMOND WHEEL	DSS2970S	Ø150x20 R10	B40+4HØ7/50	NEW SYSTEM
- 6 -	FLAT WHEELS	EMS00066	Ø260x8	B50+4HØ12,5/95	EDILUX / PNC
		EMS00116	Ø260x10	B50+4HØ12,5/95+4HØ9/135	
		EMS00067	Ø300x8	B50+4HØ9/135	EDILUX / PNC
- 7 -	CALIBRATING WHEELS	DSS3772S	Ø190	B50+4HØ12,5/95	MUSA / ALMA / PENTA
		DSS1654S	Ø260	B50+4HØ12,5/95	EDILUX / PNC / OMEGA
- 8 -	DIAMOND BLADES	ADS01002	Ø150x3,6	B30+4HØ9/45	SYSTEM PLUS
			Ø200x3,6	B50+4HØ9/135	EDILUX / PNC / OMEGA / SYNTHESIS
		D250SEY171032C	Ø250x3,2	B50+4HØ12,5/95+4HØ9/135	EDILUX / PNC / OMEGA / ALMA

All original manufacturer names and brands are used for identification purposes only.
*trademark property of COMANDULLI s.r.l.
Nicolai Diamant s.r.l. is not affiliated with COMANDULLI s.r.l.



profiling wheels Ø260 could be available on request



- 1 -



Pre Cut Wheels

- 2 -



Pre Cut Wheel Segmented

- 3 -



Generating Conic Frontal Wheel

- 4 -



Chamfering Wheel

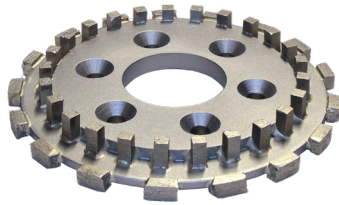

Flat-Calibrating Wheel

- 5 -



Flat Wheel

- 6 -



Calibrating Wheel

- 7 -

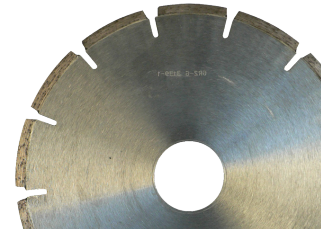

Diamond Blade

- 8 -

DESCRIPTION	CODE	SIZE	FITTING	MODEL
- 1 - PRE CUT WHEELS	ACSZ1601	Ø130x18 60°	SNAIL	
	ACSZ1600	Ø130x18 60°	B95+6M6/115 (**)	
- 2 - PRE CUT WHEELS SEGMENTED		Ø130x18 60°	SNAIL	
		Ø130x18 60°	B95+6M6	
- 3 - GENERATING CONIC FRONTAL WHEELS	ACF3SN4S	Ø130x47.5	SNAIL	
	ACF3004S	Ø130x47.5	B95+6M6/115 (**)	
- 6 - FLAT-CALIBRATING WHEEL	DSS1189S	Ø160x8+Ø130x10	B50+6Ø9/80	
- 4 - CHAMFERING WHEELS	DSG3265C	Ø125x25	SNAIL	
	DSG32653	Ø125x25	B95+6M6/115 (**)	
- 5 - FLAT WHEELS	AMS10026	Ø200x8	B50+6HØ9/80+4HØ11/120	
	AMS10521	Ø300x8	B50+6HØ9/80+4HØ11/120	
- 7 - CALIBRATING WHEEL	DSS0294S	Ø130	B95+6M6/115 (**)	
- 8 - DIAMOND BLADES	D300LMV3610400	Ø300x4 SIL	B50	
	HF05004D111200		B50+4HØ11/120	

(**): requires snail fitting AZT1196A

All original manufacturer names and brands are used for identification purposes only.

* trademark property of GMM s.p.a.

Nicolai Diamant s.r.l. is not affiliated with GMM s.p.a.



- 1 -



Pre Cut Wheel

- 2 -



Double Side Segmented
Pre Cut Wheel

- 3 -



Generating
Conic Frontal Wheel



Tiger Conic Frontal Wheel



Flat Wheel



Calibrating Wheel

- 4 -

- 5 -

- 6 -

	DESCRIPTION	CODE	SIZE	FITTING	MODEL
- 1 -	PRE CUT WHEELS	ACSZ1603	Ø130x18 60°	M24	LCT - LTH - LTZ - LTN - LTV
- 2 -	DOUBLE SIDE PRE CUT WHEELS SEGMENTED	ACSZ1803	Ø130x34 60°x2	M24	LCT - LTH
- 3/4 -	GENERATING CONIC FRONTAL WHEELS BULLNOSE SHAPING	ACF4244S	Ø155x60 60°	M24	LTH - LTZ
		ACF3244S	Ø130x47 60°	M24	LCT - LTN - LTV
- 5 -	FLAT WHEELS	AMS10220	Ø250x8	B50	LCV - LCH - LCT - LTV - LTN - LTH - LTZ
		AMS10230	Ø250x10	B50	
- 6 -	CALIBRATING WHEEL	DSS4585S	Ø250	B50	

All original manufacturer names and brands are used for identification purposes only.
* trademark property of Marmo Meccanica s.p.a.
Nicolai Diamant s.r.l. is not affiliated with Marmo Meccanica s.p.a.

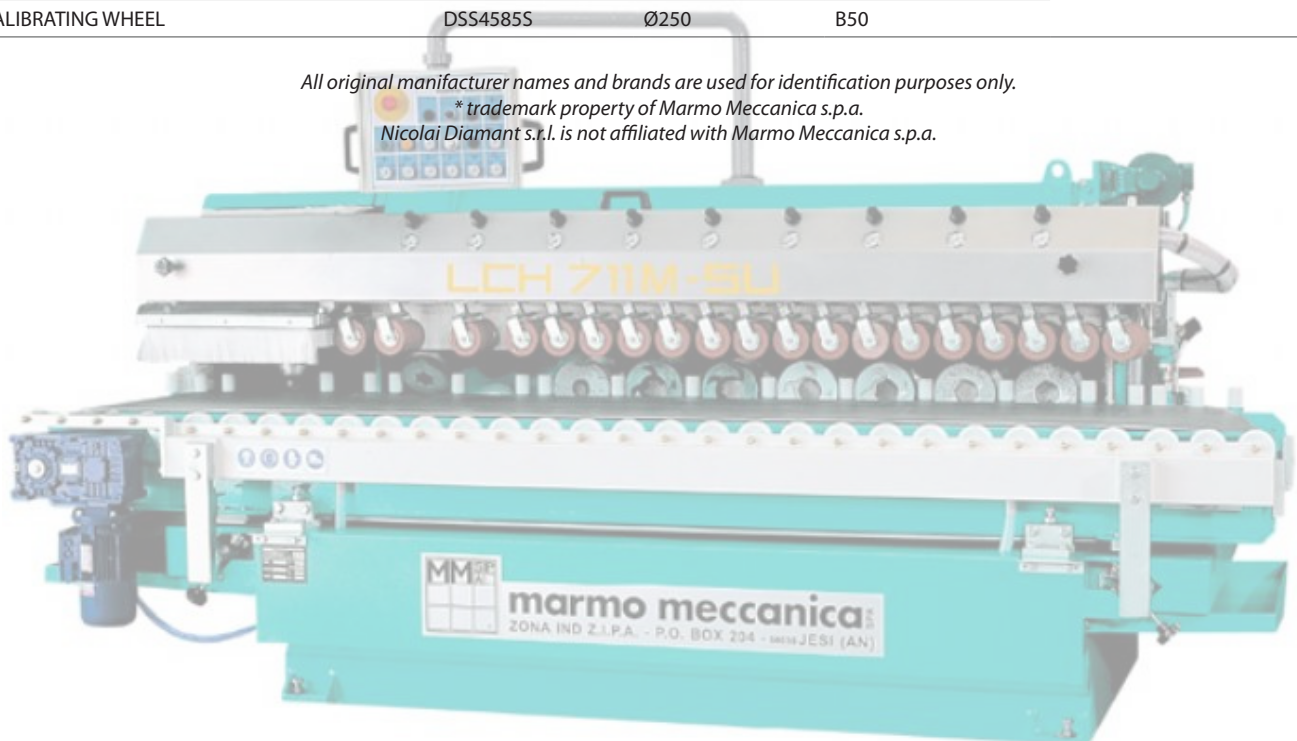



Pre Cut wheel
Segmented

- 1 -



Conic frontal wheel
bullnose shaping

- 2 -



Calibrating wheel

- 3 -

	DESCRIPTION	CODE	SIZE	FITTING	MODEL
- 2 -	CONIC FRONTAL WHEEL BULLNOSE SHAPING	ACF4BE4S	D148x60x3.5	D145+3M6	
- 3 -	CALIBRATING WHEEL	DSS4135S	D138	F30	COMET - NUOVA MODULO / SUPER MODULO
- 1 -	D150 PRE CUT WHEELS SEGMENTED	ACSY1607	D150x23-60°	D145+3M6	
- 1 -	D130 PRE CUT WHEELS SEGMENTED	ACSY1706	D130x14-45°	D125+3M6	

All original manufacturer names and brands are used for identification purposes only.

* trademark property of GMM s.r.l.

Nicolai Diamant s.r.l. is not affiliated with GMM s.r.l.





- 1 -



Pre Cut wheel
Segmented

- 2 -



Conic frontal wheel
bullnose shaping



Calibrating wheel



Diamond blade

- 3 -

- 4 -

	DESCRIPTION	CODE	SIZE	FITTING	MODEL
- 1 -	PRE CUT WHEELS SEGMENTED	ACSY1708	D130x14-45°	M20	
- 2 -	CONIC FRONTAL WHEEL BULLNOSE SHAPING	ACF32A4S	D130x47-60°	M24	
- 3 -	CALIBRATING WHEEL	DSS3703S	D150	M24SX	
- 4 -	DIAMOND BLADE	D250NEY171030M	D250		
		HF05006D070750		B50+6HØ7/75 TSEI	

All original manufacturer names and brands are used for identification purposes only.
* trademark property of Cavani Meccanica s.r.l.
Nicolai Diamant s.r.l. is not affiliated with Cavani Meccanica s.r.l.





- 1 -



Pre Cut Wheel Segmented

- 2 -

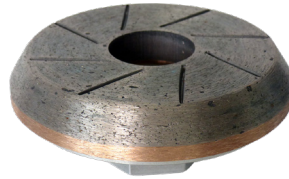

Conic frontal wheel bullnose shaping



Flat wheel



Calibrating wheel



Diamond blade

- 3 -

- 4 -

	DESCRIPTION	CODE	SIZE	FITTING	MODEL
- 1 -	PRE CUT WHEELS SEGMENTED	DSS22185	D250	F50+4+4	LA80 - MINI60
		ACSY2300	D150	F50+4	MINI60
- 2 -	CONIC FRONTAL WHEEL BULLNOSE SHAPING	ACF4CM45	D150	SNAIL	
- 3 -	CALIBRATING WHEEL	ACS20026	D250	*****	LA80 - LP100 - MINI60
- 4 -	DIAMOND BLADE	D250NEY171030M	D250		LA80 - LP100 - MINI60
		HF05004D111300		B50+4+4	

All original manufacturer names and brands are used for identification purposes only.
 * trademark property of CMPI s.r.l.
 Nicolai Diamant s.r.l. is not affiliated with CMPI s.r.l.

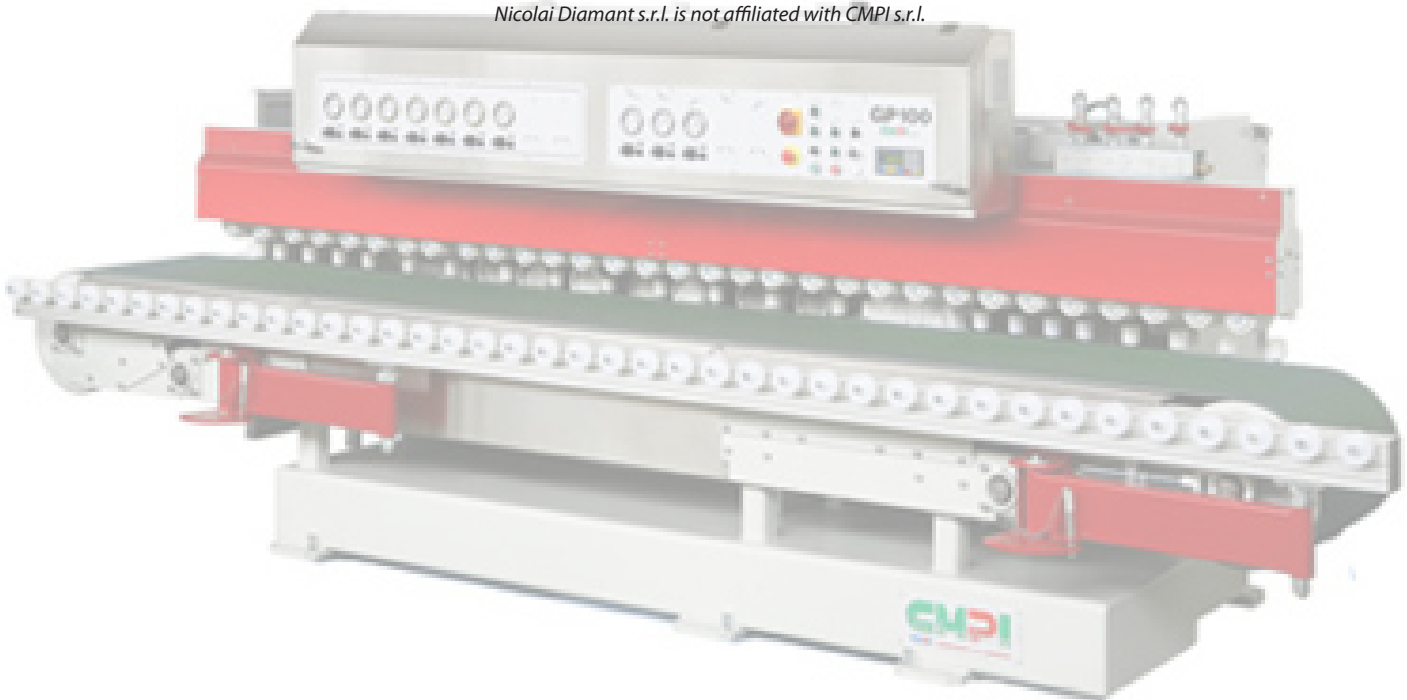



- 1 -

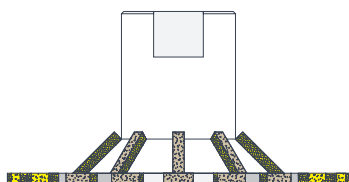

Segmented pre-cutting wheel

- 2 -



Conic frontal wheel bullnose shaping

- 3 -



Grooving wheel



Calibrating Wheel

- 4 -



Diamond blade

- 5 -

	DESCRIPTION	CODE	SIZE	FITTING	MODEL
- 1 -	PRE CUT WHEELS SEGMENTED	DSS4765S	D150	M30	
- 2 -	CONIC FRONTAL WHEELS BULLNOSE SHAPING	*****	D150	M30	
		ACF3CM4S	D130	M30	
- 3 -	GROOVING WHEEL	*****	D200	B50	
- 4 -	CALIBRATING WHEEL	ACS2005S	D200	B50+6	
- 5 -	DIAMOND BLADE	D250NEY171030M	D250	B50+6	

All original manufacturer names and brands are used for identification purposes only.
 * trademark property of CMG s.r.l.
 Nicolai Diamant s.r.l. is not affiliated with CMG s.r.l.

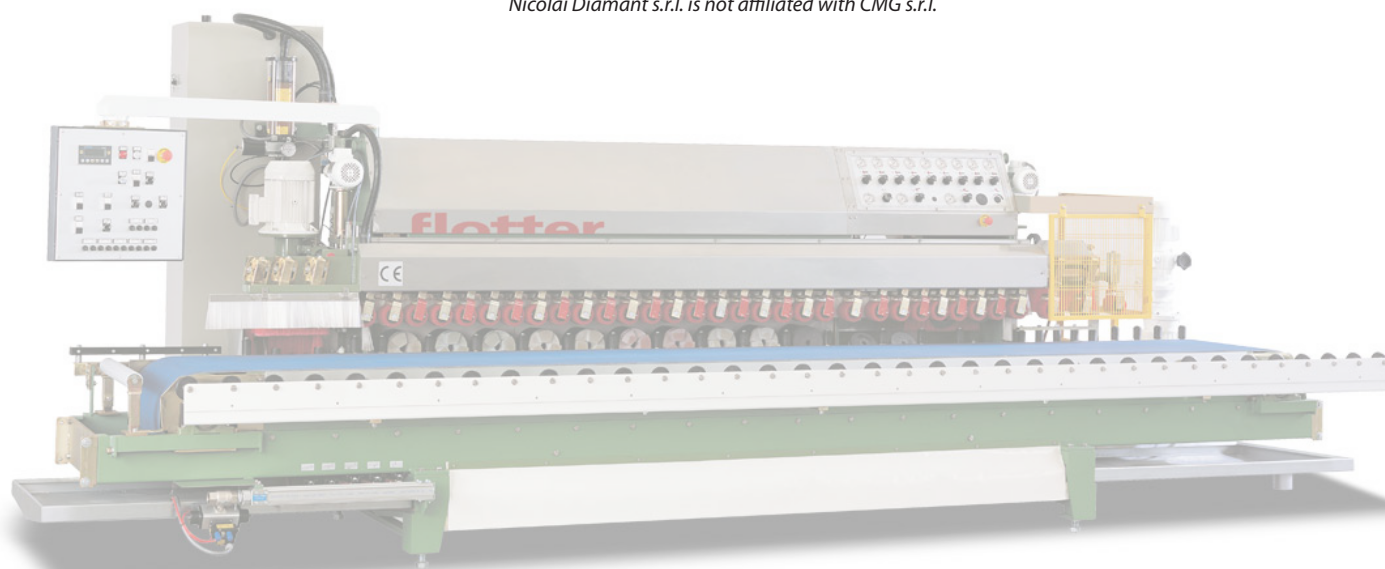

- 1 -



*Turbo
Pre-Cutting Wheel*

- 2 -



*Generating
Conic Frontal Wheel*



Calibrating Wheel

- 3 -



Diamond blade

- 4 -

	DESCRIPTION	CODE	SIZE	FITTING	MODEL
- 1 -	PRE CUT WHEELS	ACSZ1604	Ø130x18 60°	B120	CTB PLATINUM
	PRE CUT WHEEL SEGMENTED	DSS4217S	Ø170x18 60°	B50+4HØ8/120	CTB PLATINUM
- 2 -	GENERATING CONIC FRONTAL WHEELS	ACF3BR4S	Ø130x47.5	M30 x1.5	CTB PLATINUM
		DSS3759S	Ø170x35	B50+4HØ8/120	EASY EDGE
	FLAT WHEELS	D250NEY171026F	Ø250x2.6	B30	CTB PLATINUM
		on request	Ø250x4.4	B30	CTB PLATINUM
		on request	Ø250x6	B30	CTB PLATINUM
- 3 -	CALIBRATING WHEELS	DSS4605S	Ø250 Z20 20x10x7	B50+4HØ9/85	CTB PLATINUM
		DSS3854S	Ø170	B50+4HØ8/120	EASY EDGE
- 4 -	DIAMOND BLADES	D250SEY171032S	Ø250x3.2	B50+4HØ9/85	CTB PLATINUM
		D250LMV301044A	Ø250x4.4	B50+4HØ9/120	EASY EDGE
	PROFILING WHEEL	AMS14016	Ø250X10	B50+4HØ9/120	EASY EDGE

All original manufacturer names and brands are used for identification purposes only.

** trademark property of BRETON s.p.a.*

Nicolai Diamant s.r.l. is not affiliated with BRETON s.p.a.

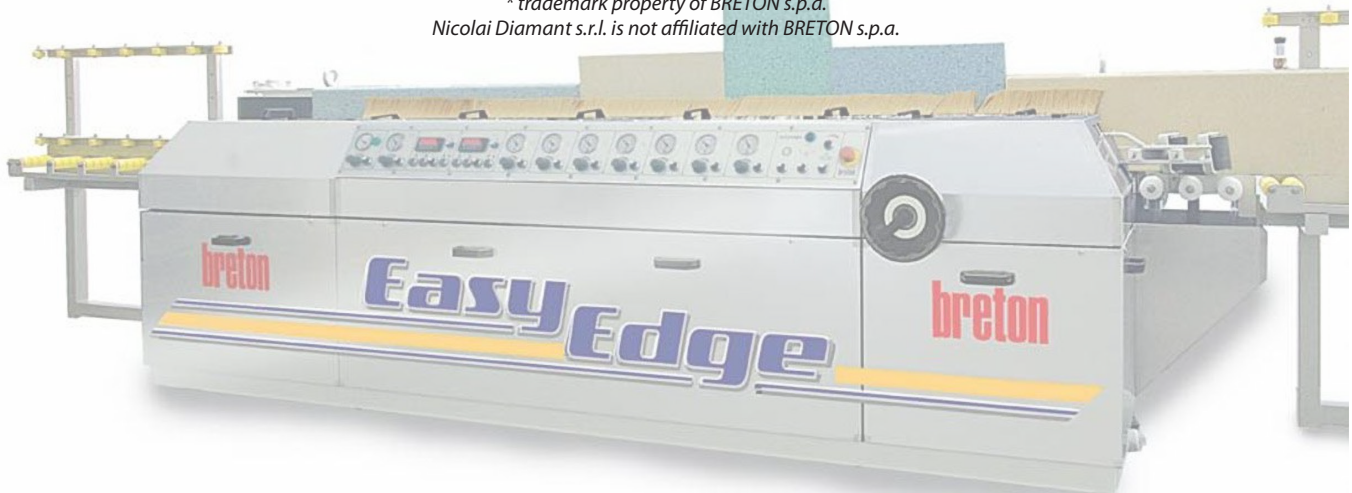

FRONTAL WHEELS

edge working tools



FRONTAL WHEELS

Continuous Rim for Single Head Edge Polishing Machines



Ø150 x 50 mm

CODE	SIZE	FITTING	MACHINES
ACF2004S	Ø100 x 35 mm	NONE	
ACF2144S	Ø100 x 35 mm	M14	
ACF2184S	Ø100 x 35 mm	M18	Denver / Prussiani
ACF2204S	Ø100 x 35 mm	M20	Cavani
ACF2SN4S	Ø100 x 35 mm	SNAIL	
ACF1004S	Ø125 x 37,5 mm	NONE	
ACF1184S	Ø125 x 37,5 mm	M18	Comandulli / Denver
ACF1224S	Ø125 x 37,5 mm	M22	
ACF1244S	Ø125 x 37,5 mm	M28	
ACF1SN4S	Ø125 x 37,5 mm	SNAIL	
ACF7304S	Ø130 x 45 mm	B30	
ACF7F24S	Ø130 x 45 mm	B95+6M6/115	
ACF5004S	Ø150 x 50 mm	B50+3M6/110	
ACF5244S	Ø150 x 50 mm	M24 x3	
ACF5304S	Ø150 x 50 mm	M30	
ACF5SN4S	Ø150 x 50 mm	SNAIL	

FRONTAL WHEELS

Continuous Rim w/ Reinforced side for Comandulli Speedy System

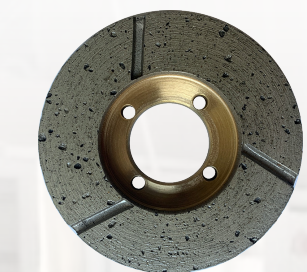

CODE	SIZE	S	FITTING	MACHINES
ACF6004S	Ø120 x 27.5	10 mm	M24	Comandulli Speedy System
ACF6F14S	Ø120 x 27.5 TZ1	10 mm	B40+4HØ6.5/50	Comandulli Speedy System
ACF6F14U	Ø120 x 27.5 TZ2	10 mm	B40+4HØ6.5/50	Comandulli Speedy System
ACFFF14S	Ø120 x 27.5	5 mm	B40+4HØ6.5/50	Comandulli Speedy System

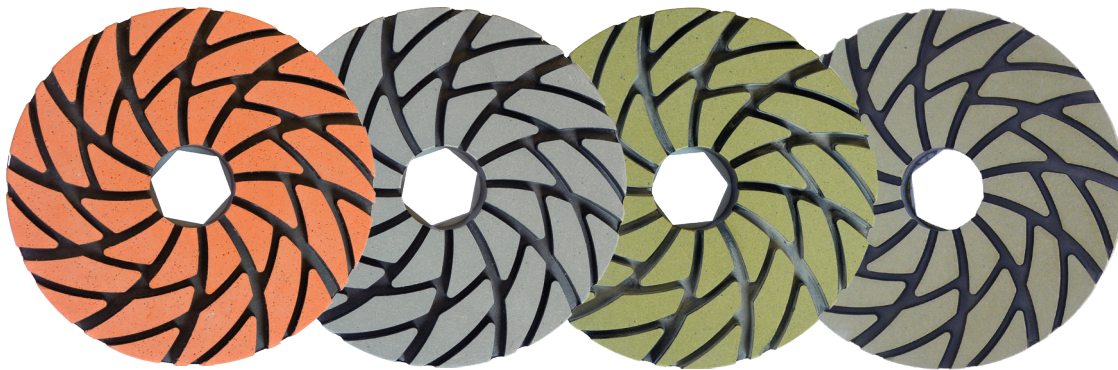

FEATURES

- Polish equally well on natural stone, engineered stone, bull nose, flat, bevel
- no need to change wheel's type
- long life & good finish

ADVANTAGES

- Life of position 1 and 2 is presently 8 to 10 times the life of the best bricks. Resimetal is even longer, almost twice
- No need to change wheels for bull nose, flat, natural, engineered granite.
- These wheels work well on all shapes and all materials, natural or engineered, , and from very soft to very hard (Ruby Red) granites

TIPS

- It is not necessary to "double up" from 200 to 400 to 800 etc. Customers have used 600 to 1500 or used 1800 instead of 1500, it really matters very little. The wheels are very aggressive, but still give a very good finish.
- **Position 1 wheels:** a coarse 60/80 mesh wheel works best as it removes completely the lines LT by the metal bond shaping wheel. Keep the pressure low for better finish and much longer life. Using pressure higher than 2 will cause wheel marks that the next wheel will have problems removing
- **Finish:** the conventional brick LUX gives the best finish on the last position on natural dark granite colors. Engineered Stone: 60/80, 100, 200, 400, 600, 1500 (no LUX), speed 40 or 45cm/min. The finish on engineered material is good enough on all materials except Space Black, where the LUX is better. On space black reduce speed to 35 and use a LUX brick.
- **Shape of bull nose:** if the bull nose comes out "pointed" that is because the pos. 1 wheel stays too long on the stone and cuts too much. The solution is to go faster
- **Position 1 leaves wheel marks:** too much pressure
- **Polish not shiny enough** (does not match top): need BUFF wheels. Best is a iGLOO BLACK BUFF for natural granite, a iGLOO WHITE BUFF for engineered granite and for marble.

MACHINES

- Tested and approved for: Comandulli, CMG, CMPI, Montresor, Marmo meccanica, GMM-Cemar, Sassomeccanica, Park Industries



ABRACADABRA SUPREME ECO

Resin Polishing Wheels for GRANITE & ENGINEERED STONE



GRIT	CODE Ø130 (5")	CODE Ø150 (6")
60/80	CLRLL08A	CLRLL080
100	CLRLL10A	CLRLL100
200	CLRLL20A	CLRLL200
400	CLRLL40A	CLRLL400
600	CLRLL60A	CLRLL600
800	CLRLL80A	CLRLL800
1500	CLRLL15A	CLRLL150
3500	CLRLL35A	CLRLL350
5000	CLRLL50A	CLRLL500



ABRACADABRA BEVEL

Resin Polishing Wheels for GRANITE & ENGINEERED STONE

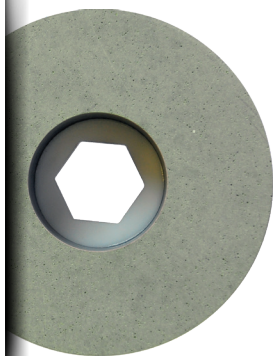

GRIT	CODE Ø125 (5")	
220	CLR20001	Machines with two bevels use grit 400-800
400	CLR20004	
600	CLR20006	
800	CLR20002	



ABRACADABRA is a new diamond ceramic wheel that it is proving to be very versatile and appreciated by the customers that have used them. It can polish equally well on natural stone, engineered stone, bull nose, flat, bevel, without the need to change wheel's type. **It is very aggressive, has long life and gives a good finish**

Advised for flat, bevel and bullnose:



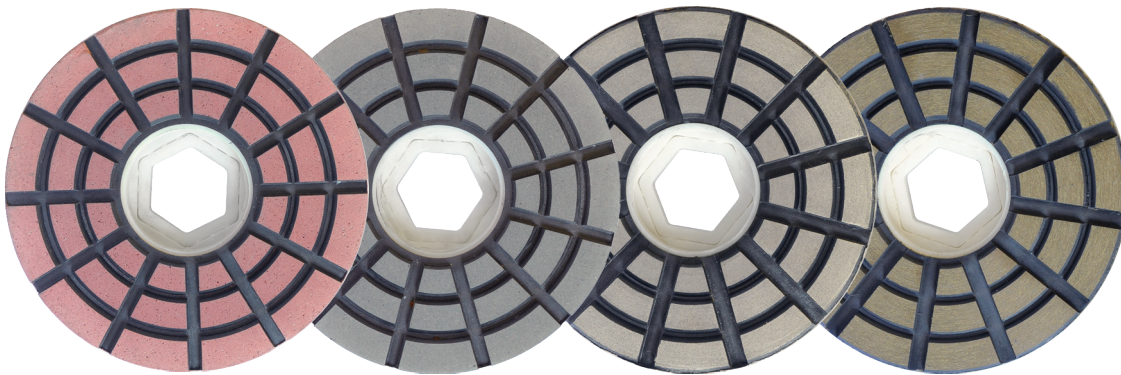

FEATURES

- Polishes equally well flat edge of natural stone and engineered stone
- no need to change wheel's type
- long life & good finish

ADVANTAGES

- Life of position 1 and 2 is presently 8 to 10 times the life of the best bricks. Resimetal is even longer, almost twice
- No need to change wheels for natural and engineered granite.
- These wheels work well on all materials, natural or engineered, and from very soft to very hard (Ruby Red) granites

TIPS

- It is not necessary to "double up" from 200 to 400 to 800 etc. Customers have used 600 to 1500 or used 1800 instead of 1500, it really matters very little. The wheels are very aggressive, but still give a very good finish.
- **Position 1 wheels:** a coarse 60/80 mesh wheel works best as it removes completely the lines LT by the metal bond shaping wheel. Keep the pressure low for better finish and much longer life. Using pressure higher than 2 will cause wheel mark that the next wheel will have problems removing
- **Finish:** the conventional brick LUX gives the best finish on the last position on natural dark granite colors.
Engineered Stone: 60/80, 100, 200, 400, 600, 1500 (no BUFF), speed 40 or 45cm/min.
The finish on engineered material is good enough on all materials except Space Black, where the LUX is better.
On space black reduce speed to 35 and use a BUFF tool.
- **Position 1 leaves wheel marks:** too much pressure
- **Polish not shiny enough** (does not match top): need BUFF polishing wheels. Best is a iGLOO BLACK BUFF for natural granite, a iGLOO WHITE BUFF for engineered granite and for marble.

MACHINES

- Tested and approved for: Comandulli, CMG, CMPI, Montresor, Marmo meccanica, GMM-Cemar, Sassomeccanica, Park Industries

Each customer will find the sequence that fits his requirements best, what follows is a guideline and a staRT up:
Flat edge: 4 HEADS (200,400,800,1500) - 5 HEADS (100,200,400,800,1500) - 6 HEADS (100,200,400,800,1500,3000)
 7 HEADS (60/80,100,200,400,800,1500,3500) - 8 HEADS (60/80,100,200,400,600,800,1500,3500)
 10 HEADS (60/80,100,200,400,400,600,800,1500,3500,5000)

ABRACADABRA EDGE

edge working tools



ABRACADABRA EDGE

Resin Polishing Wheels for GRANITE



GRIT	CODE Ø130 (5")	CODE Ø150 (6")
60/80	CLRLE08A	CLRLE080
100	CLRLE10A	CLRLE100
200	CLRLE20A	CLRLE200
400	CLRLE40A	CLRLE400
600	CLRLE60A	CLRLE600
800	CLRLE80A	CLRLE800
1500	CLRLE15A	CLRLEA15
3500	CLRLE35A	CLRLEA35
5000	CLRLE50A	CLRLEA50



ABRACADABRA EDGE

Resin Polishing Wheels for ENGINEERED STONE



GRIT	CODE Ø130 (5")	CODE Ø150 (6")
60/80	CLRLE08A	CLRLE080
100	CLRLE10A	CLRLE100
200	CLRLE20A	CLRLE200
400	CLRLE40A	CLRLE400
600	CLRLE60A	CLRLE600
800	CLRLE80A	CLRLE800
1500	CLRLE15A	CLRLGA15
3500	CLRLG35A	CLRLGA35
5000	CLRLG50A	CLRLGA50



ABRACADABRA EDGE is a new diamond ceramic wheel that it is proving to be very versatile and appreciated by the customers that have used them. It can polish equally well on natural stone and engineered stone without the need to change wheel's type. **It is very aggressive, has long life and gives a good finish.**

Advised for flat and bevel:





ProGlo

by NICOLAI

Resin Diamond Edge Polishers for Granite, Engineered Stone & Marble

CAYMAN	GATOR	EAGLE	HAWK	BULL	CHAMFER
FLAT	FLAT	RADIUS	FLAT	BULLNOSE	CHAMFER
		BULLNOSE	RADIUS		
			BULLNOSE	Also recommended for edges with small radius	
Dim. 130x8 / 150x7	Dim. 130x14 / 150x12	Dim. 130x10 / 150x10	Dim. 130x14 / 150x12	Dim. 130x10	Dim. 130x10
WRENCH: 32 mm	WRENCH: 32 mm	WRENCH: 19 mm	WRENCH: 19 mm	WRENCH: 19 mm	WRENCH: 32 mm

Yes, the wheel is REINVENTED !

Technologically advanced, ProGlo wheels are scrutinized for highest quality, have thickest resin (long lasting) and advanced design. **ProGlo...** preferred for perfection !



5 Heads system	1	2	3	4	5			
	220	400	800	1800	3500			
6 Heads system	1	2	3	4	5	6		
	120	220	400	800	1800	3500		
7 Heads system	1	2	3	4	5	6	7	
	60	120	220	400	800	1800	3500	
8 Heads system	1	2	3	4	5	6	7	8
	60	120	220	400	600	800	1800	3500



Watch the video @ nicolaiprogl.com



ProGlo CAYMAN

Resin Polishing Wheels for GRANITE & ES



GRIT	Ø 130 mm 5 inches	Ø 150 mm 6 inches
60	ALRPC3GE0060	ALRPC5GE0060
120	ALRPC3GE0120	ALRPC5GE0120
220	ALRPC3GE0220	ALRPC5GE0220
300*	ALRPC3GE0300	ALRPC5GE0300
400	ALRPC3GN0400	ALRPC5GN0400
600	ALRPC3GN0600	ALRPC5GN0600
800	ALRPC3GN0800	ALRPC5GN0800
1200*	ALRPC3GN1200	ALRPC5GN1200
1800	ALRPC3GN1800	ALRPC5GN1800
2500*	ALRPC3GN2500	ALRPC5GN2500
3500	ALRPC3GN3500	ALRPC5GN3500
3500	ALRPC3GW3500 (white)	ALRPC5GW3500 (white)



* upon request

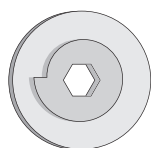

Fitting: Snail lock
Wrench: 32 mm
Wheel Sizes:
Ø 130 wheel, 8 mm thickness
Ø 150 wheel, 7 mm thickness



3500 White Wheel
Recommended to be used for light colored Engineered Stone

▲
Ø 130, 30 mm
▼
Ø 150, 29 mm

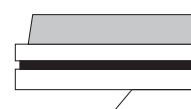

ProGlo GATOR

Resin Polishing Wheels for GRANITE & ES



GRIT	Ø 130 mm 5 inches	Ø 150 mm 6 inches
60	ALRPG3GE0060	ALRPG5GE0060
120	ALRPG3GE0120	ALRPG5GE0120
220	ALRPG3GE0220	ALRPG5GE0220
300*	ALRPG3GE0300	ALRPG5GE0300
400	ALRPG3GE0400	ALRPG5GE0400
600	ALRPG3GE0600	ALRPG5GE0600
800	ALRPG3GE0800	ALRPG5GE0800
1200*	ALRPG3GE1200	ALRPG5GE1200
1800	ALRPG3GE1800	ALRPG5GE1800
2500*	ALRPG3GE2500	ALRPG5GE2500
3500	ALRPG3GE3500	ALRPG5GE3500
3500	ALRPG3GW3500 (white)	ALRPG5GW3500 (white)



* upon request

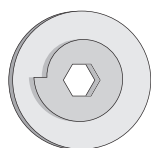

Fitting: Snail lock
Wrench: 32 mm
Wheel Sizes:
Ø 130 wheel, 14 mm thickness
Ø 150 wheel, 12 mm thickness



3500 White Wheel
Recommended to be used for light colored Engineered Stone

▲
Ø 130, 34 mm
▼
Ø 150, 36 mm

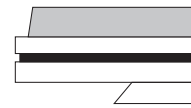



ProGlo EAGLE

Resin Polishing Wheels for GRANITE & ES - **Suggested for Single Head Machines: Flat, Bullnose and Half Bullnose**



GRIT	Ø 130 mm 5 inches	Ø 150 mm 6 inches
60	ALRPE3GE0060	ALRPE5GE0060
100	ALRPE3GE0100	ALRPE5GE0100
120	ALRPE3GE0120	ALRPE5GE0120
220	ALRPE3GE0220	ALRPE5GE0220
300*	ALRPE3GE0300	ALRPE5GE0300
400	ALRPE3GE0400	ALRPE5GE0400
600	ALRPE3GE0600	ALRPE5GE0600
800	ALRPE3GE0800	ALRPE5GE0800
1200*	ALRPE3GE1200	ALRPE5GE1200
1800	ALRPE3GE1800	ALRPE5GE1800
2500*	ALRPE3GE2500	ALRPE5GE2500
3500	ALRPE3GE3500	ALRPE5GE3500
3500	ALRPE3GW3500 (white)	ALRPE5GW3500 (white)

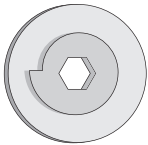

Fitting: Snail lock
Wrench: 19 mm
Wheel Sizes:
Ø 130 wheel, 10 mm thickness
Ø 150 wheel, 10 mm thickness



3500 White Wheel
Recommended to be used for light colored Engineered Stone

▲
Ø 130, 34 mm
▼
Ø 150, 34 mm

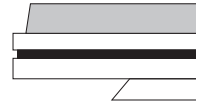

ProGlo HAWK

Resin Polishing Wheels for GRANITE & ES



GRIT	Ø 130 mm 5 inches	Ø 150 mm 6 inches
60	ALRPH3GE0060	ALRPH5GE0060
120	ALRPH3GE0120	ALRPH5GE0120
220	ALRPH3GE0220	ALRPH5GE0220
300*	ALRPH3GE0300	ALRPH5GE0300
400	ALRPH3GE0400	ALRPH5GE0400
600	ALRPH3GE0600	ALRPH5GE0600
800	ALRPH3GE0800	ALRPH5GE0800
1200*	ALRPH3GE1200	ALRPH5GE1200
1800	ALRPH3GE1800	ALRPH5GE1800
2500*	ALRPH3GE2500	ALRPH5GE2500
3500	ALRPH3GE3500	ALRPH5GE3500
3500	ALRPH3GW3500 (white)	ALRPH5GW3500 (white)

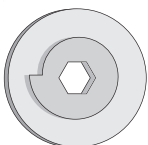

Fitting: Snail lock
Wrench: 19 mm
Wheel Sizes:
Ø 130 wheel, 14 mm thickness
Ø 150 wheel, 12 mm thickness



3500 White Wheel
Recommended to be used for light colored Engineered Stone

▲
Ø 130, 36 mm
▼
Ø 150, 34 mm

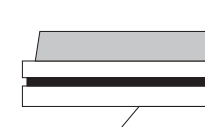



ProGlo BULL

Resin Polishing Wheels for GRANITE & ES



GRIT	Ø 130 mm 5 inches
60	ALRPB3GE0060
120	ALRPB3GE0120
220	ALRPB3GE0220
300*	ALRPB3GE0300
400	ALRPB3GE0400
600	ALRPB3GE0600
800	ALRPB3GE0800
1200*	ALRPB3GE1200
1800	ALRPB3GE1800
2500*	ALRPB3GE2500
3500	ALRPB3GE3500
3500	ALRPB3GW3500 (white)



* upon request

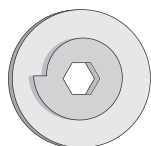

Fitting: Snail lock
Wrench: 19 mm
Wheel Sizes:
Ø 130 wheel, 10 mm thickness



3500 White Wheel
Recommended to be
used for light colored
Engineered Stone

▲
32 mm
▼

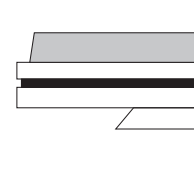

ProGlo CHAMFER (BEVELLING)

Resin Polishing Wheels for GRANITE & ES



GRIT	Ø 130 mm 5 inches
400	ALRPF3GE0400
600	ALRPF3GE0600
800	ALRPF3GE0800
1200	ALRPF3GE1200
1800	ALRPF3GE1800

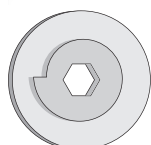
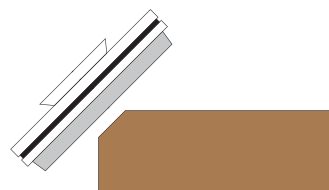

Fitting: Snail lock
Wrench: 32 mm
Wheel Sizes:
Ø 130 wheel, 10 mm thickness

▲
31 mm
▼

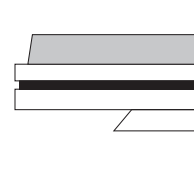





MANUAL MACHINE tooling





MARMO / GHINES WHEELS

External Cooling - Set for GRANITE

		STEP 1	STEP 2	STEP 3	STEP 4	STEP 5	STEP 6	STEP 7
	PRF	G1 SEG	G1 FCC	G2 FCC	D3 ELE*	G3 RESIN*	G4 RESIN	G5 RESIN
	V20	ASSC2510	ASFC2510	ASFC2520	ASEC2530	CSi11376i2	CSi11377i2	CSi11378i2
	V30	ASSC2610	ASFC2610	ASFC2620	ASEC2630	CSi11386i2	CSi11387i2	CSi11388i2
	V40	ASSC2710	ASFC2710	ASFC2720	ASEC2730	CSi11396i2	CSi11397i2	CSi11398i2
	F20	ASSC1510	ASFC1510	ASFC1520	ASEC1530	CSi11136i2	CSi11137i2	CSi11138i2
	F30	ASSC1610	ASFC1610	ASFC1620	ASEC1630	CSi11146i2	CSi11147i2	CSi11148i2
	F40	ASSC1710	ASFC1710	ASFC1720	ASEC1730	CSi11156i2	CSi11157i2	CSi11158i2
	B10	ASSC0010	ASFC0010	ASFC0020	ASEC0030	CSi11026i2	CSi11027i2	CSi11028i2
	B15	ASSC0110	ASFC0110	ASFC0120	ASEC0130	CSi11036i2	CSi11037i2	CSi11038i2
	B20	ASSC0210	ASFC0210	ASFC0220	ASEC0230	CSi11046i2	CSi11047i2	CSi11048i2
	H20	ASSC2010	ASFC2010	ASFC2020	ASEC2030			
	H30					CSi11196i2	CSi11197i2	CSi11198i2
	E20	ASSC1010	ASFC1010	ASFC1020	ASEC1030	CSi11106i2	CSi11107i2	CSi11108i2
	L20	ASSC3710	ASFC3710	ASFC3720		CSi11256i2	CSi11257i2	CSi11258i2
	L30	ASSC3810	ASFC3810	ASFC3820		CSi11266i2	CSi11267i2	CSi11268i2



If you use the G1 Segmented Wheel By-Pass the G1 Fcc Step
 * If you use the G3 Electroplated Wheel By-Pass the G3 Resin Step
 G3, G4, G5, G6 are without bearing
 All the wheels are without water holes

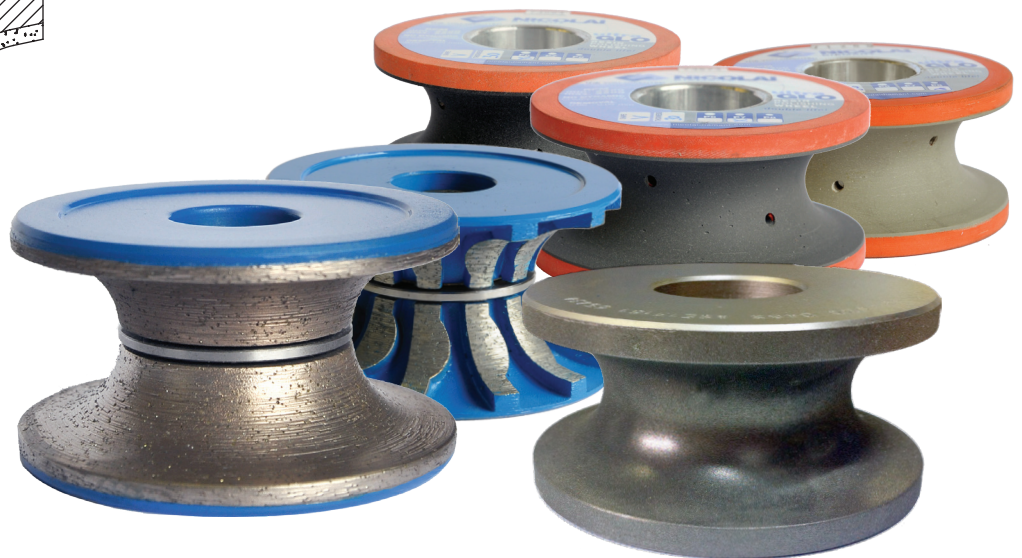
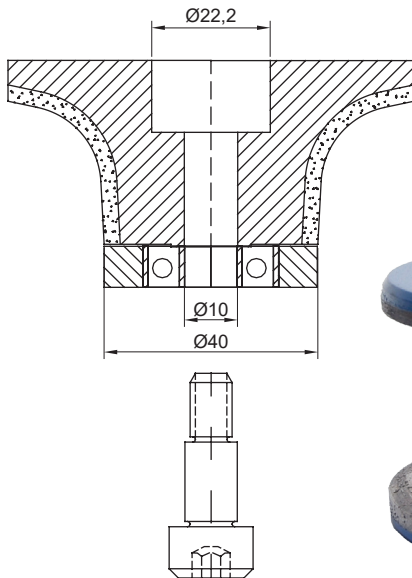

MARMO / GHINES WHEELS

manual machine tooling



MARMO / GHINES WHEELS - ELECTROPLATED

External Cooling - Set for MARBLE

	PRF	D1 ELE	D2 ELE	D3 ELE
	V20	ASEC2510	ASEC2520	ASEC2530
	V30	ASEC2610	ASEC2620	ASEC2630
	V40	ASEC2710	ASEC2720	ASEC2730
	F20	ASEC1510	ASEC1520	ASEC1530
	F30	ASEC1610	ASEC1620	ASEC1630
	F40	ASEC1710	ASEC1720	ASEC1730
	B10	ASEC0010	ASEC0020	ASEC0030
	B15	ASEC0110	ASEC0120	ASEC0130
	B20	ASEC0210	ASEC0220	ASEC0230
	H20	ASEC2010	ASEC2020	ASEC2030
	E20	ASEC1010	ASEC1020	ASEC1030

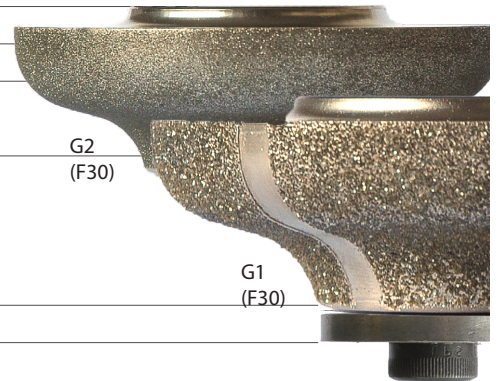

G3, G4, G5, G6 are without bearing
All the wheels are without water holes

SCREW for MARMO

A= Rectified Shank

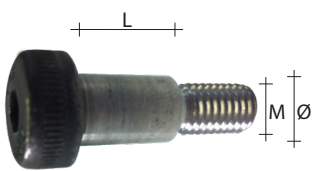

CODE	SIZE	FITTING
AZZ00062	Ø10 L6	M8
AZZ00063	Ø10 L20	M8
AZZ00064	Ø10 L25	M8
AZZ00065	Ø10 L30	M8
AZZ00066	Ø10 L35	M8
AZZ00068	Ø10 L40	M8

1/2 GAS ADAPTER

for MARMO



CODE	SIZE	FITTING
AZT0729A	Ø22.2	1/2 GAS >M8

1/2 GAS ADAPTER
AZT0729A



SCREW for GNS

A= Rectified Shank

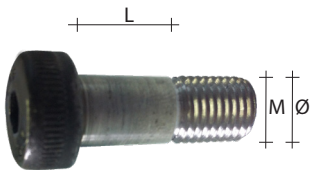

CODE	SIZE	FITTING
AZZ00269	Ø10 L16	M10
AZZ00254	Ø10 L20	M10
AZZ00255	Ø10 L25	M10
AZZ00297	Ø10 L30	M10
AZZ00327	Ø10 L35	M10
AZZ00298	Ø10 L40	M10



OMA WHEELS

Internal Cooling - Set for GRANITE & MARBLE

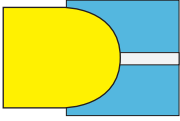
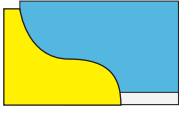
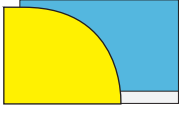
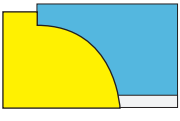
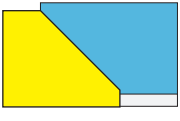
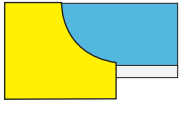
	STEP 1	STEP 2	STEP 3	STEP 4	STEP 5	STEP 6	
	PRF G1 SEG	D2 ELE	D3 ELE	G3 RESIN	G4 RESIN	G5 RESIN	
V20	ASSO2510	ASEO2510	ASEO2520	CSi1O376	CSi1O377	CSi1O378	
V30	ASSO2710	ASEO2710	ASEO2720	CSi1O386	CSi1O387	CSi1O388	
V40	ASSO2810	ASEO2810	ASEO2820	CSi1O396	CSi1O397	CSi1O398	
	F20	ASSO1510	ASEO1510	ASEO1520	CSi1O136	CSi1O137	CSi1O138
F30	ASSO1610	ASEO1610	ASEO1620	CSi1O146	CSi1O147	CSi1O148	
F40	ASSO1710	ASEO1710	ASEO1720	CSi1O156	CSi1O157	CSi1O158	
	B10	ASSO0010	ASEO0010	ASEO0020	CSi1O026	CSi1O027	CSi1O028
B15	ASSO0110	ASEO0110	ASEO0120	CSi1O036	CSi1O037	CSi1O038	
B20	ASSO0210	ASEO0210	ASEO0220	CSi1O046	CSi1O047	CSi1O048	
	H20	ASSO2010	ASEO2010	ASEO2020	CSi1O196	CSi1O197	CSi1O198
	E20	ASSO1010	ASEO1010	ASEO1020	CSi1O106	CSi1O107	CSi1O108
	L20	ASSO3710	ASEO3710	ASEO3720	CSi1O256	CSi1O257	CSi1O258
L30	ASSO3810	ASEO3810	ASEO3820	CSi1O266	CSi1O267	CSi1O268	



All the wheels are with water holes

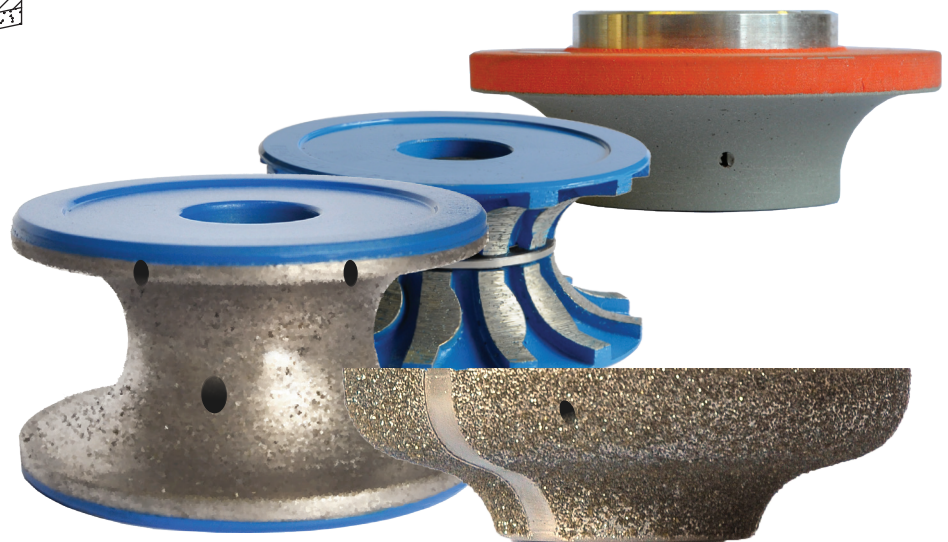
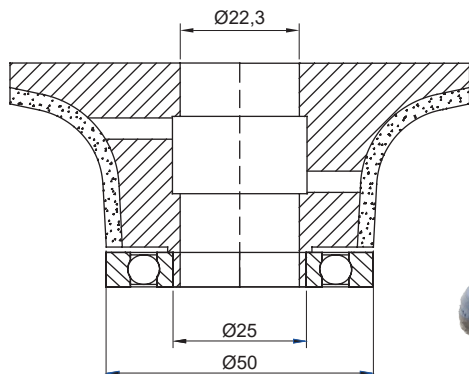

FLEX (M14 Female)

manual machine tooling



FLEX WHEELS

Internal Cooling - Set for GRANITE & MARBLE

		STEP 1	STEP 2	STEP 3
PRF	R	G1 SEG	G1 FCC	G2 FCC
B10	10	ASSZ0010	ASFZ0010	ASFZ0020
B15	15	ASSZ0110	ASFZ0110	ASFZ0120
B20	20	ASSZ0210	ASFZ0210	ASFZ0220
L20	10	ASSZ3710	ASFZ3710	ASFZ3720
L30	15	ASSZ3810	ASFZ3810	ASFZ3820

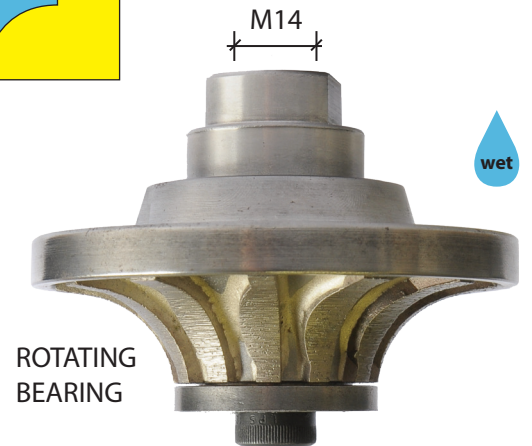
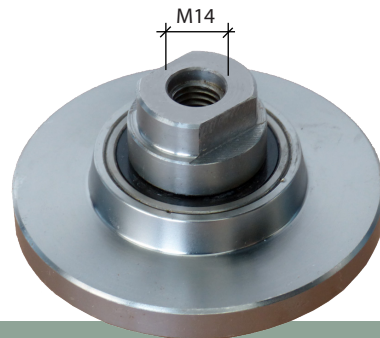
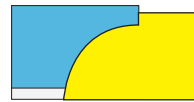
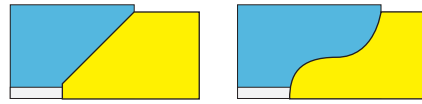
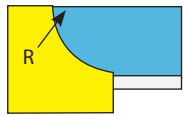
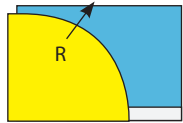

ELECTROPLATED FLEX (M14 Female)

manual machine tooling



ELECTROPLATED FLEX WHEELS

Internal Cooling - Set for MARBLE

PRF	R	D1 ELE	D2 ELE	D3 ELE
B10	10	ASEZ0010	ASEZ0020	ASEZ0030
B15	15	ASEZ0110	ASEZ0120	ASEZ0130
B20	20	ASEZ0210	ASEZ0220	ASEZ0230
L20	10	ASEZ3710	ASEZ3720	ASEZ3730
L30	15	ASEZ3810	ASEZ3820	ASEZ3830

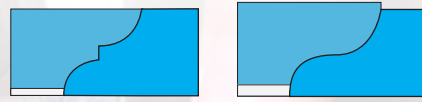
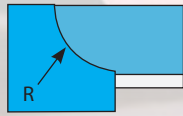
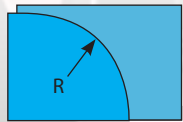

All the wheels are without water holes

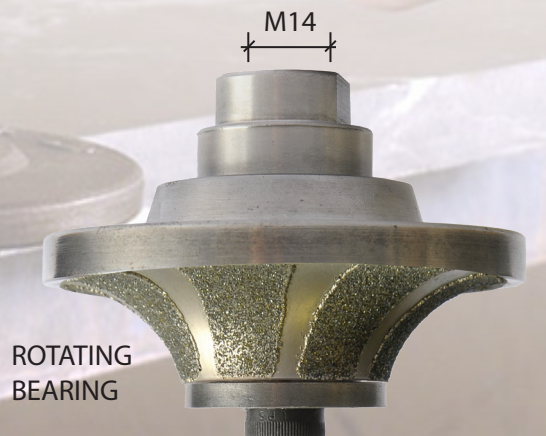



I DIA - Polishing Pads for Dry Use

D100 mm (4") w/ Velcro back

CODE	
CCR65KIT	Kit 6 discs
grits:	
60 / 120 / 200 / 400 / 800	
1500 / 3000	

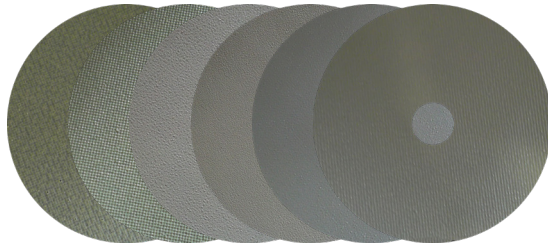

DRY FLASH 5 - Polishing Pads for Dry Use

D100 mm (4") w/ Velcro back

CODE	GRIT
CCR40061	#1
CCR40062	#2
CCR40063	#3
CCR40064	#4
CCR40065	#5

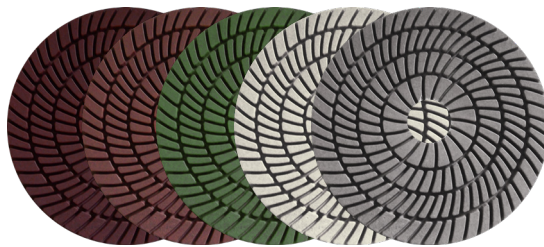

Adaptor for Pads

D100 mm (4") Fitt. M14 - w/ Velcro back

CODE	GRIT
AZT1508A	Soft
AZZ00197	Medium
AZZ00227	Hard



WET POLISHING DISCS

manual machine tooling



DIAHARD - Polishing Pads for Wet Use
D100 mm (4") w/Velcro back

CODE	GRIT
CCR63005	#1
CCR63010	#2
CCR63015	#3
CCR63020	#4
CCR63025	#5
CCR63030	#6

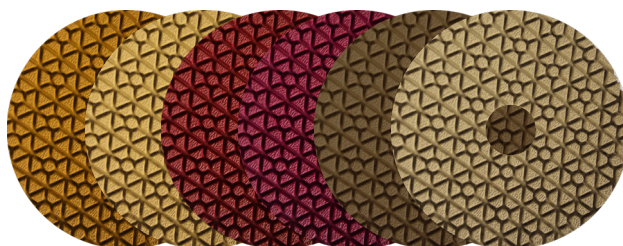

Adaptor for Pads
D100 mm (4") Fitt. M14 - w/Velcro back

CODE	GRIT
AZT1508A	Soft
AZZ00197	Medium
AZZ00227	Hard



CUP & SLOT WHEELS



CUP WHEELS w/M14



CODE	SIZE	CORE	FITTING	GRIT
DSS0443S	Ø 70	35	M14	Segmented G1
DSS04431	Ø 70	35	M14	Segmented G2
on request	Ø 70	45	M14	Segmented G1
DSS0444S	Ø 70	50	M14	Segmented G1
DSS2940S	Ø 75	50	M14	Segmented G1
DSS3829S	Ø 70	70	M14	Segmented G1
DSE4839D	Ø 70	35	M14	Electroplated G2
DSE4838D	Ø 70	50	M14	Electroplated G2



TURBO CUP WHEELS Various fittings



CODE	SIZE	FITTING	GRIT
ACFC144S	Ø100 x 20 x 4,5 mm	M14	TZ1T
ACFC144U	Ø100 x 20 x 4,5 mm	M14	TZ2
ACFC144V	Ø100 x 20 x 4,5 mm	M14	TZ3
ACFC224S	Ø100 x 20 x 4,5 mm	F 22.2	TZ1T
ACFC224U	Ø100 x 20 x 4,5 mm	F 22.2	TZ2
ACFC224V	Ø100 x 20 x 4,5 mm	F 22.2	TZ3
CCTU1002 ☺	Ø100 x 20 x 4,5 mm	M14	HLA



SLOTING WHEELS Segmented w/M14

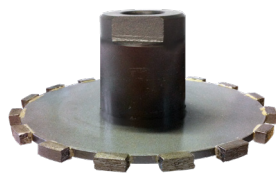

CODE	SIZE	CORE	FITTING	TYPE
DSS1454S	Ø100 x 6 mm		M14	Segmented
DSS2074S	Ø80 x 6 mm		M14	Segmented
DSS2075S	Ø70 x 6 mm		M14	Segmented
DSS3209S	Ø100 x 8 mm		M14	Segmented
DSS3679S	Ø100 x 5 mm		M14	Segmented
DSS4314S	Ø35 x 10 mm		M14	Segmented
DSS4315S	Ø30 x 10 mm		M14	Segmented
DSS4789S	Ø75 x 6 mm		M14	Segmented
DSS4816S	Ø65 x 6 mm		M14	Segmented
DSS54413	Ø60 x 10 mm		M14	Segmented
DSS5441S	Ø60 x 10 mm		M14	Segmented
DSE3679C	Ø100 x 5 mm		M14	Electroplated
DSE4009D	Ø60 x 8 mm		M14	Electroplated
DSE4099D	Ø100 x 8 mm		M14	Electroplated
DSE4741C	Ø120 x 5 mm		M14	Electroplated
EME00019	Ø125 x 8 mm		M14	Electroplated



CORE DRILLS



CORE DRILLS

Electroplated w/ M14 FEMALE



CODE	SIZE	FITTING
APE50020	Ø20 (25/32") x 50 mm	M14 fem
APE50025	Ø25 (1") x 50 mm	M14 fem
APE50030	Ø30 (1-3/16") x 50 mm	M14 fem
APE50032	Ø32 (1-17/64") x 50 mm	M14 fem
APE50035	Ø35 (1-3/8") x 50 mm	M14 fem
APE50040	Ø40 (1-37/64") x 50 mm	M14 fem
APE50050	Ø50 (2") x 50 mm	M14 fem
APE50060	Ø60 (2-3/8") x 50 mm	M14 fem



ADAPTERS

For M14 Core Bits



CODE	FITTING	FITTING
AZT0597A *	D12 x 30	M14
AZT0596A **	D12 x 30	M14 + F6.2 x 30 + M6
AZT0568A ***	1/2 GAS	M14

SEG CORE DRILLS

Segmented w/ WIDIA MILL



CODE	SIZE	FITTING	RPM	FEED
APS6E020	Ø20 (25/32") x 60 mm	Cylindrical		
APS6E025	Ø25 (1") x 60 mm	Cylindrical		
APS6E030	Ø30 (1-3/16") x 60 mm	Cylindrical	2800-3500	
APS6E032	Ø32 (1-17/64") x 60 mm	Cylindrical		
APS6E035	Ø35 (1-3/8") x 60 mm	Cylindrical		60-120
APS6E040	Ø40 (1-37/64") x 60 mm	Cylindrical		
APS6E050	Ø50 (2") x 60 mm	Cylindrical	2300-2800	
APS6E060	Ø60 (2-3/8") x 60 mm	Cylindrical		
APS6E070	Ø70 (2-3/4") x 60 mm	Cylindrical		
APS6E080	Ø80 (3-5/32") x 60 mm	Cylindrical		
APS6E090	Ø90 (3-35/64") x 60 mm	Cylindrical	1000-1500	50-100
APS6E100	Ø100 (4") x 60 mm	Cylindrical		
APS6E130	Ø130 (5-7/64") x 60 mm	Cylindrical		





DRILL BITS A= 1/2 Gas

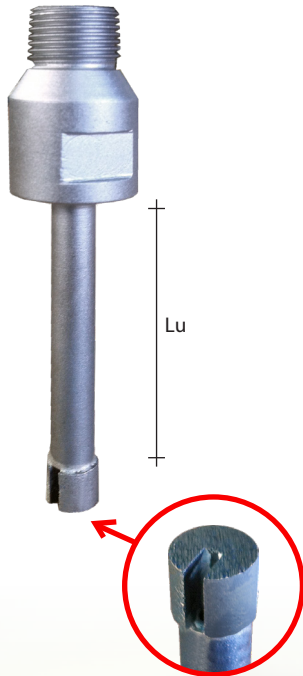

CODE	SIZE	Lu	FITTING	THREAD
ATS0203A *	Ø4	22	1/2 Gas	Right
ATS0403A *	Ø5	42	1/2 Gas	Right
ATS0503B	Ø6	50	1/2 Gas	Right
ATS0603B	Ø6.5	50	1/2 Gas	Right
ATS0703B	Ø7	50	1/2 Gas	Right
ATS0803C	Ø8	50	1/2 Gas	Right
ATS0903C	Ø9	50	1/2 Gas	Right
ATS1003C	Ø10	50	1/2 Gas	Right
ATS1103C	Ø11	50	1/2 Gas	Right
ATS1203C	Ø12	50	1/2 Gas	Right
ATS1303C	Ø13	50	1/2 Gas	Right
ATS1403C	Ø14	50	1/2 Gas	Right
ATS1503C	Ø15	50	1/2 Gas	Right

* made in two separate pieces



DRILL BITS A= M12-M14



CODE M12	CODE M14	SIZE	THREAD
ATS0201A	ATS0202A	Ø4 L22	Right
ATS0401A	ATS0402A	Ø5 L22	Right
ATS0501B	ATS0502B	Ø6 L50	Right
ATS0601B	ATS0602B	Ø6.5 L50	Right
ATS0701B	ATS0702B	Ø7 L50	Right
ATS0801C	ATS0802C	Ø8 L50	Right
ATS0901C	ATS0902C	Ø9 L50	Right
ATS1001C	ATS1002C	Ø10 L50	Right
ATS1101C	ATS1102C	Ø11 L50	Right
ATS1201C	ATS1202C	Ø12 L50	Right
ATS1301C	ATS1302C	Ø13 L50	Right
ATS1401C	ATS1402C	Ø14 L50	Right
ATS1501C	ATS1502C	Ø15 L50	Right



ANCHORING SYSTEM

manual machine tooling



T31
External Cooling

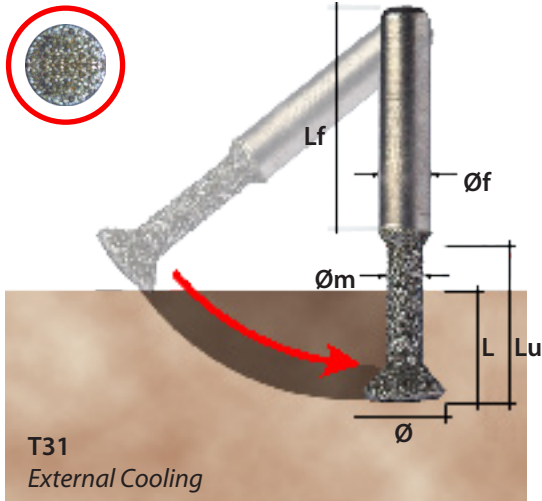

T31
External Cooling



GND
Internal Cooling

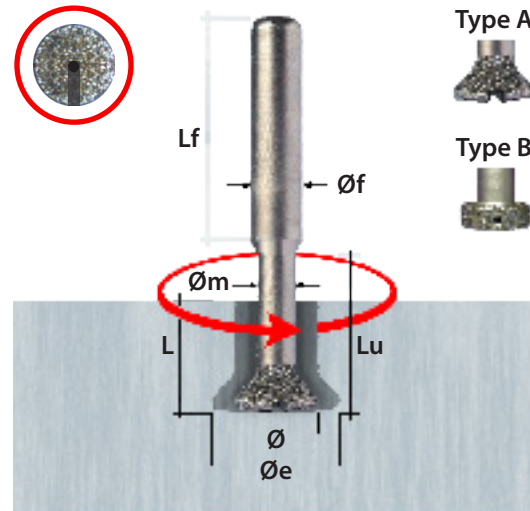

Type A

Type B

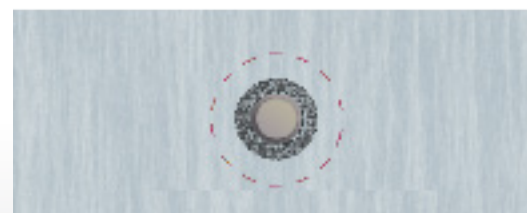

GR

ES

MR



Measures and fittings are available on request.
Send us your drawing and we are glad to help you!

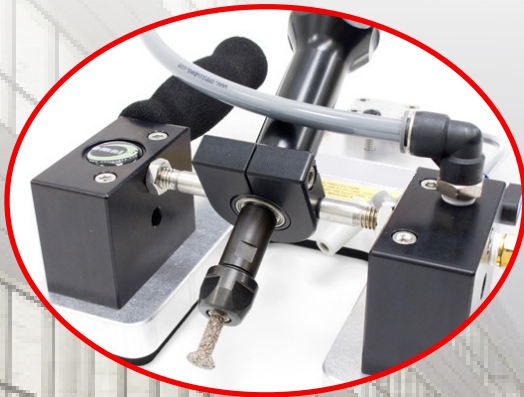

1/4" Ø STAINLESS STEEL
BOLT, NUT, FLAT WASHER
AND LOCK WASHER

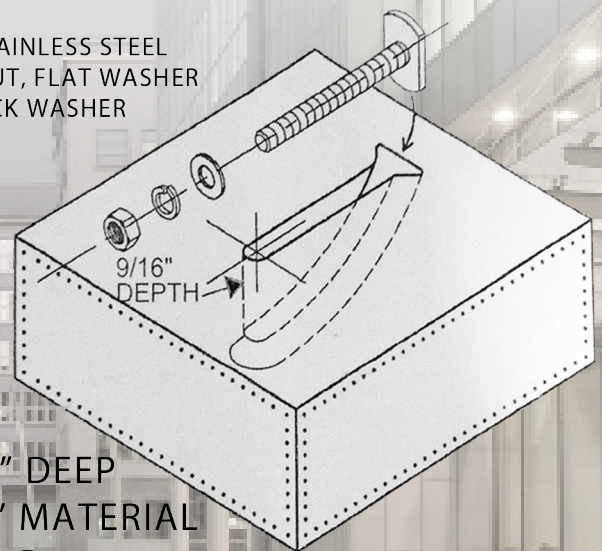

1-1/2" DEEP
ON 3" MATERIAL
D016, D017

TYPE #31



F22 TURBO BLADES

w/f22.2



CODE	SIZE	CORE	TYPE
CDTU1150	Ø115 mm	f 22.2	Segmented
CDTU1250	Ø125 mm	f 22.2	Segmented
CDTU1501	Ø150 mm	f 22.2	Segmented
CDTU1800	Ø180 mm	f 22.2	Segmented
CDTU2300	Ø230 mm	f 22.2	Segmented



M14 TURBO BLADES

w/M14



CODE	SIZE	CORE	TYPE
CDTU1154	Ø115 mm	M14	Segmented
CDTU1254	Ø125 mm	M14	Segmented
CDTU1502	Ø150 mm	M14	Segmented



FCD TURBO BLADES

w/ FLANGE

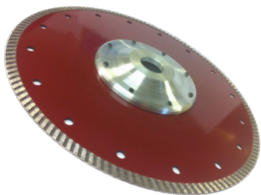

CODE	SIZE	CORE	TYPE
CDTU1801	Ø180 mm	Flange CD	Segmented
CDTU2301	Ø230 mm	Flange CD	Segmented

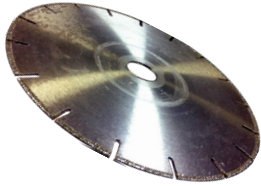

ELECTROPLATED BLADES*manual machine tooling***F22 ELECTROPLATED BLADES***w/f22.2*

CODE	SIZE	CORE	TYPE
CDE31151	Ø115 mm	2 mm	f 22.2
CDE31251	Ø125 mm	2 mm	f 22.2
CDE31501	Ø150 mm	2 mm	f 22.2
CDE31801	Ø180 mm	2.8 mm	f 22.2
CDE32302	Ø230 mm	2.8 mm	f 22.2

**M14 ELECTROPLATED BLADES***w/M14*

CODE	SIZE	CORE	TYPE
CDE31153	Ø115 mm	2 mm	M14
CDE31253	Ø125 mm	2 mm	M14
CDE31503	Ø150 mm	2 mm	M14

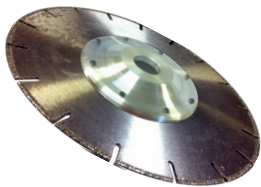
**FCD ELECTROPLATED BLADES***w/ FLANGE*

CODE	SIZE	CORE	TYPE
CDE31804	Ø180 mm	2.8 mm	CD 22.2
CDE12304	Ø230 mm	2.8 mm	CD 22.2

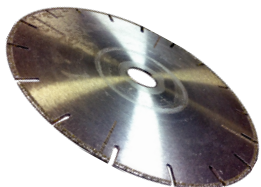
**REINFORCED ELECTROPLATED BLADES***w/ Reinforces*

CODE	SIZE	CORE	TYPE	REINFORCES
on request	Ø115 mm	2 mm	f 22.2	4+4 6x13
on request	Ø125 mm	2 mm	f 22.2	4+4 6x13
on request	Ø150 mm	2 mm	f 22.2	4+4 6x13
CDE32304	Ø230 mm	2.8 mm	CD 22.2	4+4 6x30
on request	Ø230 mm	2.8 mm	CD 22.2	4+8 6x60

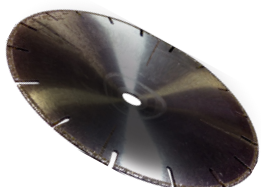
**CONCAVE ELECTROPLATED BLADES***Concave w/ Reinforces*

CODE	SIZE	CORE	TYPE	REINFORCES
CDE41250	Ø125 mm	2 mm	f 22.2	4+4 6x30
CDE41800	Ø180 mm	2.8 mm	f 22.2	4+4 6x40
CDE42300	Ø230 mm	2.8 mm	f 22.2	4+4 6x60





BLADES for wet cutting

PERIPHERAL SPEED OF BLADES

MATERIAL	25	30	35	40	45	50	55	60
GRANITE	Orange	Orange	Orange	Grey	Grey	Grey	Grey	Grey
MARBLE	Grey	Grey	Grey	Orange	Orange	Orange	Grey	Grey
SANDSTONE	Grey	Orange	Orange	Orange	Orange	Orange	Grey	Grey
SLATE	Grey	Grey	Orange	Orange	Orange	Orange	Grey	Grey
TRAVERTINE	Grey	Grey	Grey	Grey	Orange	Orange	Orange	Orange

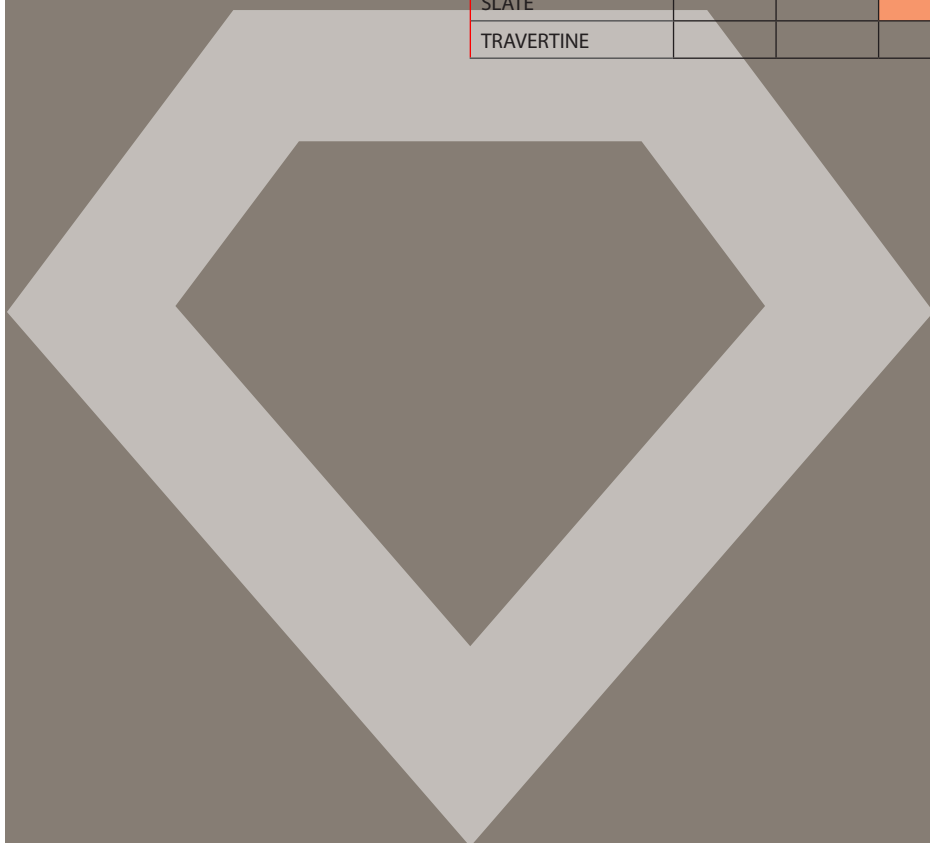



GREEN ZEBRA MULTILAYER FAST CUTTING FOR GRANITE

Zebra series

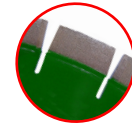

CODE SILENT	Ø	H	Z	CORE	BORE	RPM (30-35m/s)	Feed (mm/min)
CDS35B00S	350 - 14"	15	25	SDW	50/60	1900-2200	
CDS40A00S	400 - 16"	15	28	SDW	50/60		
CDS40A01S	400 - 16"	15	28	SDW	90	1400-1600	
CDS40A03S	400 - 16"	15	28	SDW	90+2B		
CDS45B00S	450 - 18"	15	32	SDW	50/60		1500-5000mm
CDS45B01S	450 - 18"	15	32	SDW	90+2B	1270-1450	
CDS45B02S	450 - 18"	15	32	SDW	120		
CDS50B00S	500 - 20"	15	34	SDW	50/60	1100-1350	
CDS50B01S	500 - 20"	15	34	SDW	50/60		



TAURUS BLADES BIG DIAMETER

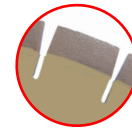

CODE SILENT	Ø	H	Z	CORE	BORE	RPM (30-35m/s)	Feed (mm/min)
D500NI8601536P	500 - 20"	15	60	NOR	50/60	1100-1350	
D500SI8601536P	500 - 20"	15	60	SDW	50/60		
D625SI8721545P	625 - 25"	15	72	SDW	50/60	950-1200	1500-5000mm
D725SI8801055U	725 - 20"	10	80	SDW	80	820-1000	
D800LI8921055U	800 - 32"	10	92	LAS	90/100	700-950	
D825LI8921055U	825 - 33"	10	92	LAS	90/100	700-900	



HMB28 BIGGER STEEL & WIDER SEGMENTS

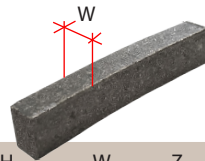

REINFORCED

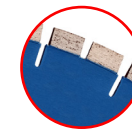

CODE SILENT	Ø	H	W	Z	CORE	BORE	RPM (30-35m/s)	Feed (mm/min)
D250LMV301040O	250 - 10"	10	4	30	LAS/3	50	2200-2600	
D300LMV361040O	300 - 12"	10	4	36	LAS/3	60	1900-2200	
D350LMV421044O	350 - 14"	10	4.4	42	LAS/3	50	1600-1900	1500-5000mm
D400LMV481044P	400 - 16"	10	4.4	48	LAS/3.5	60	1400-1600	
D500LMV601050P	500 - 20"	10	5	60	LAS/3.5	60	1100-1350	



NOTE: Feed rates depend on the slab thickness, material type, blade type, machine type, motor size and cooling water. It is recommended to reduce the feed rate by 50% or more during the insertion and exit cuts of the slab cutting process.

NOR: normal steel core
SDW: sandwich steel core (silenced)
LAS: laser steel core (silenced)

BLADES FOR MARBLE

blades



MR70 BLADES
 SILENT & NORMAL CORE

CODE	Ø	H	W	Z	CORE	BORE	RPM (40-45m/s)	Feed (mm/min)
D300SF02107300	300 - 12"	7	3	21	SDW	50	2550-3000	1500-2800mm
D300N2P2507300	300 - 12"	7	3	25	NOR	50		
D350SF02507300	350 - 14"	7	3	25	SDW	50	2200-2600	
D350NF02507300	350 - 14"	7	3	25	NOR	50		
D350SF0250730P	350 - 14"	7	3	25	SDW	60	1700-2100	
D350NF0250730P	350 - 14"	7	3	25	NOR	60		
D400NF0280734P	400 - 16"	7	3,4	28	NOR	60	1600-2000	
D400SF0280734P	400 - 16"	7	3,4	28	SDW	60		
D450NF1320740P	450 - 18"	7	4	32	NOR	60	1500-1900	
D450SF1320740P	450 - 18"	7	4	32	SDW	60		
D500NF1360740P	500 - 20"	7	4	36	NOR	60	1450-1800	
D500SF1360740P	500 - 20"	7	4	36	SDW	60		
D550NF2400750P	550 - 22"	7	5	40	NOR	60	1300-1600	
D550SF2400750P	550 - 22"	7	5	40	SDW	60		
D625NF2420750P	625 - 25"	7	5	42	NOR	60		
D625SF2420750P	625 - 25"	7	5	42	SDW	60		

MR70: soft bond (harder bonds available upon request)

MR70 BLADES SILENT CORE - WIDER SEGMENT **REINFORCED**

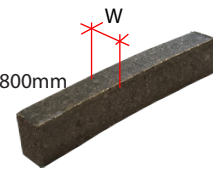
CODE	Ø	H	W	Z	CORE	BORE	RPM (40-45m/s)	Feed (mm/min)
D250LF03007400	250 - 10"	7	4	30	LAS/3	50	3000-3400	1500-2800mm
D300LF0360740P	300 - 12"	7	4	36	LAS/3	60	2550-3000	
D350LF04207450	350 - 14"	7	4,5	42	LAS/3,5	50	2200-2600	
D400LF0480750P	400 - 16"	7	5	48	LAS/3,5	60	1700-2100	
D500LF1600755P	500 - 20"	7	5,5	60	LAS/3,5	60	1500-1900	

MR70-SW BLADES SILENT & NORMAL CORE - SANDWICH SEGMENT

CODE	Ø	H	W	Z	CORE	BORE	RPM (40-45m/s)	Feed (mm/min)
D625SF9420750P	625 - 25"	7	5	42	SDW	60	1300-1600	1500-2800mm
D625NF9420750P	625 - 25"	7	5	42	NOR	60		
D650SF9380755P	650 - 26"	7	5,5	38	SDW	60	1250-1550	
D650NF9380760P	650 - 26"	7	6	38	NOR	60		
D725NF9500755P	725 - 29"	7	5,5	50	NOR	60	1200-1450	
D725SF9500755P	725 - 29"	7	5,5	50	SDW	60		
D800LF9460760T	800 - 32"	7	6	57	LAS	80		
D825NF9570760P	825 - 33"	7	6	57	NOR	60/80		
D825SF9570760P	825 - 33"	7	6	57	SDW	60/80		

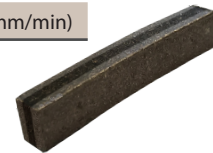

MR70-SW: sandwich soft bond (harder bonds available upon request)

NOR: normal steel core
SDW: sandwich steel core (silenced)
LAS: laser steel core (silenced)



DEKTON BLADES SILENT, LASER AND NORMAL CORE

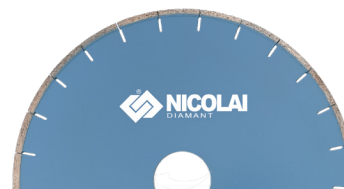

CODE	Ø mm	Z	CORE	BORE*	BOND	RPM	FEED
D300Si1210830P	Ø300 - 12"	21	SDW	B60	DEK67 G		
D300Ni1210830P ☺	Ø300 - 12"	21	NOR	B60	DEK67 G	2000-2200	
D300Li1210830P	Ø300 - 12"	21	LAS	B60	DEK67 G		
D350Si1250830P	Ø350 - 14"	25	SDW	B60	DEK67 G		
D350Ni1250830P ☺	Ø350 - 14"	25	NOR	B60	DEK67 G	1800-1900	
D350Li1250830P	Ø350 - 14"	25	LAS	B60	DEK67 G		
D350Si1250830G	Ø350 - 14"	25	SDW	B90+2	DEK67 G		
D400Si1280832P	Ø400 - 16"	28	SDW	B60	DEK67 G		
D400Ni1280832P ☺	Ø400 - 16"	28	NOR	B60	DEK67 G	1500-1700	300-400 mm/min.
D400Li1280832P	Ø400 - 16"	28	LAS	B60	DEK67 G		
D400Si1280832G	Ø400 - 16"	28	SDW	B90+2	DEK67 G		
D450Si1320834P	Ø450 - 18"	32	SDW	B60	DEK67 G		
D450Ni1320834P ☺	Ø450 - 18"	32	NOR	B60	DEK67 G	1400-1500	
D450Li1320834P	Ø450 - 18"	32	LAS	B60	DEK67 G		
D450Si1320834G	Ø450 - 18"	32	SDW	B90+2	DEK67 G		
D500Si1360834P	Ø500 - 20"	36	SDW	B60	DEK67 G		
D500Ni1360834P ☺	Ø500 - 20"	36	NOR	B60	DEK67 G	1250-1300	
D500Li1360834P	Ø500 - 20"	36	LAS	B60	DEK67 G		
D500Si1360834G	Ø500 - 20"	36	SDW	B90+2	DEK67 G		

* Also available with Bore=50mm - Others Bores available upon request

☺ = ADVISED





FLAT & PROFILING tools

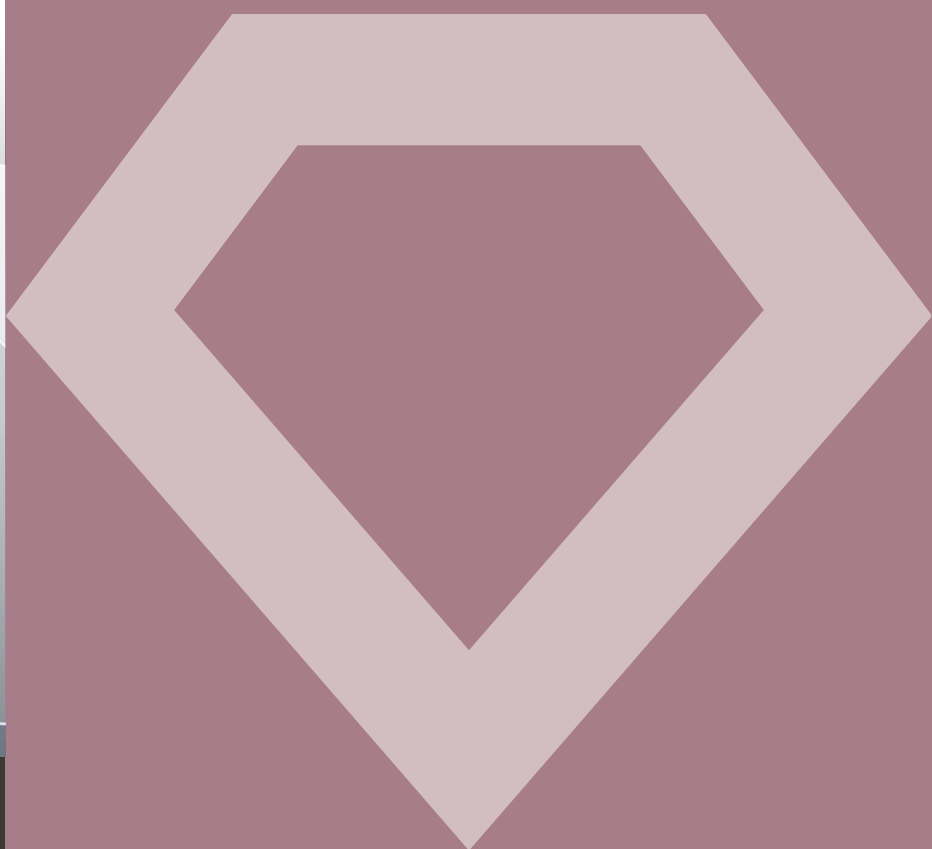



GROOVING WHEELS

Segmented



CODE	SIZE	No of SEGMENTS	SEGMENT SIZE	BORE
AMS14005	Ø 250 (10") x 6 x 7 mm	22	24 x 6 x 7 mm	50
AMS14010	Ø 250 (10") x 8 x 7 mm	22	24 x 8 x 7 mm	50
AMS14015	Ø 250 (10") x 10 x 7 mm	22	24 x 10 x 7 mm	50
AMS14020	Ø 250 (10") x 12 x 7 mm	22	24 x 12 x 7 mm	50
AMS14105	Ø 300 (12") x 6 x 7 mm	24	24 x 6 x 7 mm	50
AMS14110	Ø 300 (12") x 8 x 7 mm	24	24 x 8 x 7 mm	50
AMS14115	Ø 300 (12") x 10 x 7 mm	24	24 x 10 x 7 mm	50
AMS14120	Ø 300 (12") x 12 x 7 mm	24	24 x 12 x 7 mm	50
AMS14205	Ø 350 (14") x 6 x 7 mm	28	24 x 6 x 7 mm	50
AMS14210	Ø 350 (14") x 8 x 7 mm	28	24 x 8 x 7 mm	50
AMS14215	Ø 350 (14") x 10 x 7 mm	28	24 x 10 x 7 mm	50
AMS14220	Ø 350 (14") x 12 x 7 mm	28	24 x 12 x 7 mm	50
AMS14305	Ø 400 (16") x 6 x 7 mm	34	24 x 6 x 7 mm	50
AMS14310	Ø 400 (16") x 8 x 7 mm	34	24 x 8 x 7 mm	50
AMS14315	Ø 400 (16") x 10 x 7 mm	34	24 x 10 x 7 mm	50
AMS14320	Ø 400 (16") x 12 x 7 mm	34	24 x 12 x 7 mm	50



CODE	SIZE	No of SEGMENTS	SEGMENT SIZE	BORE
AMS14006	Ø 250 (10") x 6 x 7 mm	24	24 x 6 x 8 mm	50
AMS14011	Ø 250 (10") x 8 x 7 mm	24	24 x 8 x 8 mm	50
AMS14017	Ø 250 (10") x 10 x 7 mm	24	24 x 10 x 8 mm	50
AMS14021	Ø 250 (10") x 12 x 7 mm	24	24 x 12 x 8 mm	50
AMS14106	Ø 300 (12") x 6 x 7 mm	26	24 x 6 x 8 mm	50
AMS14111	Ø 300 (12") x 8 x 7 mm	26	24 x 8 x 8 mm	50
AMS14117	Ø 300 (12") x 10 x 7 mm	26	24 x 10 x 8 mm	50
AMS14121	Ø 300 (12") x 12 x 7 mm	26	24 x 12 x 8 mm	50
AMS14206	Ø 350 (14") x 6 x 7 mm	30	24 x 6 x 8 mm	50
AMS14211	Ø 350 (14") x 8 x 7 mm	30	24 x 8 x 8 mm	50
AMS14217	Ø 350 (14") x 10 x 7 mm	30	24 x 10 x 8 mm	50
AMS14221	Ø 350 (14") x 12 x 7 mm	30	24 x 12 x 8 mm	50
AMS14306	Ø 400 (16") x 6 x 7 mm	36	24 x 6 x 8 mm	50
AMS14311	Ø 400 (16") x 8 x 7 mm	36	24 x 8 x 8 mm	50
AMS14317	Ø 400 (16") x 10 x 7 mm	36	24 x 10 x 8 mm	50
AMS14321	Ø 400 (16") x 12 x 7 mm	36	24 x 12 x 8 mm	50



GROOVING WHEELS

flat and profiling tools



GROOVING WHEELS

Segmented for GRANITE



Type A*



Type B**

CODE Type A*	CODE Type B**	SIZE	No of SEG.	SEGMENT SIZE	BORE
AMS10446	AMSN0446	Ø 300 (12") x 15 mm	48	20 x 6 x 6 mm	60/50
AMS10451	AMSN0451	Ø 300 (12") x 20 mm	48	25 x 6 x 6 mm	60/50
AMS10456	AMSN0456	Ø 300 (12") x 25 mm	48	30 x 6 x 6 mm	60/50
AMS10461	AMSN0461	Ø 300 (12") x 30 mm	46	40 x 6 x 6 mm	60/50
AMS10471	AMSN0472	Ø 300 (12") x 40 mm	46	50 x 6 x 6 mm	60/50
AMS10646	AMSN0646	Ø 350 (14") x 15 mm	56	20 x 6 x 6 mm	60/50
AMS10651	AMSN0651	Ø 350 (14") x 20 mm	56	25 x 6 x 6 mm	60/50
AMS10656	AMSN0656	Ø 350 (14") x 25 mm	56	30 x 6 x 6 mm	60/50
AMS10661	AMSN0668	Ø 350 (14") x 30 mm	52	40 x 6 x 6 mm	60/50
AMS10671	AMSN0671	Ø 350 (14") x 40 mm	52	50 x 6 x 6 mm	60/50
AMS10846	AMSN0848	Ø 400 (16") x 15 mm	64	20 x 6 x 6 mm	60/50
AMS10851	AMSN0851	Ø 400 (16") x 20 mm	64	25 x 6 x 6 mm	60/50
AMS10856	AMSN0657	Ø 400 (16") x 25 mm	64	30 x 6 x 6 mm	60/50
AMS10861	AMSN0864	Ø 400 (16") x 30 mm	60	40 x 6 x 6 mm	60/50
AMS10871	AMSN0871	Ø 400 (16") x 40 mm	60	50 x 6 x 6 mm	60/50



GROOVING WHEELS

Segmented for MARBLE (Inclined Segments)



Type A*

CODE Type A*	SIZE	No of SEG.	SEGMENT SIZE	BORE
AMS10448	Ø 300 (12") x 15	52	20 x 6 x 6 mm	60/50
AMS10452	Ø 300 (12") x 20	52	25 x 6 x 6 mm	60/50
AMS10458	Ø 300 (12") x 25	52	30 x 6 x 6 mm	60/50
AMS10462	Ø 300 (12") x 30	52	40 x 6 x 6 mm	60/50
AMS10472	Ø 300 (12") x 40	52	50 x 6 x 6 mm	60/50
AMS10648	Ø 350 (14") x 15	56	20 x 6 x 6 mm	60/50
AMS10652	Ø 350 (14") x 20	64	25 x 6 x 6 mm	60/50
AMS10755	Ø 350 (14") x 25	64	30 x 6 x 6 mm	60/50
AMS10760	Ø 350 (14") x 30	56	40 x 6 x 6 mm	60/50
AMS10667	Ø 350 (14") x 40	56	50 x 6 x 6 mm	60/50
AMS10848	Ø 400 (16") x 15	68	20 x 6 x 6 mm	60/50
AMS10858	Ø 400 (16") x 20	68	25 x 6 x 6 mm	60/50
AMS10868	Ø 400 (16") x 25	64	30 x 6 x 6 mm	60/50
AMS10863	Ø 400 (16") x 30	64	40 x 6 x 6 mm	60/50
AMS10872	Ø 400 (16") x 40	64	50 x 6 x 6 mm	60/50





WHEELS FOR LATHE MACHINE

Segmented



CODE	SIZE	SEGMENTS	BORE	NOTE
EMS00121	Ø300 (12") x 10 mm Z36	20x10x10	50	A=2NOR/3 MR70
EMS00176	Ø350 (14") x 10 mm Z42	20x10x10	60	A=2NOR/3 MR70
ESS00009	Ø400 (16") x 10 mm Z48	20x10x10	50	A=2NOR/3,5 MR70
EMS00119	Ø500 (20") x 10 mm Z60	20x10x10	60	A=2NOR/3,5 MR70
EMS00126	Ø625 (25") x 10 mm Z72	20x10x10	60	A=2NOR/3,5 MR70



WHEELS FOR LATHE MACHINE

Segmented

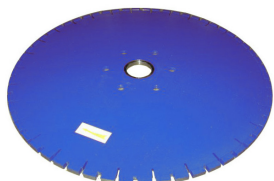

CODE	SIZE	SEGMENTS	BORE	NOTE
EMS00123	Ø300 (12") x 10 mm Z36	20x10x10	50	A=2NOR/3 NI1S
EMS00037	Ø350 (14") x 10 mm Z42	20x10x10	50	A=2NOR/3 NI1S
EMS00125	Ø400 (16") x 10 mm Z48	20x10x10	50	A=2NOR/3,5 NI1S
EMS00108	Ø500 (20") x 10 mm Z60	20x10x10	60	A=2NOR/3,5 NI1S
EMS00112	Ø625 (25") x 10 mm Z72	20x10x10	60	A=2NOR/3,5 NI1S



WHEELS FOR LATHE MACHINE

Electroplated



CODE	SIZE	SEGMENT S	BORE	NOTE
EME00060	Ø350 (14") x 10 mm	10+10+10	60	GRIT D602
EME00042	Ø400 (16") x 10 mm	10+10+10	50	GRIT D602
EME00048	Ø500 (20") x 10 mm	10+10+10	60	GRIT D602
EME00056	Ø600 (24") x 12 mm	12+15+15	50	GRIT D602



WHEELS FOR LATHE MACHINE

Electroplated w/ Reinforces



CODE	SIZE	SEGMENT S	BORE	NOTE
EME00061	Ø350 (14") x 10 mm	10+10+10	60	REINF 6x2 L60x10
EME00058	Ø400 (16") x 10 mm	10+10+10	50	REINF 8x2 L80x10
EME00045	Ø500 (20") x 10 mm	10+10+10	50	REINF 8x2 L100x10
EME00057	Ø600 (24") x 12 mm	12+15+15	50	REINF 8x2 L100x10



KIT POLISHING COLUMNS

flat and profiling tools



TURBO CUP WHEELS

w/ M14



CODE	SIZE	FITTING	GRIT
ACFC144S	Ø100 (4") x 20 x 4,5 mm	M14	TZ1T
ACFC144U	Ø100 (4") x 20 x 4,5 mm	M14	TZ2
CCTU1002 ☺	Ø100 (4") x 20 x 4,5 mm	M14	HLA



ADAPTER FOR PADS

For Profiling



CODE	SIZE	FITTING
AZT3970A	Ø100 (4")	Flange > M14
AZZ00197	Ø100 (4")	Velcro > M14

DIAHARD - Polishing Disc for WET USE

D100 w/ Velcro Back

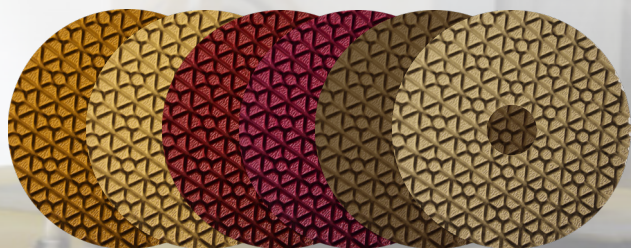

CODE	SIZE	GRIT
CCR63005	Ø100 (4")	#1
CCR63010	Ø100 (4")	#2
CCR63015	Ø100 (4")	#3
CCR63020	Ø100 (4")	#4
CCR63025	Ø100 (4")	#5
CCR63030	Ø100 (4")	#6





SEGMENTED PROFILING WHEELS

Bullnose



CODE	SIZE mm	RADIUS	SLAB	SEG SIZE	BORE
ASS75210	Ø200 (8")	10 mm	20 mm	28 mm	50 mm
ASS75215	Ø200 (8")	15 mm	30 mm	28 mm	50 mm
ASS75220	Ø200 (8")	20 mm	40 mm	28 mm	50 mm
ASS75225	Ø200 (8")	25 mm	50 mm	28 mm	50 mm
ASS75310	Ø250 (10")	10 mm	20 mm	36 mm	50 mm
ASS75315	Ø250 (10")	15 mm	30 mm	36 mm	50 mm
ASS75320	Ø250 (10")	20 mm	40 mm	36 mm	50 mm
ASS75325	Ø250 (10")	25 mm	50 mm	36 mm	50 mm
ASS75410	Ø300 (12")	10 mm	20 mm	42 mm	50 mm
ASS75415	Ø300 (12")	15 mm	30 mm	42 mm	50 mm
ASS75420	Ø300 (12")	20 mm	40 mm	42 mm	50 mm
ASS75425	Ø300 (12")	25 mm	50 mm	42 mm	50 mm
ASS75510	Ø350 (14")	10 mm	20 mm	50 mm	50 mm
ASS75515	Ø350 (14")	15 mm	30 mm	50 mm	50 mm
ASS75520	Ø350 (14")	20 mm	40 mm	50 mm	50 mm
ASS75525	Ø350 (14")	25 mm	50 mm	50 mm	50 mm

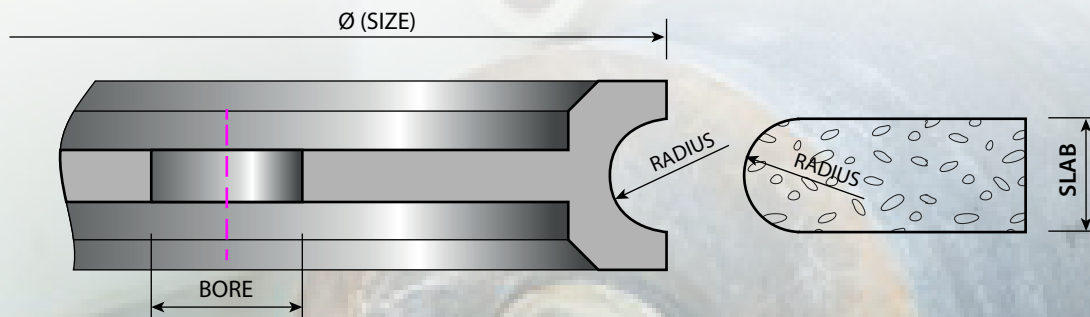

PROFILING WHEELS

flat and profiling tools



SEGMENTED PROFILING WHEELS

Half Bullnose



CODE	SIZE mm	RADIUS	SLAB	SEG SIZE	BORE
ASS71205	Ø200 (8")	5 mm	5 mm	28 mm	50 mm
ASS71210	Ø200 (8")	10 mm	10 mm	28 mm	50 mm
ASS71215	Ø200 (8")	15 mm	15 mm	28 mm	50 mm
ASS71220	Ø200 (8")	20 mm	20 mm	28 mm	50 mm
ASS71225	Ø200 (8")	25 mm	25 mm	28 mm	50 mm
ASS71230	Ø200 (8")	30 mm	30 mm	28 mm	50 mm
ASS71240	Ø200 (8")	40 mm	40 mm	28 mm	50 mm
ASS71310	Ø250 (10")	10 mm	10 mm	36 mm	50 mm
ASS71315	Ø250 (10")	15 mm	15 mm	36 mm	50 mm
ASS71320	Ø250 (10")	20 mm	20 mm	36 mm	50 mm
ASS71325	Ø250 (10")	25 mm	25 mm	36 mm	50 mm
ASS71330	Ø250 (10")	30 mm	30 mm	36 mm	50 mm
ASS71340	Ø250 (10")	40 mm	40 mm	36 mm	50 mm
ASS71410	Ø300 (12")	10 mm	10 mm	42 mm	50 mm
ASS71415	Ø300 (12")	15 mm	15 mm	42 mm	50 mm
ASS71420	Ø300 (12")	20 mm	20 mm	42 mm	50 mm
ASS71425	Ø300 (12")	25 mm	25 mm	42 mm	50 mm
ASS71430	Ø300 (12")	30 mm	30 mm	42 mm	50 mm
ASS71440	Ø300 (12")	40 mm	40 mm	42 mm	50 mm
ASS71510	Ø350 (14")	10 mm	10 mm	51 mm	50 mm
ASS71515	Ø350 (14")	15 mm	15 mm	51 mm	50 mm
ASS71520	Ø350 (14")	20 mm	20 mm	51 mm	50 mm
ASS71525	Ø350 (14")	25 mm	25 mm	51 mm	50 mm
ASS71530	Ø350 (14")	30 mm	30 mm	51 mm	50 mm
ASS71540	Ø350 (14")	40 mm	40 mm	51 mm	50 mm

GR

ES

MR



wet

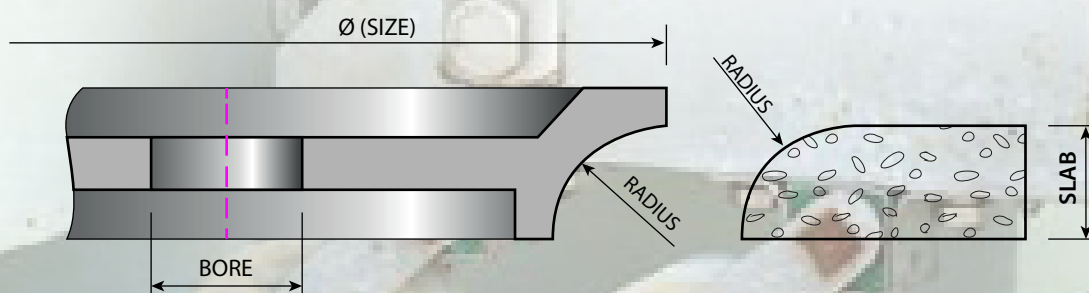



ELECTROPLATED PROFILING WHEELS

Bullnose



CODE	SIZE mm	RADIUS	SLAB	GRIT	BORE
ASE9V222	Ø200 (8")	10 mm	20 mm	40/50	50 mm
ASE9V322	Ø200 (8")	15 mm	30 mm	40/50	50 mm
ASE9V422	Ø200 (8")	20 mm	40 mm	40/50	50 mm
ASE9V822	Ø200 (8")	25 mm	50 mm	40/50	50 mm
ASE9V232	Ø250 (10")	10 mm	20 mm	40/50	50 mm
ASE9V332	Ø250 (10")	15 mm	30 mm	40/50	50 mm
ASE9V432	Ø250 (10")	20 mm	40 mm	40/50	50 mm
ASE9V832	Ø250 (10")	25 mm	50 mm	40/50	50 mm
ASE9V242	Ø300 (12")	10 mm	20 mm	40/50	50 mm
ASE9V342	Ø300 (12")	15 mm	30 mm	40/50	50 mm
ASE9V442	Ø300 (12")	20 mm	40 mm	40/50	50 mm
ASE9V842	Ø300 (12")	25 mm	50 mm	40/50	50 mm
ASE9V252	Ø350 (14")	10 mm	20 mm	40/50	50 mm
ASE9V352	Ø350 (14")	15 mm	30 mm	40/50	50 mm
ASE9V452	Ø350 (14")	20 mm	40 mm	40/50	50 mm
ASE9V852	Ø350 (14")	25 mm	50 mm	40/50	50 mm

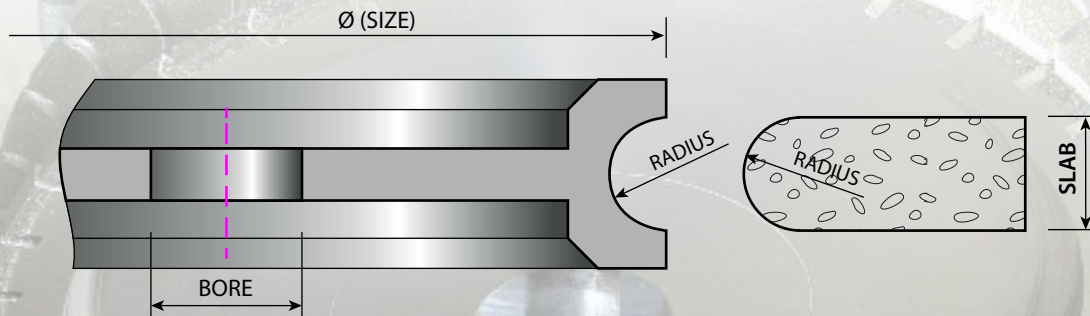

PROFILING WHEELS FOR MARBLE

flat and profiling tools



ELECTROPLATED PROFILING WHEELS

Half Bullnose

CODE	SIZE mm	RADIUS	SLAB	GRIT	BORE
ASE9B122	Ø200 (8")	5 mm	5 mm	40/50	50 mm
ASE9B222	Ø200 (8")	10 mm	10 mm	40/50	50 mm
ASE9B322	Ø200 (8")	15 mm	15 mm	40/50	50 mm
ASE9B422	Ø200 (8")	20 mm	20 mm	40/50	50 mm
ASE9B822	Ø200 (8")	25 mm	25 mm	40/50	50 mm
ASE9B922	Ø200 (8")	30 mm	30 mm	40/50	50 mm
ASE9BA22	Ø200 (8")	40 mm	40 mm	40/50	50 mm
ASE9B232	Ø250 (10")	10 mm	10 mm	40/50	50 mm
ASE9B332	Ø250 (10")	15 mm	15 mm	40/50	50 mm
ASE9B432	Ø250 (10")	20 mm	20 mm	40/50	50 mm
ASE9B832	Ø250 (10")	25 mm	25 mm	40/50	50 mm
ASE9B932	Ø250 (10")	30 mm	30 mm	40/50	50 mm
ASE9BA32	Ø250 (10")	40 mm	40 mm	40/50	50 mm
ASE9B242	Ø300 (12")	10 mm	10 mm	40/50	50 mm
ASE9B342	Ø300 (12")	15 mm	15 mm	40/50	50 mm
ASE9B442	Ø300 (12")	20 mm	20 mm	40/50	50 mm
ASE9B842	Ø300 (12")	25 mm	25 mm	40/50	50 mm
ASE9B942	Ø300 (12")	30 mm	30 mm	40/50	50 mm
ASE9BA42	Ø300 (12")	40 mm	40 mm	40/50	50 mm
ASE9B252	Ø350 (14")	10 mm	10 mm	40/50	50 mm
ASE9B352	Ø350 (14")	15 mm	15 mm	40/50	50 mm
ASE9B452	Ø350 (14")	20 mm	20 mm	40/50	50 mm
ASE9B852	Ø350 (14")	25 mm	25 mm	40/50	50 mm
ASE9B952	Ø350 (14")	30 mm	30 mm	40/50	50 mm
ASE9BA52	Ø350 (14")	40 mm	40 mm	40/50	50 mm

MR

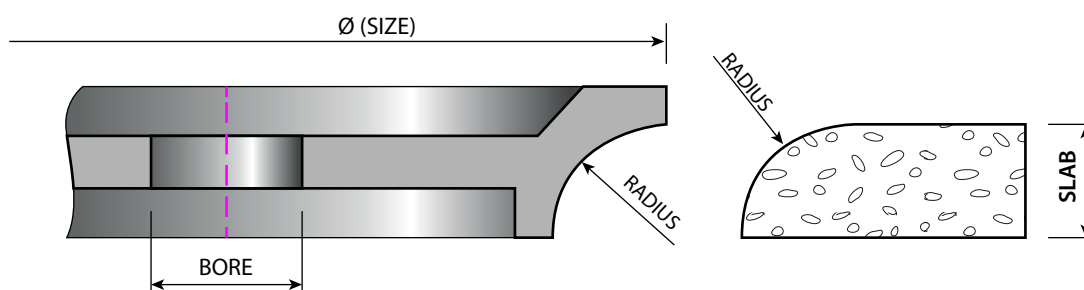



FRAMES & SKIRTING boards

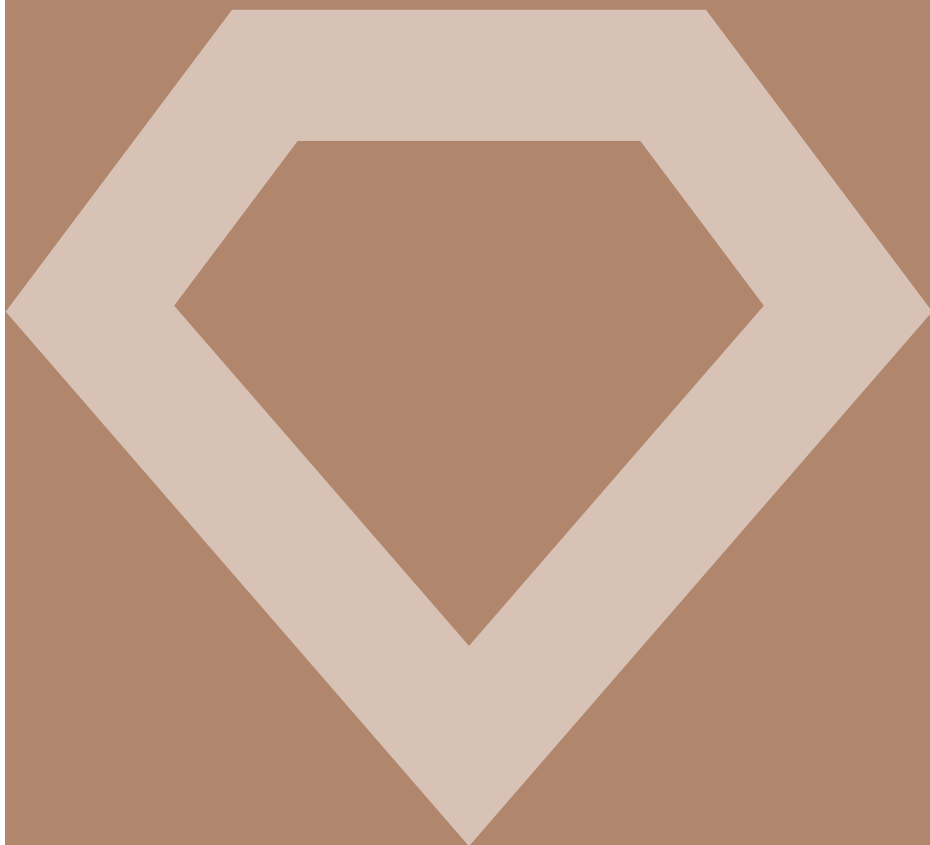

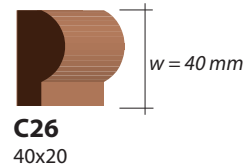
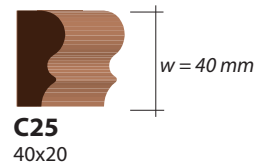
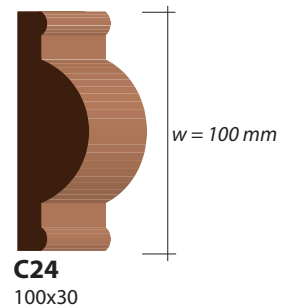
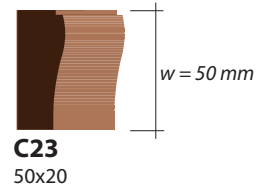
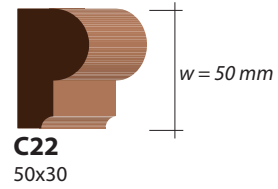
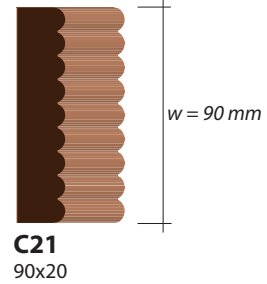
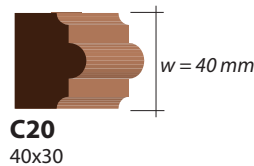
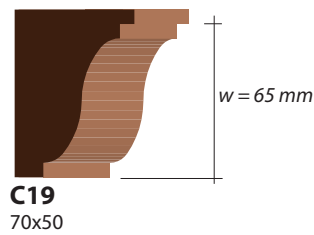
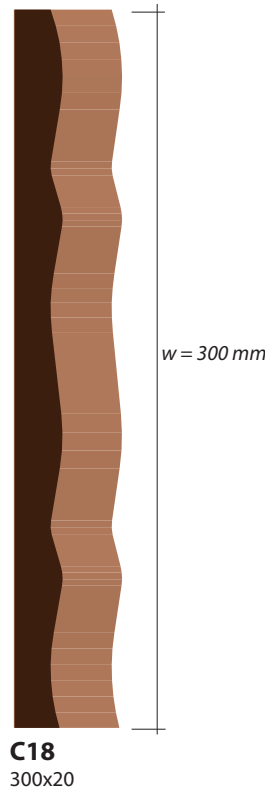
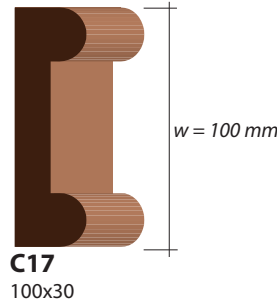
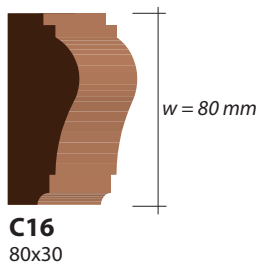
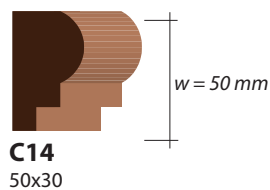
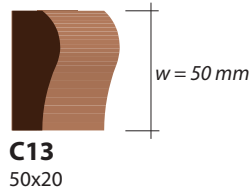
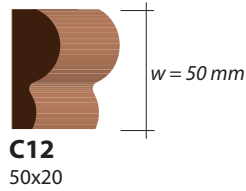
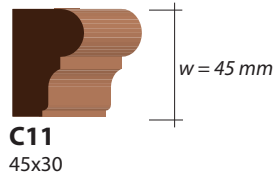
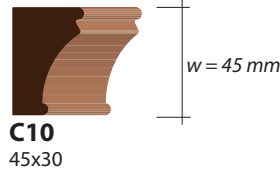
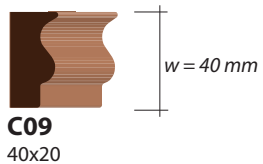
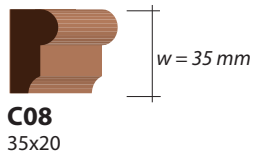
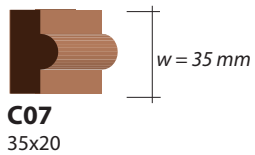
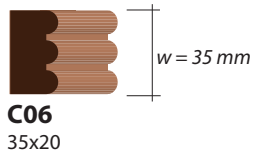
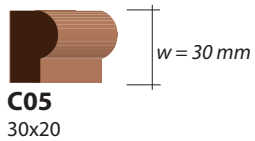
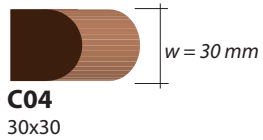
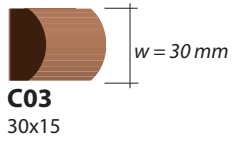
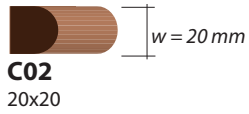
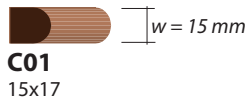

Custom profiles are manufacturable on request

SKIRTING BOARDS PROFILE FOR MARBLE

frames and skirting boards

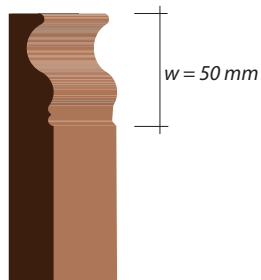

Z01
120x20

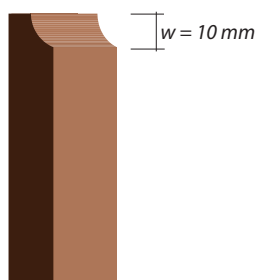

Z05
120x20

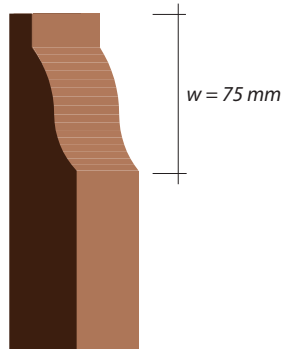

Z09
150x30

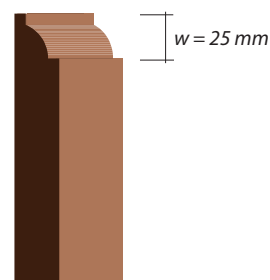

Z13
120x20

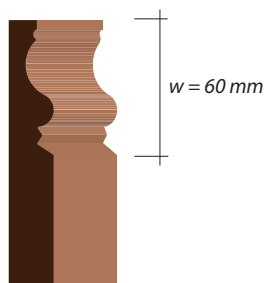

Z02
120x20

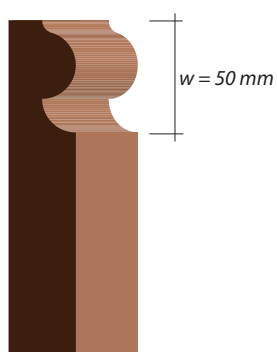

Z06
150x30

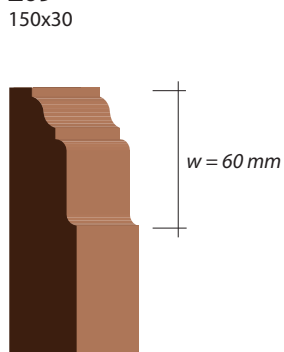

Z10
120x30

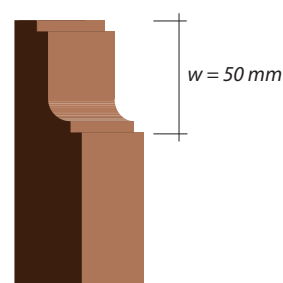

Z14
120x30

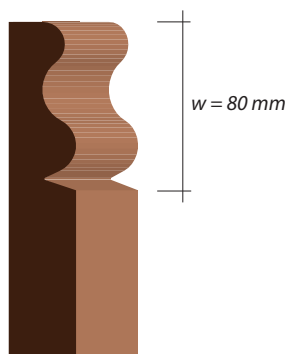

Z03
150x30

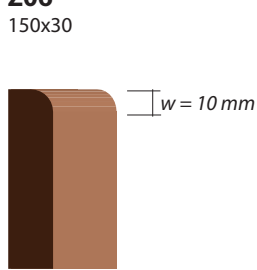

Z07
80x20

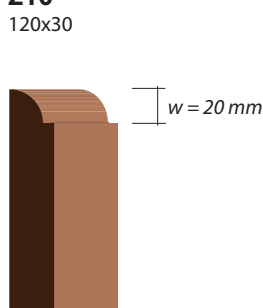

Z11
100x20

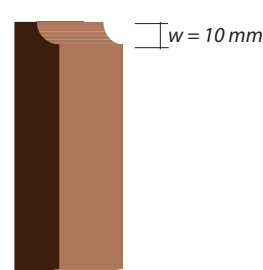

Z15
120x20

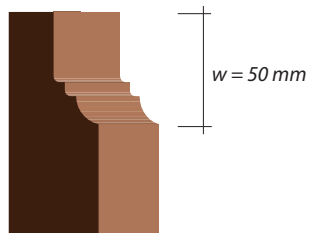

Z04
100x40

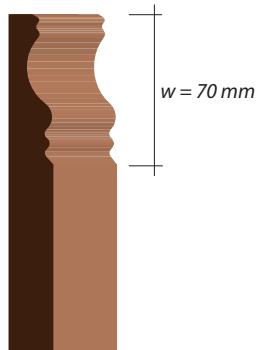

Z08
150x20

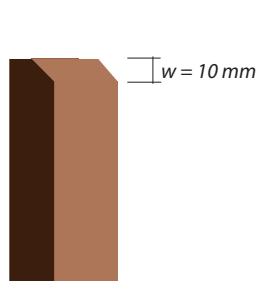

Z12
100x20

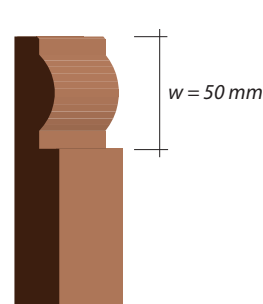

Z16
120x20

Custom profiles are manufacturable on request

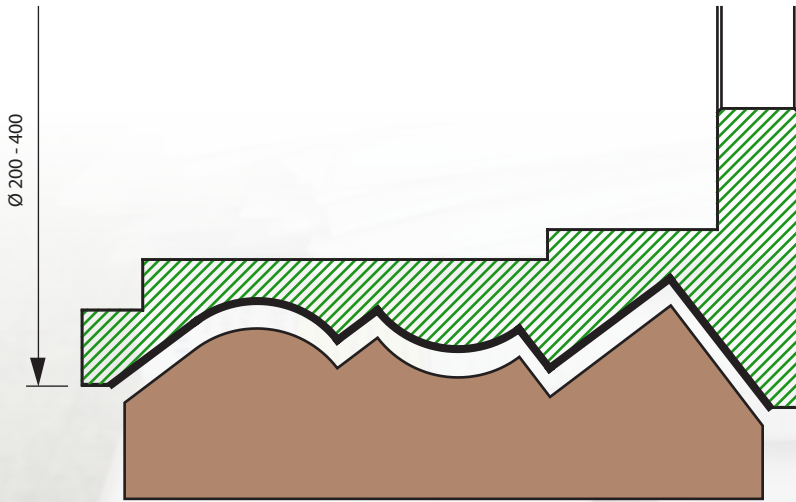

ELECTROPLATED WHEELS

From grit D851 for fastest cutting to grit D46 for finishing

Send us your drawing and we'll propose you the best solution

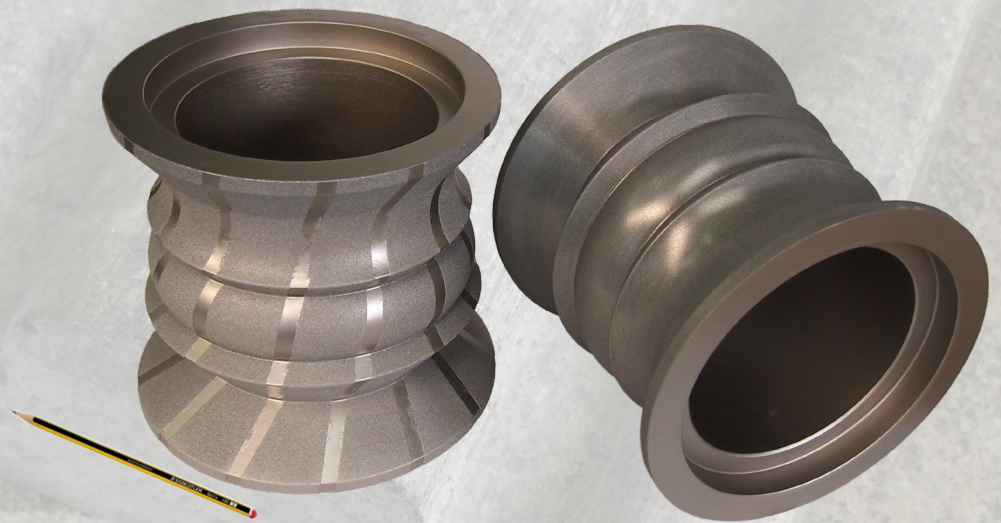



Step 1
Electroplated Bamboo Wheel

CODE	SIZE	DRAWING
DSE6640B	Ø400 (16") x H100 mm B60	Bamboo 01*
DSE5470B	Ø300 (12") x H100 mm B60	Bamboo 01*

**Different Bamboo drawings are available*



Step 2
Sica Brush

Bamboo surface



TERMS & CONDITIONS

PAYMENT TERMS

- ALL PAYMENTS have to be made in the currency indicated on the invoice.
- All invoices are due upon receipt unless stated definitely.
- Outstanding Invoice 30 days or older will be charged 1.5% interest monthly.
- Payment can be done through Bank, our Banks are indicated on the order confirmation. Nicolai Diamant also accepts major credit cards .
- Orders on account with a past due balance will be shipped only with Credit Card payment or advance transfer.

ORDERING

- Orders can be placed over the phone, by fax, by mail. Customer orders need to be accepted by Nicolai Diamant with the issue of an Order Confirmation which will state all the Sales conditions.

SHIPPING

- Unless a preference is indicated by the customer and it is accepted by Nicolai Diamant will ship 'best way'.
- If Nicolai is unable to fill an entire order, partial shipment will be made, unless "Ship Complete" is indicated on order.

FREIGHT

- Customers must inspect shipment immediately.
- Damages or shortages must be reported to the carrier at once, and noted damage on Bill of Lading.
- If package arrive damaged, notify to carrier immediately. Save all packing and cartons for the carrier to inspect.
- Nicolai must be notified of any shortages within 24 Hours of receipt.
- Freight is Ex-works Massa unless differently communicated by Nicolai.
- Additional charges may apply to a factory direct shipment.
- INTERNATIONAL ORDERS: Nicolai welcomes orders from all over the world. Freight Charges are dependent upon weight and dimension of package. A minimum order €100.00 (EURO funds) is required. All duty is paid by the customer.

PRICE CHANGES

- Prices and availability are subject to change without notice.
- Quoted prices are valid for 10 days,
- Nicolai reserves the right to correct pricing errors on any or all print or any electronic media.
- Nicolai reserves the right to limit quantities.

RETURNS

- 30 Day Return Policy for most unused items. Special Orders or customized products cannot be returned. Additional restocking fees may apply.
- All returns need a Return goods Authorization Number (RGA#) from Nicolai. To receive an RGA# contact our main commercial office @ mail@nicolaidiamant.com.
- Returned items must be unused, missing no parts, and be in a resalable condition to receive full credit.
- Custom tools or private label tools are not returnable.

If customer prefers a refund, payment will be in the same form as original payment.

- Items eligible to be returned must be postmarked within 30 days of invoiced date or 45 days from shipping. Items returned after the above set time period, or in non-resalable condition, including marked or damaged manufacturer original packaging, will not be credited. These packages need to be kept in new and resalable condition.
- Once you have received a RGA number, write the RGA number on the packing slip and lg.

Then ship the item to: Nicolai Diamant SRL

Attn: Returns RGA#
via Dorsale 13
54100, Massa (MS)
Italy

- Items returned without a RMA # will be subject to a restocking fee of 20% of the sale price.
- Return of non-stock items will be subject to manufacturer's restocking fee.
- NO RETURNS ON PRINTED MATERIALS, VIDEOS, DVDs, OR SOFTWARE.
- Replacement items will be billed to customer account until credit is issued when the item is received by Nicolai.
- Please note that we will refund shipping costs only if the return is a result of our error,
- All warranty claim are subject to approval for credit by the manufacturer.
- Shipping costs are subject to manufacturers policy.

COMMUNICATION WARRANTY -

PHONE NUMBER: +39 0585 79971 - FAX NUMBER: +39 0585 799799 - EMAIL: mail@nicolaidiamant.com - WEBSITE: www.nicolaidiamant.com

for NICOLAI DIAMANT s.r.l.



NICOLAI IN THE WORLD

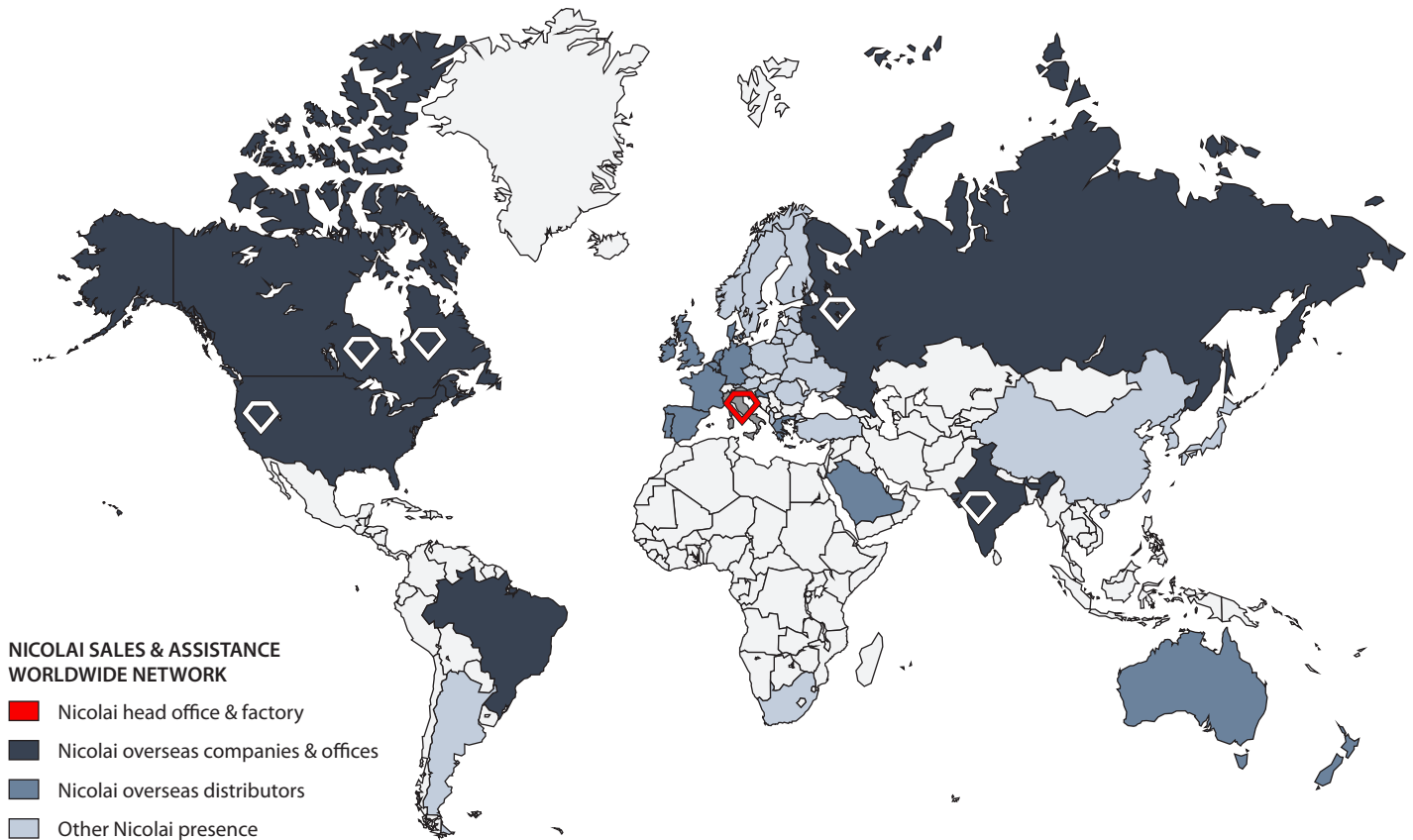

NICOLAI DIAMANT s.r.l. ITALY HEAD OFFICE & FACTORY

via Dorsale 13, lotto 6B, Z.I.
54033 - Massa (MS)

+39 0585 79971
 +39 0585 799799
 mail@nicolaidiamant.com



NICOLAI NORTH AMERICA IT DISTRIBUTING Co., Inc.

Suite #102,
3480 Broadmoor SE, Grand Rapids,
MI 49512

+1 616 855 1550
 +1 616 222 0919
 sales@nicolai-na.com



AMERICAN ABRASIVE TECHNOLOGY

Suite #101,
3480 Broadmoor SE, Grand Rapids,
MI 49512

+1 616 855 1550
 +1 616 222 0919
 info@go-aat.com



NICOLAI RUSSIA BRANCH OFFICE

+7 90578 99959
 mail@nicolai-ru.com



NICOLAI CANADA Diamond Tooling Distribution

100 Bass Pro Mills Dr,
Concord,
ON L4K 5X1

+1 802 661 8731
 mail@nicolai-ca.com

